





SELF-REPAIR HINTS

[bg]	Съвети за ремонт	2
[hr]	Savjeti za popravak	24
[cs]	Poznámky k opravě	46
[da]	Tip til reparation	68
[nl]	Reparatie informatie	90
[en]	Self-repair hints	112
[et]	Remonditeave	134
[fi]	Korjausvinkit	156
[fr]	Conseils de réparation	178
[de]	Reparatur Hinweise	200
[el]	Υποδείξεις επισκευής	222
[hu]	Javítási útmutató	244
[it]	Consigli di riparazione	266
[lv]	Informācija par remontu	288
[lt]	Informacija apie remontą	310
[no]	Reparasjonstips	332
[pl]	Wskazówki naprawy	354
[pt]	Dicas de resolução	376
[ro]	Indicii pentru reparații	398
[sk]	Poznámky k opravám	420
[sl]	Nasveti za popravilo	442
[es]	Consejos de reparación	464
[sv]	Reparationsinformation	486
[tr]	Onarım İpuçları	508

Съвети за ремонт - Перална машина

 Относно този документ	3		
1.1 Важна информация.....	3		
1.1.1 Цел.....	3		
1.2 Обяснение на символите.....	3		
1.2.1 Нива на опасност.....	3		
1.2.2 Символи за опасност.....	3		
1.2.3 Структура на предупрежденията.....	4		
1.2.4 Общи символи.....	4		
 Безопасност	5		
2.1 Общи инструкции за безопасност.....	5		
2.1.1 Всички домашни уреди.....	5		
 Инструменти и помощни средства	6		
 Ремонт	7		
4.1 Смяна на горния работен плот.....	7		
4.1.1 Сваляне на горния работен плот.....	7		
4.1.2 Монтиране на горния работен плот.....	7		
4.2 Смяна на фасадния панел.....	8		
4.2.1 Сваляне на фасадния панел.....	8		
4.2.2 Монтиране на фасадния панел.....	8		
4.3 Смяна на чекмеджето за перилен препарат.....	9		
4.3.1 Сваляне на чекмеджето за перилен препарат.....	9		
4.3.2 Монтиране на чекмеджето за перилен препарат.....	9		
4.4 Смяна на дръжката на чекмеджето за перилен препарат.....	10		
4.4.1 Сваляне на дръжката на чекмеджето за перилен препарат.....	10		
4.4.2 Монтиране на дръжката на чекмеджето за перилен препарат.....	10		
4.5 Смяна на вратата.....	11		
4.5.1 Изваждане на вратата.....	11		
4.5.2 Монтиране на вратата.....	11		
4.6 Смяна на компонентите на вратата.....	12		
4.6.1 Сваляне на компонентите на вратата.....	12		
4.6.2 Монтиране на компонентите на вратата.....	12		
4.7 Смяна на уплътнението на вратата.....	13		
4.7.1 Сваляне на уплътнението на вратата.....	13		
4.7.2 Монтиране на уплътнението на вратата.....	16		
4.8 Смяна на ключа на вратата.....	17		
4.8.1 Сваляне на ключалката на вратата.....	17		
4.8.2 Монтиране на ключалката на вратата.....	18		
4.9 Смяна на осветлението на барабана.....	19		
4.9.1 Сваляне на осветлението на барабана.....	19		
4.9.2 Монтиране на осветлението на барабана.....	19		
4.10 Смяна на капака на помпата.....	20		
4.10.1 Сваляне на капака на помпата.....	20		
4.10.2 Монтиране на капака на помпата.....	20		
4.11 Смяна на предния панел.....	21		
4.11.1 Сваляне на предния панел.....	21		
4.11.2 Монтиране на предния панел.....	23		

i Относно този документ

1.1 Важна информация

1.1.1 Цел

Тези съвети за ремонт помагат на потребителя да ремонтира сам уреди в съответствие с регламента за екологосъобразно проектиране на уредите (от 03.2021 г.).

Те съдържат информация как да сменят определени резервни части, включително предупреждения и рискове.

Ако имате някакви въпроси, моля свържете се с нашия отдел за обслужване на клиенти. Носим отговорност за щети, само ако съветите за ремонт са спазени правилно.

1.2 Обяснение на символите

1.2.1 Нива на опасност

Предупредителните нива се състоят от символ и сигнална дума. Сигналната дума показва сериозността на опасността.





Ниво на предупреждение	Значение
 ОПАСНОСТ	Неспазването на предупредителното съобщение ще доведе до смърт или сериозни наранявания.
 ПРЕДУПРЕЖДЕНИЕ	Неспазването на предупредителното съобщение може да доведе до смърт или сериозни наранявания.
 ВНИМАТЕЛНО	Неспазването на предупредителното съобщение може да доведе до леки наранявания.
 ВНИМАНИЕ!	Неспазването на предупредителното съобщение може да доведе до имуществени щети.

Таблица 1: Нива на опасност

1.2.2 Символи за опасност

Символите за опасност са символични изображения, които дават индикация за вида опасност.

В този документ се използват следните символи за опасност:

Символ за опасност	Значение
	Общо предупредително съобщение
	Опасност от електрическо напрежение
	Риск от експлозия
	Опасност от порязвания

i Относно този документ





Символ за опасност	Значение
	Опасност от премазване
	Опасност от горещи повърхности
	Опасност от силно магнитно поле
	Опасност от нейонизиращо лъчение

Таблица 2: Символи за опасност

1.2.3 Структура на предупрежденията

Предупрежденията в този документ имат стандартизиран външен вид и стандартизирана структура.

	<p>ОПАСНОСТ</p> <p>Вид и източник на опасността! Възможни последици от игнориране на опасността/предупреждението.</p> <ul style="list-style-type: none"> ▶ Мерки и забрани за предотвратяване на опасността.
--	---

Следният пример показва предупреждение, което уведомява за токов удар, предизвикан от части под напрежение. Споменава се мярката за избягване на опасността.

	<p>ОПАСНОСТ</p> <p>Риск от токов удар поради части под напрежение! Смърт от токов удар</p> <ul style="list-style-type: none"> ▶ Изключете уредите от електрическото захранване поне 60 секунди преди започване на ремонта.
--	---

1.2.4 Общи символи

В този документ се използват следните общи символи:







Общ символ	Значение
	Идентифициране на специален съвет (текст и/или графика)
	Идентифициране на прост съвет (само текст)
	Идентифициране на връзка към видео урок
	Идентифициране на необходимите инструменти
	Идентифициране на необходимите предварителни условия
	Идентифициране на условие (ако ..., тогава ...)
	Идентифициране на резултат
Старт	Идентифициране на ключ или бутон
[00123456]	Идентифициране на каталожен номер
Статус	Идентифициране на показания текст/прозорец (на дисплея на уреда)

Таблица 3: Общи символи

2.1 Общи инструкции за безопасност

2.1.1 Всички домашни уреди

Риск от токов удар поради части под напрежение!

- Грешки при ремонти, включващи електрически компоненти, могат да доведат до токов удар!
- Разкачете уреда от електрическата мрежа за поне 60 секунди, преди да започнете работа.
- След ремонта трябва да се извърши проверка за безопасност съгласно VDE 0701 или в съответствие със специфичните за страната разпоредби.

Риск от нараняване от остри ръбове!

- Носете предпазни ръкавици.

Риск от премазване по време на ремонт, поддръжка, отстраняване на неизправности и сервиз поради тежки и движещи се компоненти

- Носете защитни обувки.
- Закрепете тежките компоненти, така че да не паднат.
- Не позволявайте контакт на части от тялото с движещи се компоненти.







Риск за безопасността/функцията на уреда!

- Използвайте само оригинални резервни части.

Риск от повреда на електростатично чувствителни компоненти (ESD)!

- Не докосвайте модулите, включително връзки и проводникови пътища.

Инструменти и помощни средства

посочване	Подробности	Изображения
Помощен инструмент [15000155]	Инструмент за разхлабване на пластмасови части	
Отвертка Torx T20 с отвор [00340764]	100 мм, за винтове с предпазен щифт	
Динамометричен ключ [15000441]	Динамометричен ключ 20 - 100 Nm	
Плоска отвертка [00340854]	Врх 3,5 mm x 0,6 mm x 100 mm, Защитна изолация 1000 V AC	
Плоска отвертка [00340855]	Врх 5,5 mm x 1,0 mm x 125 mm, Защитна изолация 1000 V AC	
Клещи с игловидни челюсти, под ъгъл [00341269]	Дължина 200 мм	
Клещи резачки [00342182]	Дължина: 200 мм	



посочване	Подробности	Изображения
Комбиниран ключ [00340811]	гаечния ключ 10°mm, M6	
Combination wrench [00340814]	гаечния ключ 13°mm, M8	
Комбиниран ключ [00340817]	гаечния ключ 17 mm, M10	
Комбиниран ключ [15000459]	гаечния ключ 16°mm, M10	

4.1 Смяна на горния работен плот

Специални инструменти:

-  Накрайник Torx TX20 с отвор, 6,3°мм (1/4") 152°мм, за винтове с дълъг предпазен щифт [00341272]

Изискване:

-  Уредът е изключен от захранването.
-  Уредът е изключен от водоснабдителната мрежа.

4.1.1 Сваляне на горния работен плот

- ▶ 1. Свалете винтовете (1).
- ▶ 2. Избутайте горния работен плот към задния край на уреда (2).
- ▶ 3. Преместете горния работен плот нагоре (3), за да го свалите.

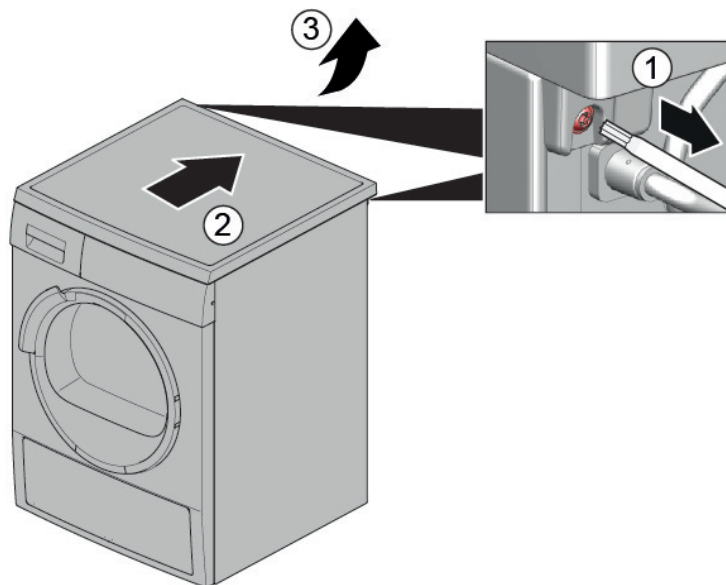

4.1.2 Монтиране на горния работен плот

- ▶ Монтирайте в обратен ред.

4.2 Смяна на фасадния панел



ВНИМАТЕЛНО

Остри ръбове на корпуса!
Наранявания от порязване
▶ Носете предпазни ръкавици.



ПРЕДУПРЕЖДЕНИЕ

Приплъзване на наклонени уреди!
Костни фрактури/наранявания от премазване
▶ Укрепете уредите срещу приплъзване.



ВНИМАТЕЛНО





Риск от падащи части поради разхлабени винтове!
Нараняване поради падащи части.
▶ Закрепете компонента, така че да не падне.



ВНИМАНИЕ!

Риск от падащи части поради разхлабени винтове!
Повреда на други части на уреда или в дома на клиента, напр. дъното.
▶ Закрепете компонента, така че да не падне.

Изискване:

-  Уредът е изключен от захранването.
-  Уредът е изключен от водоснабдителната мрежа.
-  [Горният работен плот е свален.→7](#)
-  [Чекмеджето за перилния препарат е свалено.→9](#)

4.2.1 Сваляне на фасадния панел

1. 1. Свалете винтовете (1).
2. Освободете крепежните елементи (2, 3).

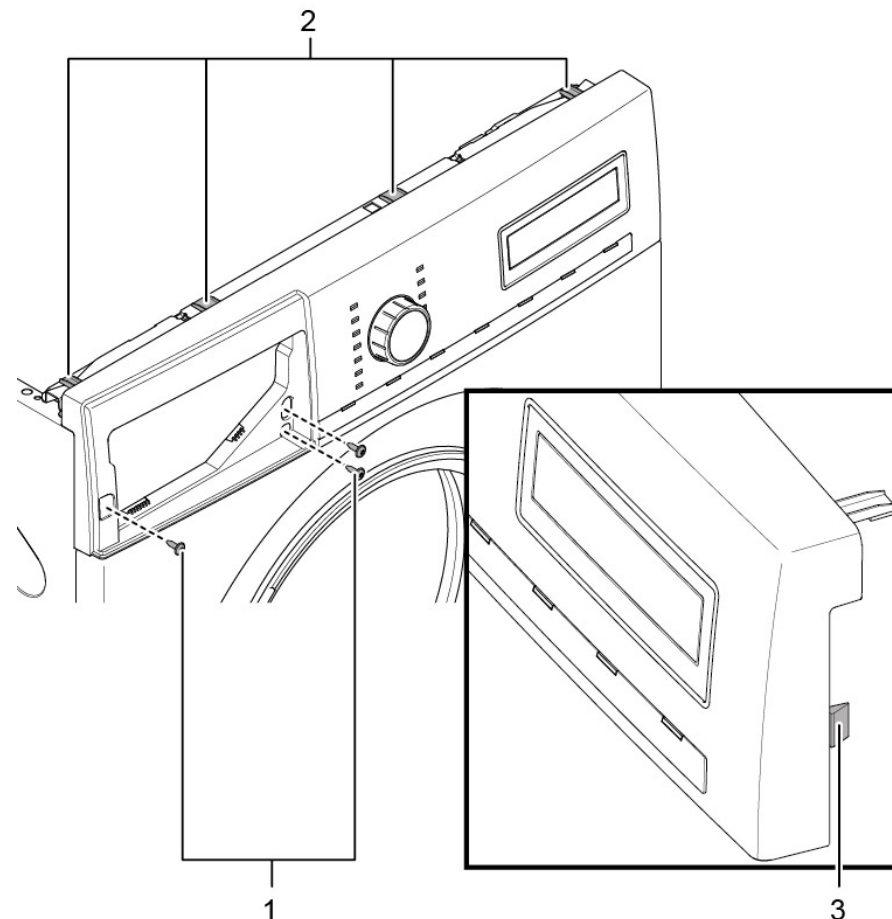

2. Освободете щепселното съединение на контролния блок.
3. Свалете фасадния панел.

4.2.2 Монтиране на фасадния панел

- ▶ Монтирайте в обратен ред.

4.3 Смяна на чекмеджето за перилен препарат

Изискване:

- ✓ Уредът е изключен от захранването.
- ✓ Уредът е изключен от водоснабдителната мрежа.

4.3.1 Сваляне на чекмеджето за перилен препарат

1. Изтеглете чекмеджето за перилен препарат.
2. 1. Натиснете надолу върху подложката (1).
2. Свалете чекмеджето за перилен препарат (2).

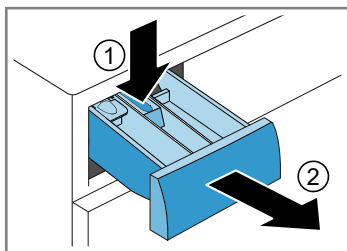

4.3.2 Монтиране на чекмеджето за перилен препарат

- ▶ Монтирайте в обратен ред.

4.4 Смяна на дръжката на чекмеджето за перилен препарат

Изискване:

- ✓ Уредът е изключен от захранването.
- ✓ Уредът е изключен от водоснабдителната мрежа.
- ✓ [Чекмеджето за перилния препарат е свалено.→9](#)

4.4.1 Сваляне на дръжката на чекмеджето за перилен препарат

1. Освободете крепежните елементи.

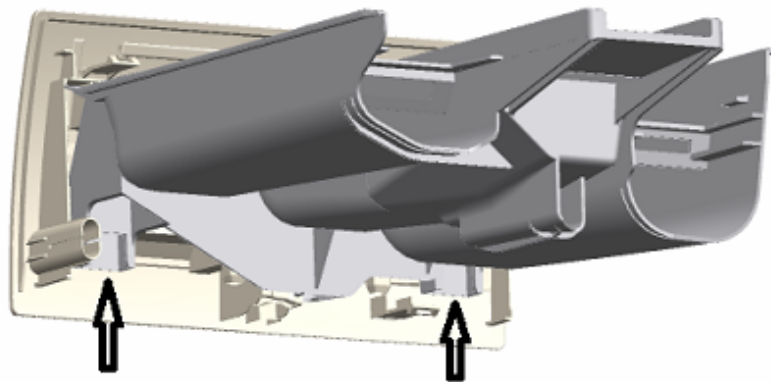

2. Свалете дръжката на чекмеджето за перилен препарат.

4.4.2 Монтиране на дръжката на чекмеджето за перилен препарат

- ▶ Монтирайте в обратен ред.

4.5 Смяна на вратата



ВНИМАТЕЛНО

Отворете областта на пантите!

Премазване/захващане на пръстите

- ▶ Не посягайте към областта на пантите.
- ▶ Носете предпазни ръкавици.

Изискване:

- ✔ Уредът е изключен от захранването.
- ✔ Уредът е изключен от водоснабдителната мрежа.
- ✔ Вратата е отворена.

4.5.1 Изваждане на вратата

1.



ВНИМАНИЕ!

Риск от падащи части поради разхлабени винтове!

Повреда на други части на уреда или в дома на клиента, напр. дъното.

- ▶ Закрепете компонента, така че да не падне.



ВНИМАТЕЛНО

Риск от падащи части поради разхлабени винтове!

Нараняване поради падащи части.

- ▶ Закрепете компонента, така че да не падне.

Свалете винтовете (1).

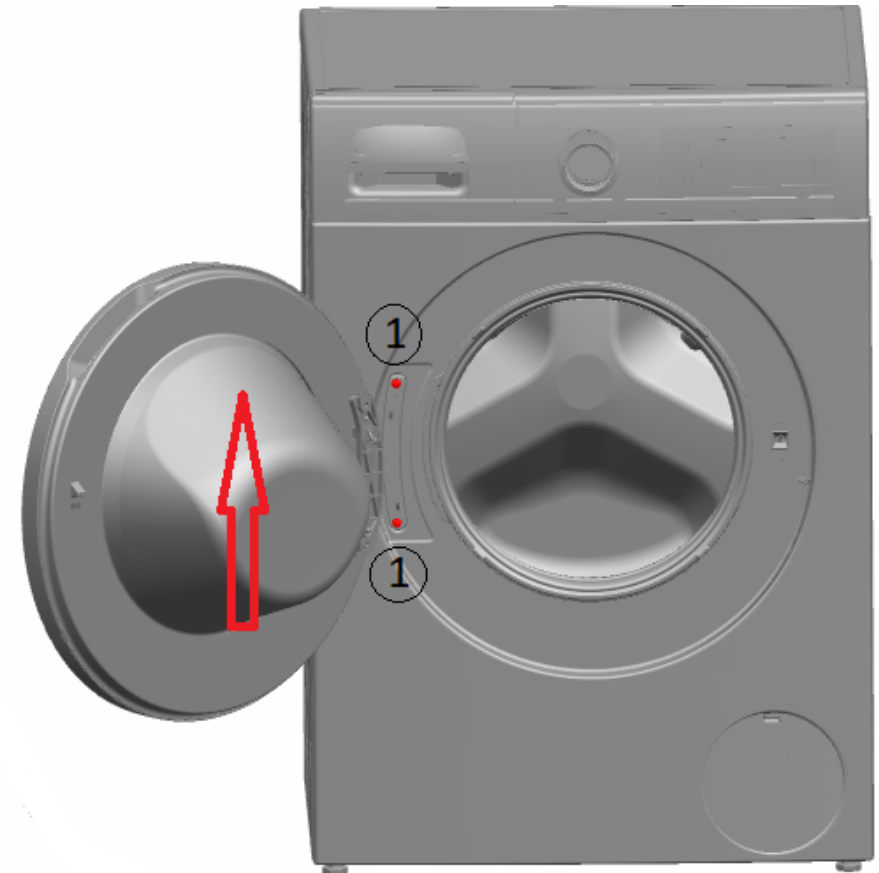

2. Извадете вратата нагоре.

4.5.2 Монтиране на вратата

- ▶ Монтирайте в обратен ред.

4.6 Смяна на компонентите на вратата

	<p>⚠ ВНИМАТЕЛНО</p> <p>Отворете областта на пантите! Премазване/захващане на пръстите</p> <ul style="list-style-type: none">▶ Не посягайте към областта на пантите.▶ Носете предпазни ръкавици.
--	--

Изискване:

- ✔ Уредът е изключен от захранването.
- ✔ Уредът е изключен от водоснабдителната мрежа.
- ✔ [Вратата е свалена.→11](#)

4.6.1 Сваляне на компонентите на вратата

- ▶ Разглобете вратата отвън навътре.

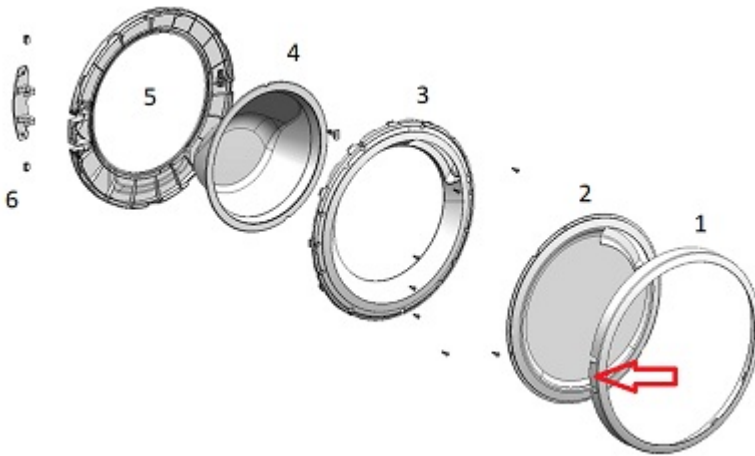



4.6.2 Монтиране на компонентите на вратата

- ▶ Монтирайте в обратен ред.

4.7 Смяна на уплътнението на вратата

	<p>⚠ ВНИМАТЕЛНО</p> <p>Остри ръбове на корпуса! Наранявания от порязване</p> <ul style="list-style-type: none"> ▶ Носете предпазни ръкавици.
--	---

	<p>⚠ ВНИМАТЕЛНО</p> <p>Риск от падащи части поради разхлабени винтове! Нараняване поради падащи части.</p> <ul style="list-style-type: none"> ▶ Закрепете компонента, така че да не падне.
--	---

	<p>ВНИМАНИЕ!</p> <p>Риск от падащи части поради разхлабени винтове! Повреда на други части на уреда или в дома на клиента, напр. дъното.</p> <ul style="list-style-type: none"> ▶ Закрепете компонента, така че да не падне.
--	---

Изискване:

- ✓ Уредът е изключен от захранването.
- ✓ Уредът е изключен от водоснабдителната мрежа.
- ✓ [Чекмеджето за перилния препарат е свалено.→9](#)
- ✓ [Вратата е свалена.→11](#)
- ✓ [Капакът на помпата е свален.→20](#)

4.7.1 Сваляне на уплътнението на вратата

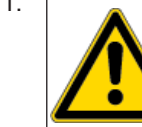
	<p>⚠ ПРЕДУПРЕЖДЕНИЕ</p> <p>Приплъзване на наклонени уреди! Костни фрактури/наранявания от премазване</p> <ul style="list-style-type: none"> ▶ Укрепете уредите срещу приплъзване.
--	--

Повдигнете уреда отпред.

2. Разхлабете винтовете в долната част на предния панел (1).

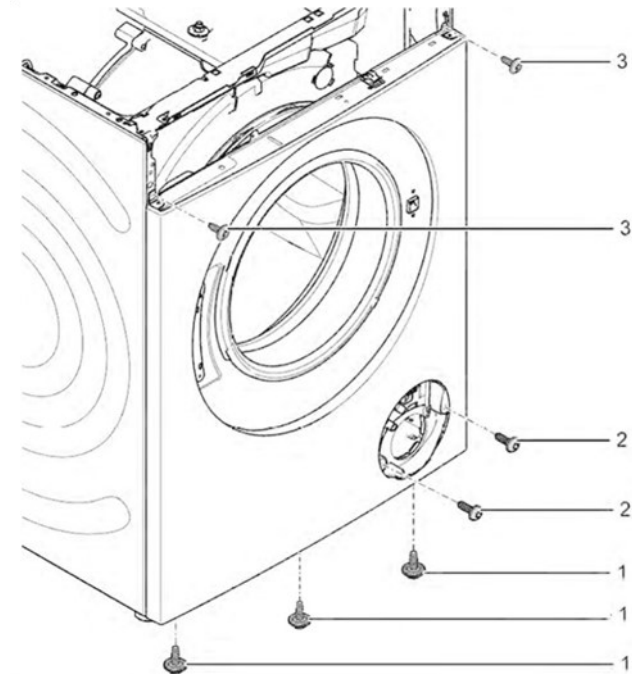

3. Спуснете уреда надолу.

4. Отстранете винтовете в областта на помпата (2).

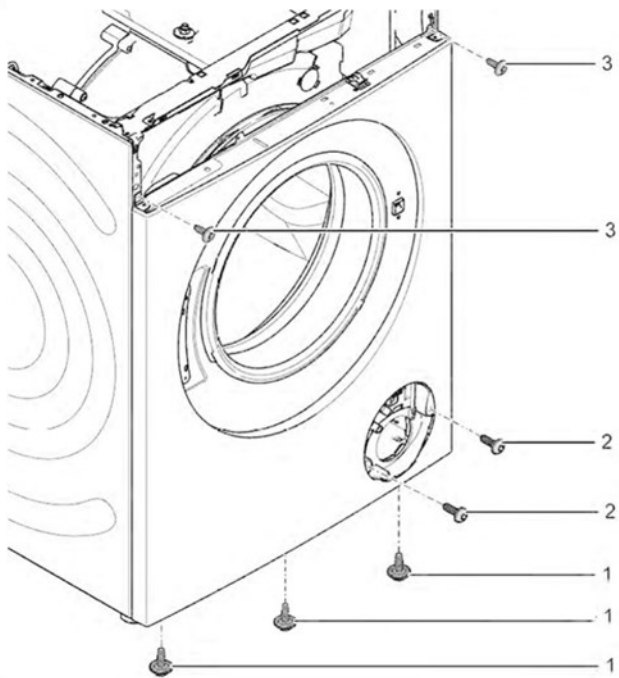

5. 1. Разхлабете винтовете отзад на уреда (1).
2. Свалете горния работен плот (2, 3).

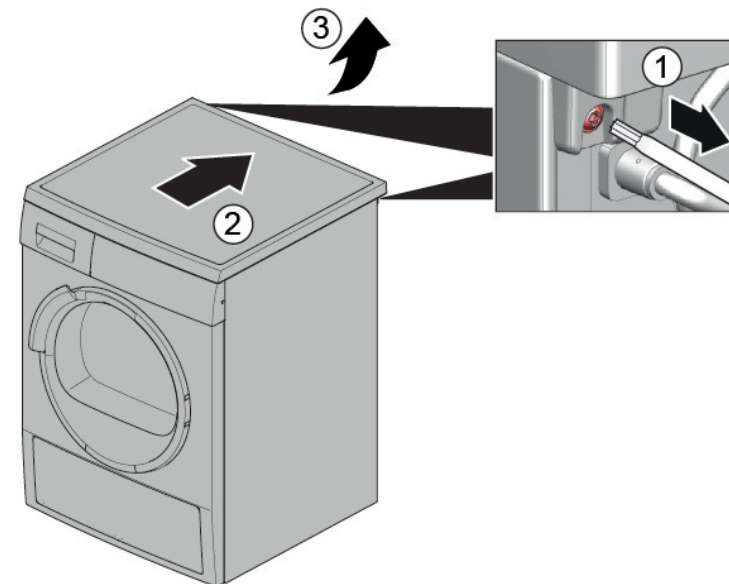

6. 1. Свалете винтовете (1).
2. Освободете крепежните елементи на фасадния панел (2, 3).
3. Разхлабете винтовете на корпуса на дозатора.

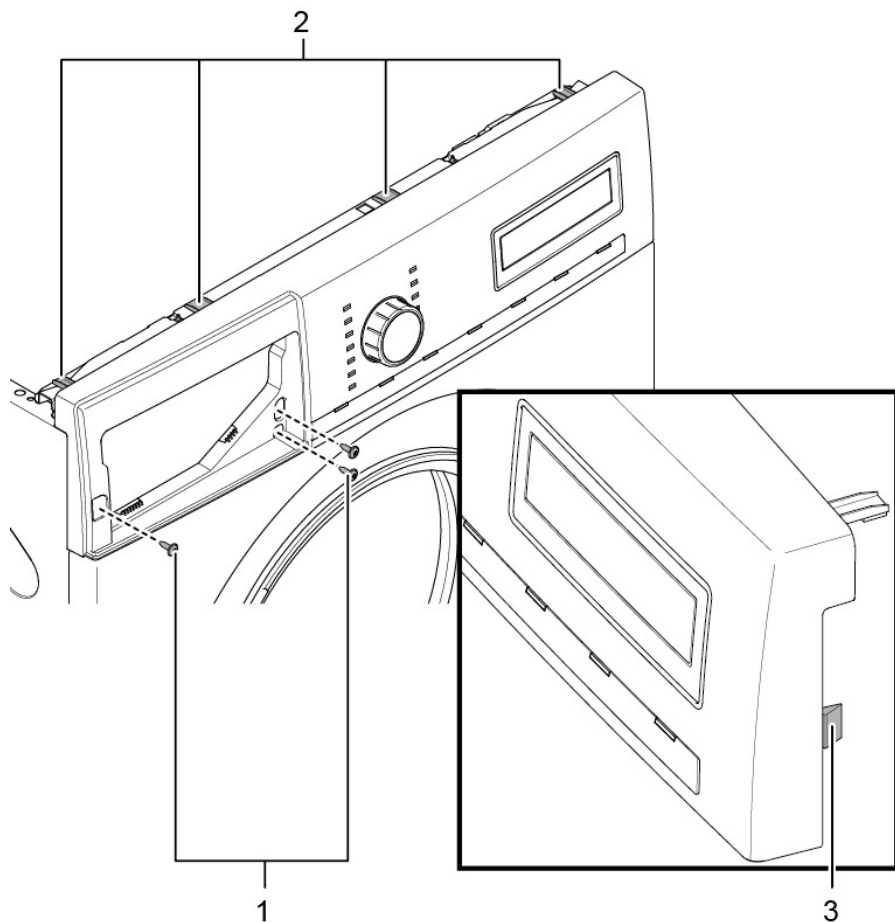

7. Свалете фасадния панел.

8. Свалете държача на осветлението на барабана отгоре.

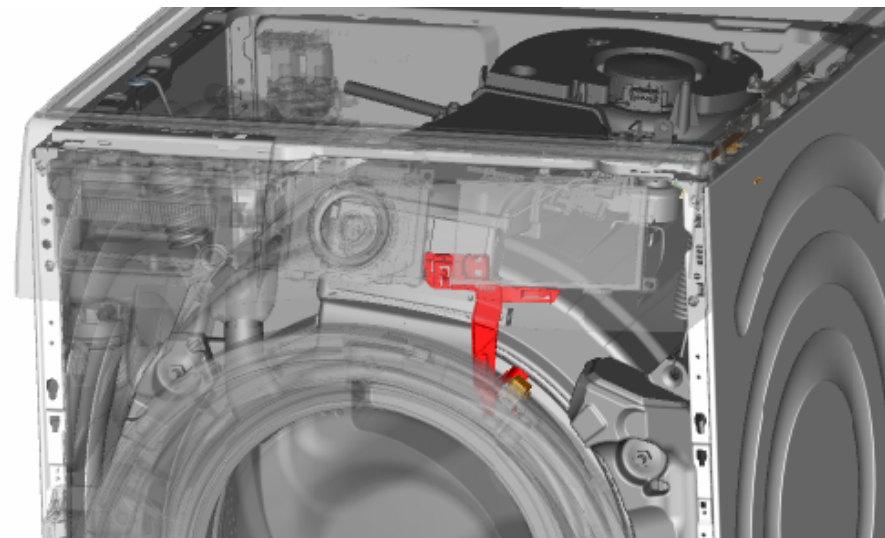

9.

	<p>ВНИМАНИЕ! Риск от повредена повърхност! Повърхността на уреда може да се надраска, ако използвате неправилни инструменти. ▶ Използвайте само пластмасови инструменти за подмяна на обтягащия пръстен.</p>
---	--

Свалете обтягащия пръстен от уплътнението с пластмасов инструмент.

10. Освободете уплътнението на вратата от предния панел.
11. Освободете конектора на кабела от ключалката на вратата.

12. Разхлабете винтовете в горната част на предния панел (3).

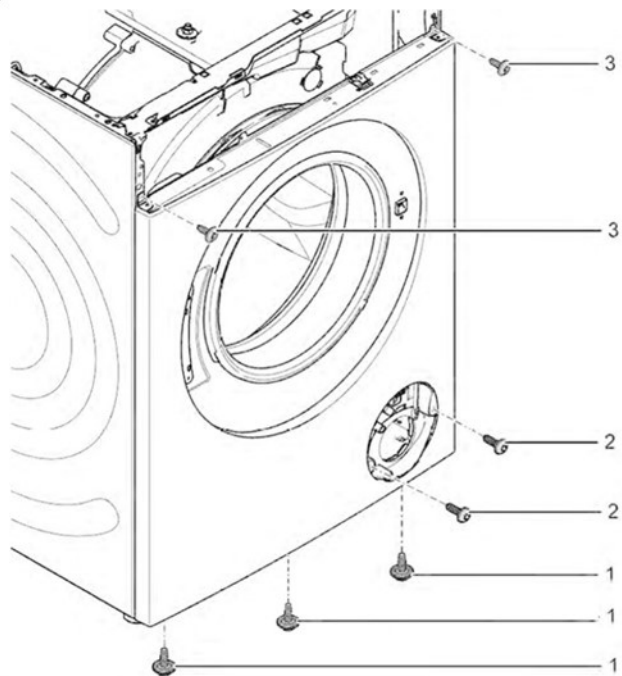

13. Свалете предния панел.

14. Освободете всички съединителни елементи за маркучи.

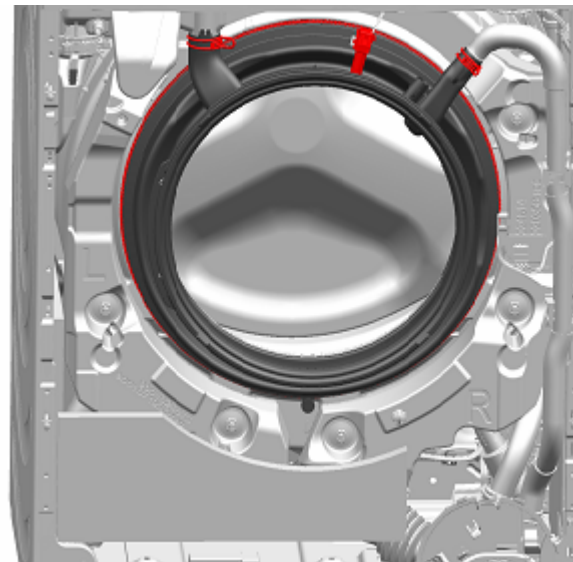

15. Извадете уплътнението на вратата.

4.7.2 Монтиране на уплътнението на вратата



ПРЕДУПРЕЖДЕНИЕ

Риск от падащи части поради неправилен монтаж!

Нараняване или повреждане на уреда.

- ▶ Натегнете притискащия пръстен на уплътнението на вратата с 3,4 Nm.

- ▶ Монтирайте в обратен ред.

4.8 Смяна на ключа на вратата

Като производител ние сме задължени да предоставим на потребителите като резервна част ключалка за вратата, включително инструкция за ремонт в съответствие с Регламента (ЕС) 2019/2023. Бихме искали да отбележим обаче, че след смяната на ключалката на вратата, е необходимо да се извърши електротехническа проверка за безопасност от квалифициран електротехник, преди уредът да бъде пуснат в експлоатация. Това лице трябва да бъде с потвърдена квалификация съгласно специфичните за страната закони, разпоредби и стандарти.

	⚠ ОПАСНОСТ
	<p>Риск от токов удар поради части под напрежение! Опасност за живота от токов удар в случай на неправилен ремонт</p> <ul style="list-style-type: none"> ▶ Електрическите части трябва да се ремонтират от квалифицирани електротехници. ▶ След ремонта трябва да се извърши проверка за безопасност съгласно VDE 0701 или в съответствие със специфичните за страната разпоредби.

	⚠ ВНИМАТЕЛНО
	<p>Остри ръбове на корпуса! Наранявания от порязване</p> <ul style="list-style-type: none"> ▶ Носете предпазни ръкавици.

	⚠ ПРЕДУПРЕЖДЕНИЕ
	<p>Приплъзване на наклонени уреди! Костни фрактури/наранявания от премазване</p> <ul style="list-style-type: none"> ▶ Укрепете уредите срещу приплъзване.

	⚠ ВНИМАТЕЛНО
	<p>Риск от падащи части поради разхлабени винтове! Нараняване поради падащи части.</p> <ul style="list-style-type: none"> ▶ Закрепете компонента, така че да не падне.

	ВНИМАНИЕ!
	<p>Риск от падащи части поради разхлабени винтове! Повреда на други части на уреда или в дома на клиента, напр. дъното.</p> <ul style="list-style-type: none"> ▶ Закрепете компонента, така че да не падне.

Изискване:

- ✓ Уредът е изключен от захранването.
- ✓ Уредът е изключен от водоснабдителната мрежа.
- ✓ Уредите са свободно достъпни.
- ✓ [Горният работен плот е свален.→7](#)
- ✓ Фасадният панел е свален.
- ✓ [Вратата е свалена.→11](#)
- ✓ Обтягащият пръстен е свален.
- ✓ Предният панел е свален.
- ✓ Уплътнението на вратата е свалено.

4.8.1 Сваляне на ключалката на вратата

1. Изключете щепсела на ключалката на вратата.
2. Освободете ключалката на вратата.



3. Свалете ключалката на вратата.



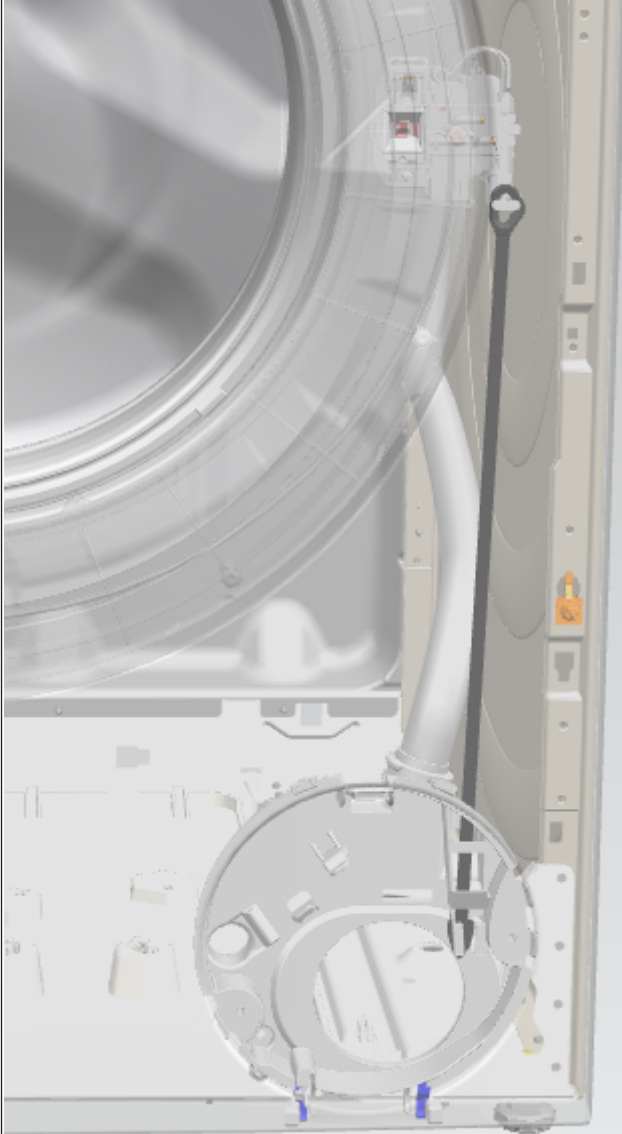

4.8.2 Монтиране на ключалката на вратата

Ключалката на вратата трябва да е в правилното положение, за да осигури функцията за аварийно отваряне на вратата на уреда.



- ▶ Монтирайте в обратен ред.

4.9 Смяна на осветлението на барабана

	⚠ ВНИМАТЕЛНО Остри ръбове на корпуса! Наранявания от порязване ▶ Носете предпазни ръкавици.
	⚠ ПРЕДУПРЕЖДЕНИЕ Приплъзване на наклонени уреди! Костни фрактури/наранявания от премазване ▶ Укрепете уредите срещу приплъзване.
	⚠ ВНИМАТЕЛНО Риск от падащи части поради разхлабени винтове! Нараняване поради падащи части. ▶ Закрепете компонента, така че да не падне.
	ВНИМАНИЕ! Риск от падащи части поради разхлабени винтове! Повреда на други части на уреда или в дома на клиента, напр. дъното. ▶ Закрепете компонента, така че да не падне.

Изискване:

- ✔ Уредът е изключен от захранването.
- ✔ Уредът е изключен от водоснабдителната мрежа.
- ✔ Уредите са свободно достъпни.
- ✔ [Горният работен плот е свален.→7](#)
- ✔ [Чекмеджето за перилния препарат е свалено.→9](#)
- ✔ Фасадният панел е свален.

4.9.1 Сваляне на осветлението на барабана

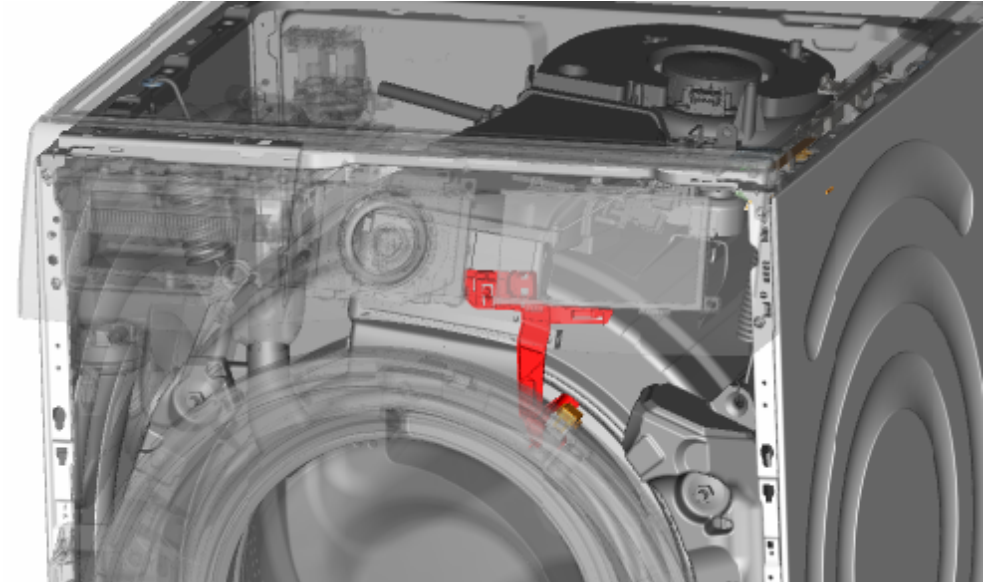

1. Издърпайте държача на осветлението на барабана от уреда.
2. Изключете електрическите връзки.
3. Свалете осветлението на барабана от държача.

4.9.2 Монтиране на осветлението на барабана

- ▶ Монтирайте в обратен ред.

4.10 Смяна на капака на помпата

Изискване:

- ✓ Уредът е изключен от захранването.
- ✓ Уредът е изключен от водоснабдителната мрежа.

4.10.1 Сваляне на капака на помпата

1. Отворете капака на помпата.

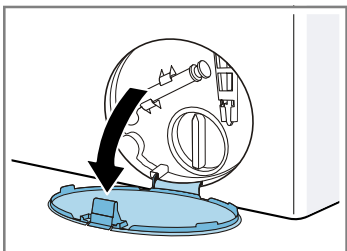

2. Свалете капака на помпата.

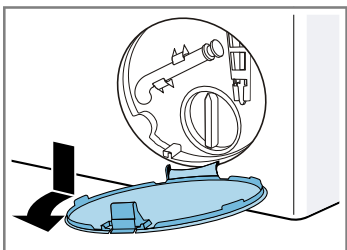

4.10.2 Монтиране на капака на помпата

- ▶ Монтирайте в обратен ред.

4.11 Смяна на предния панел



⚠ ВНИМАТЕЛНО

Остри ръбове на корпуса!

Наранявания от порязване
▶ Носете предпазни ръкавици.

Изискване:

- ✓ Уредът е изключен от захранването.
- ✓ Уредът е изключен от водоснабдителната мрежа.
- ✓ [Чекмеджето за перилния препарат е свалено.→9](#)
- ✓ [Вратата е свалена.→11](#)
- ✓ Уплътнението на вратата е свалено.
- ✓ [Капакът на помпата е свален.→20](#)

4.11.1 Сваляне на предния панел

1.



⚠ ПРЕДУПРЕЖДЕНИЕ

Приплъзване на наклонени уреди!

Костни фрактури/наранявания от премазване
▶ Укрепете уредите срещу приплъзване.

Повдигнете уреда отпред.

2. Свалете винтовете отдолу (1).

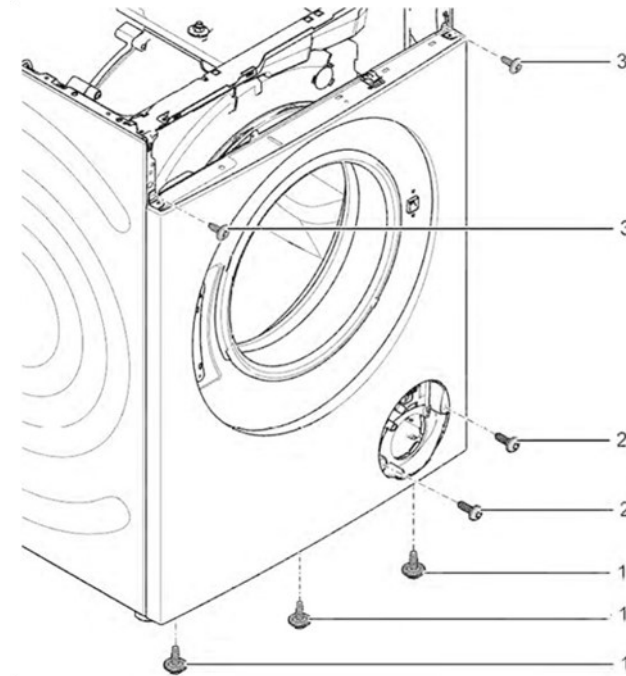

3. Спуснете уреда надолу.

4. 1. Свалете винтовете (1).
2. Избутайте горния работен плот към задния край на уреда (2).
3. Преместете горния работен плот нагоре (3), за да го свалите.

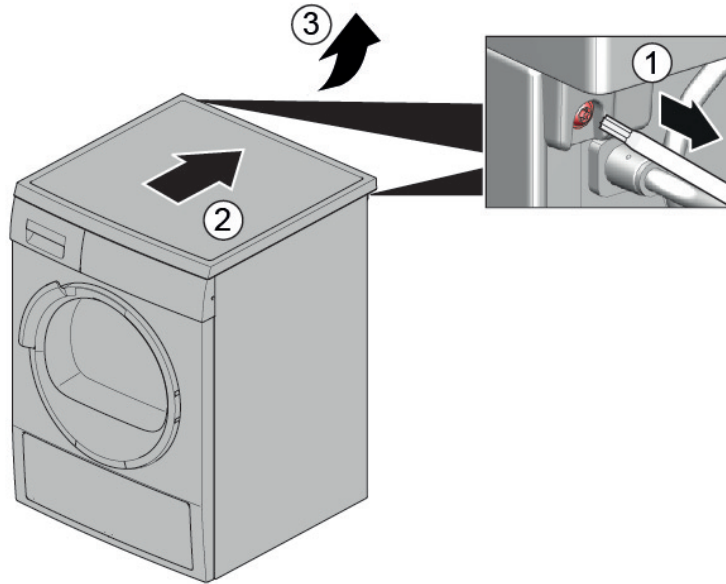

5. 1. Свалете винтовете (1).
2. Освободете крепежните елементи (2, 3).

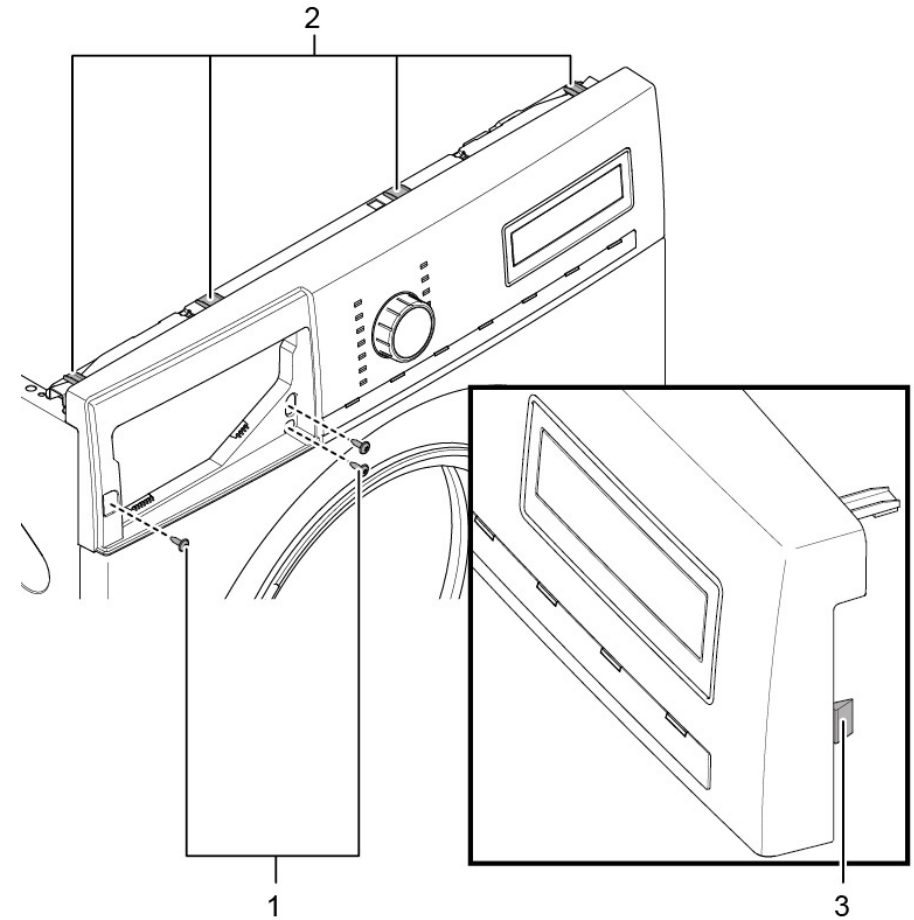

6. Свалете фасадния панел.

7.



⚠ ВНИМАТЕЛНО

Риск от падащи части поради разхлабени винтове!
 Нараняване поради падащи части.
 ► Закрепете компонента, така че да не падне.



ВНИМАНИЕ!

Риск от падащи части поради разхлабени винтове!
Повреда на други части на уреда или в дома на клиента, напр. дъното.
▶ Закрепете компонента, така че да не падне.

Свалете винтовете отпред, като започнете отдолу нагоре (2, 3).

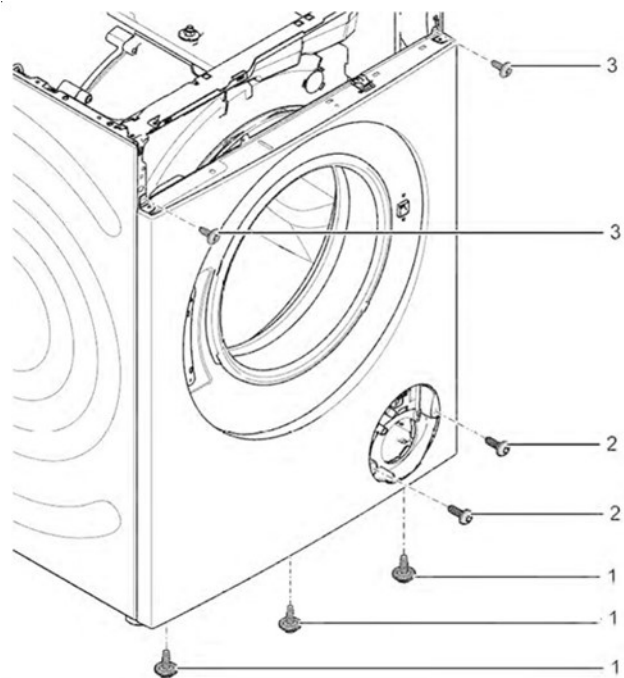





8. Свалете предния панел.

4.11.2 Монтиране на предния панел

▶ Монтирайте в обратен ред.

Savjeti za popravak - Perilica rublja

 O ovom dokumentu	25
1.1 Važne informacije	25
1.1.1 Svrha	25
1.2 Objasnjenje oznaka	25
1.2.1 Stupnjevi opasnosti	25
1.2.2 Oznake opasnosti	25
1.2.3 Struktura upozorenja	26
1.2.4 Opće oznake	26
 Sigurnost	27
2.1 Opće sigurnosne upute	27
2.1.1 Svi kućanski uređaji	27
 Alat i pomagala	28
 Popravak	29
4.1 Zamjena radne ploče	29
4.1.1 Uklanjanje radne ploče	29
4.1.2 Postavljanje radne ploče.....	29
4.2 Zamjena ploče.....	30
4.2.1 Uklanjanje ploče	30
4.2.2 Postavljanje ploče	30
4.3 Zamjena ladice za deterdžent.....	31
4.3.1 Uklanjanje ladice za deterdžent	31
4.3.2 Postavljanje ladice za deterdžent	31
4.4 Zamjena ručice ladice za deterdžent.....	32
4.4.1 Uklanjanje ručice ladice za deterdžent.....	32
4.4.2 Postavljanje ručice ladice za deterdžent	32
4.5 Zamjena vrata	33
4.5.1 Uklanjanje vrata	33
4.5.2 Postavljanje vrata.....	33
4.6 Zamjena sastavnih dijelova vrata.....	34
4.6.1 Uklanjanje sastavnih dijelova vrata.....	34
4.6.2 Postavljanje sastavnih dijelova vrata	34
4.7 Zamjena brtve vrata.....	35
4.7.1 Uklanjanje brtve vrata.....	35
4.7.2 Postavljanje brtve vrata	38

4.8 Zamjena brave vrata	39
4.8.1 Uklanjanje brave vrata	39
4.8.2 Postavljanje brave vrata	40
4.9 Zamjena svjetla bubnja.....	41
4.9.1 Uklanjanje svjetla bubnja	41
4.9.2 Postavljanje svjetla bubnja	41
4.10 Zamjena poklopca pumpe	42
4.10.1 Uklanjanje poklopca pumpe	42
4.10.2 Postavljanje poklopca pumpe	42
4.11 Zamjena prednje ploče	43
4.11.1 Uklanjanje prednje ploče	43
4.11.2 Postavljanje prednje ploče	45

i O ovom dokumentu

1.1 Važne informacije

1.1.1 Svrha

Ove upute za popravak služe kao podrška korisnicima prilikom samostalnog popravljivanja uređaja u skladu s primjenjivom Direktivom o ekološkom dizajnu (od ožujka 2021.).

One sadrže informacije o zamjeni određenih rezervnih dijelova, kao i napomene o upozorenjima i opasnostima.

Ako imate dodatna pitanja, obratite se našoj službi za korisnike. Mi snosimo odgovornost za oštećenja samo u slučaju pridržavanja uputa za popravak.

1.2 Objašnjenje oznaka

1.2.1 Stupnjevi opasnosti

Stupnjevi upozorenja sastoje se od oznake i signalne riječi. Signalna riječ ukazuje na ozbiljnost opasnosti.





Stupanj upozorenja	Značenje
 OPASNOST	Nepridržavanje poruke upozorenja rezultirat će smrtnim ili teškim ozljedama.
 UPOZORENJE	Nepridržavanje poruke upozorenja može rezultirati smrtnim ili teškim ozljedama.
 OPREZ	Nepridržavanje poruke upozorenja može rezultirati lakšim ozljedama.
 POZORI!	Nepridržavanje poruke upozorenja može rezultirati oštećenjem imovine.

Tablica 1: Stupnjevi opasnosti



1.2.2 Oznake opasnosti

Oznake opasnosti simbolička su reprezentacija s oznakom vrste opasnosti.

U ovom dokumentu koriste se sljedeće oznake opasnosti:

Oznaka opasnosti	Značenje
	Opća poruka upozorenja
	Opasnost od električnog napona
	Opasnost od eksplozije
	Opasnost od porezotina
	Opasnost od prignječenja

O ovom dokumentu

Oznaka opasnosti	Značenje
	Opasnost od vrućih površina
	Opasnost od jakog magnetskog polja
	Opasnost od neionizirajućeg zračenja

Tablica 2: Oznake opasnosti

1.2.3 Struktura upozorenja

Upozorenja u ovom dokumentu imaju normirani izgled i strukturu.



	<div style="background-color: red; color: white; padding: 2px; text-align: center;"> OPASNOST</div> <p>Vrsta i izvor opasnosti! Moguće posljedice zanemarivanja opasnosti/upozorenja.</p> <ul style="list-style-type: none"> ▶ Mjere i zabrane za sprječavanje opasnosti.
--	---





Sljedeći primjer pokazuje upozorenje na strujni udar od dijelova koji provode struju. Spominje se mjera za izbjegavanje opasnosti.

	<div style="background-color: red; color: white; padding: 2px; text-align: center;"> OPASNOST</div> <p>Opasnost od strujnog udara zbog dijelova koji provode struju! Smrt od strujnog udara</p> <ul style="list-style-type: none"> ▶ Isključite uređaj iz električnog napajanja najmanje 60 sekundi prije izvođenja popravaka.
---	--

1.2.4 Opće oznake

U ovom dokumentu koriste se sljedeće opće oznake:

Opća znaka	Značenje
	Oznaka posebnog savjeta (tekst i/ili grafika)
	Oznaka jednostavnog savjeta (samo tekst)
	Oznaka veze na videovodič

Opća znaka	Značenje
	Oznaka potrebnog alata
	Oznaka potrebnih preduvjeta
	Oznaka uvjeta (ako ..., tad ...)
	Oznaka rezultata
Početak	Oznaka tipke ili gumba
[00123456]	Oznaka broja materijala
Status	Oznaka prikazanog teksta / prozor (na zaslonu uređaja)

Tablica 3: Opće oznake

2.1 Opće sigurnosne upute

2.1.1 Svi kućanski uređaji

Opasnost od strujnog udara zbog dijelova koji provode struju!

- Pogreške izazvane popravcima električnih sastavnih dijelova mogu dovesti do strujnog udara!
- Isključite uređaj iz struje na najmanje 60 sekundi prije početka radova.
- Nakon popravka provedite sigurnosni test u skladu s VDE 0701 ili nacionalnim propisima.

Opasnost od ozljeda zbog oštih rubova!

- Nosite zaštitne rukavice.

Opasnost od prignječenja tijekom izvođenja radova na popravcima, održavanju, rješavanju problema i servisiranju teških i pokretnih sastavnih dijelova

- Nosite zaštitnu obuću.
- Osigurajte teške sastavne dijelove od pada.
- Nemojte umetati dijelove tijela u pokretne sastavne dijelove.







Opasnost za sigurnost/rad uređaja!

- Koristite samo originalne rezervne dijelove.

Opasnost od oštećenja elektrostatički osjetljivih sastavnih dijelova (ESD)!

- Nemojte dodirivati module, uključujući priključke i rute vodiča.

Alat i pomagala

Oznaka	Pojedinosti	Slike
Pomoćni alat [15000155]	Alat za otpuštanje plastičnih dijelova	
Odvijač Torx T20 s provrtom [00340764]	100 mm, za vijke sa sigurnosnim klinom	
Moment ključ [15000441]	Moment ključ 20 - 100 Nm	
Odvijač s utorom [00340854]	Nož 3,5 mm x 0,6 mm x 100 mm, zaštitna izolacija 1000 V AC	
Odvijač s utorom [00340855]	Nož 5,5 mm x 1,0 mm x 125 mm, zaštitna izolacija 1000 V AC	
Kliješta s iglenim nosom, kutni uzorak [00341269]	Duljina 200 mm	
Kliješta za bočno rezanje [00342182]	Duljina: 200 mm	



Oznaka	Pojedinosti	Slike
Kombinirani ključ [00340811]	Veličina ključa 10°mm, M6	
Combination wrench [00340814]	Veličina ključa 13°mm, M8	
Kombinirani ključ [00340817]	Veličina ključa 17 mm, M10	
Kombinirani ključ [15000459]	Veličina ključa 16°mm, M10	

4.1 Zamjena radne ploče

Specijalni alati:

-  Nastavak Torx TX20 s rupom, 6,3°mm (1/4") 152°mm, za vijke sa si- [00341272] gurnosnim klinom

Zahtjev:

-  Uređaj je isključen iz napajanja.
-  Uređaj je isključen iz priključka za dovod vode.

4.1.1 Uklanjanje radne ploče

- ▶ 1. Uklonite vijke (1).
- ▶ 2. Gurnite radnu ploču do stražnje strane uređaja (2).
- ▶ 3. Pomaknite radnu ploču prema gore (3) da biste je uklonili.

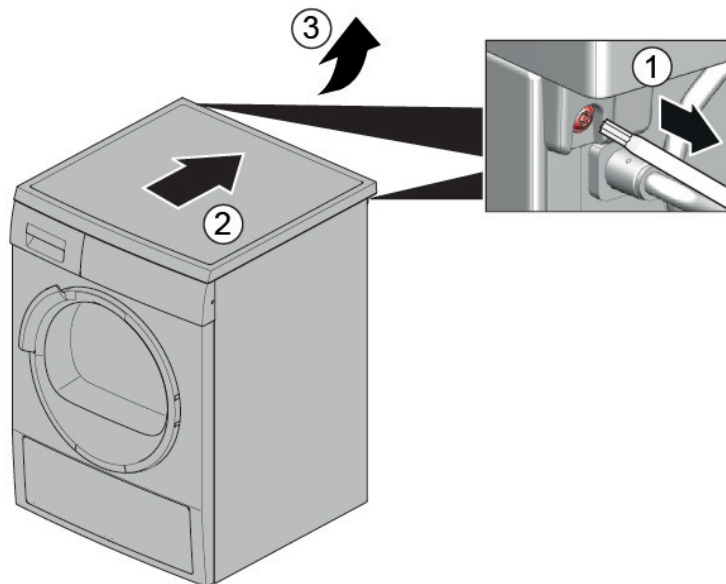

4.1.2 Postavljanje radne ploče

- ▶ Postavite obratnim redoslijedom.

4.2 Zamjena ploče



⚠️ OPREZ

Oštri rubovi kućišta!

Porezotine

- ▶ Nosite zaštitne rukavice.



⚠️ UPOZORENJE

Isklizavanje nagnutih uređaja!

Puknuća kostiju / ozljede od prignječenja

- ▶ Osigurajte uređaje od isklizavanja.



⚠️ OPREZ

Opasnost od padanja dijelova zbog otpuštenih vijaka!

Ozljeda od dijelova koji padaju.

- ▶ Osigurajte sastavne dijelove od pada.



POZOR!

Opasnost od padanja dijelova zbog otpuštenih vijaka!

Oštećenje drugih dijelova uređaja ili objekta klijenta, npr. poda.

- ▶ Osigurajte sastavne dijelove od pada.

Zahtjev:

- ✔ Uređaj je isključen iz napajanja.
- ✔ Uređaj je isključen iz priključka za dovod vode.
- ✔ [Radna je ploča uklonjena.→29](#)
- ✔ [Ladica za deterđent je uklonjena.→31](#)

4.2.1 Uklanjanje ploče

1. Uklonite vijke (1).
2. Otpustite zahvatne elemente (2, 3).

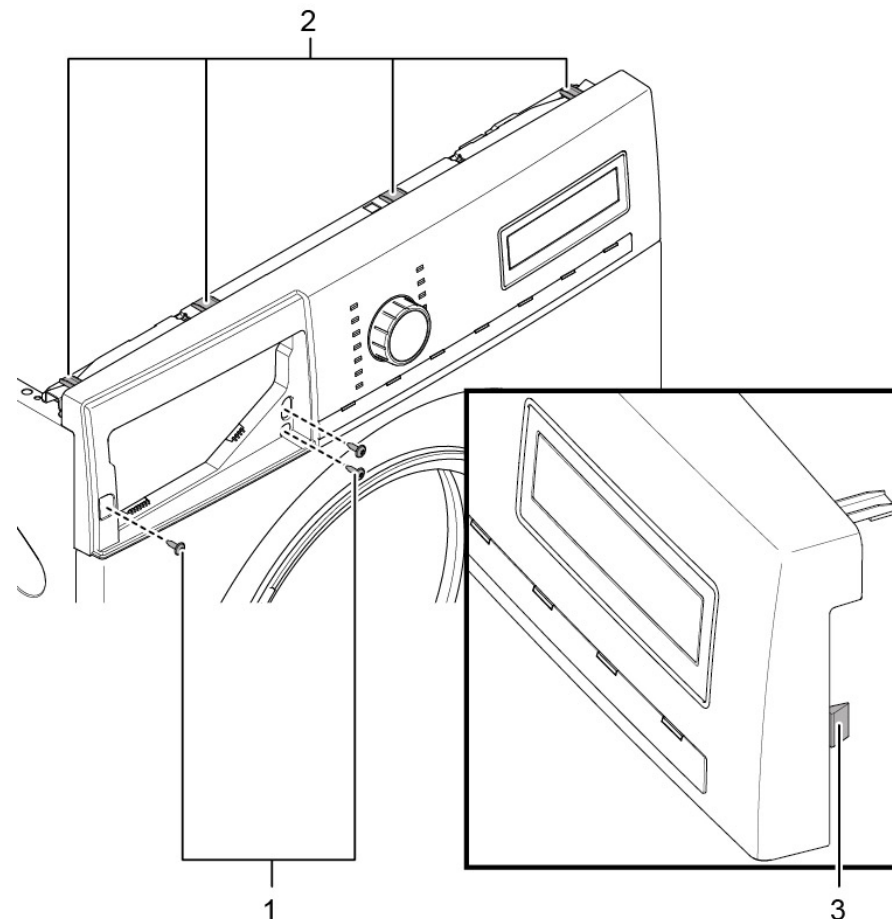

2. Otpustite priključni kontakt upravljačke jedinice.
3. Uklonite ploču.

4.2.2 Postavljanje ploče

- ▶ Postavite obratnim redoslijedom.

4.3 Zamjena ladice za deterdžent

Zahtjev:

- ✓ Uređaj je isključen iz napajanja.
- ✓ Uređaj je isključen iz priključka za dovod vode.

4.3.1 Uklanjanje ladice za deterdžent

1. Izvucite ladicu za deterdžent.
2. 1. Pritisnite uložak (1).
2. Uklonite ladicu za deterdžent (2).

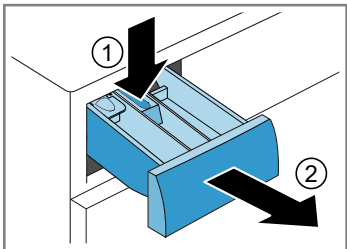

4.3.2 Postavljanje ladice za deterdžent

- ▶ Postavite obratnim redoslijedom.

4.4 Zamjena ručice ladice za deterdžent

Zahtjev:

- ✓ Uređaj je isključen iz napajanja.
- ✓ Uređaj je isključen iz priključka za dovod vode.
- ✓ [Ladica za deterdžent je uklonjena.→31](#)

4.4.1 Uklanjanje ručice ladice za deterdžent

1. Otpustite zahvatne elemente.

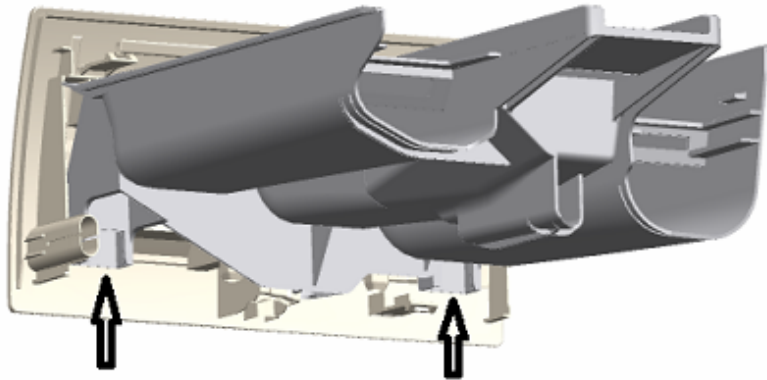

2. Uklonite ručicu ladice za deterdžent.

4.4.2 Postavljanje ručice ladice za deterdžent

- ▶ Postavite obratnim redoslijedom.

4.5 Zamjena vrata



⚠️ OPREZ

Otvorite područje zgloba!

Prignječenje/zaglavljivanje prstiju

- ▶ Nemojte posezati rukama u područje zgloba.
- ▶ Nosite zaštitne rukavice.

Zahtjev:

- ✔ Uređaj je isključen iz napajanja.
- ✔ Uređaj je isključen iz priključka za dovod vode.
- ✔ Vrata su otvorena.

4.5.1 Uklanjanje vrata

1.



POZOR!

Opasnost od padanja dijelova zbog otpuštenih vijaka!

Oštećenje drugih dijelova uređaja ili objekta klijenta, npr. poda.

- ▶ Osigurajte sastavne dijelove od pada.



⚠️ OPREZ

Opasnost od padanja dijelova zbog otpuštenih vijaka!

Ozljeda od dijelova koji padaju.

- ▶ Osigurajte sastavne dijelove od pada.

Uklonite vijke (1).

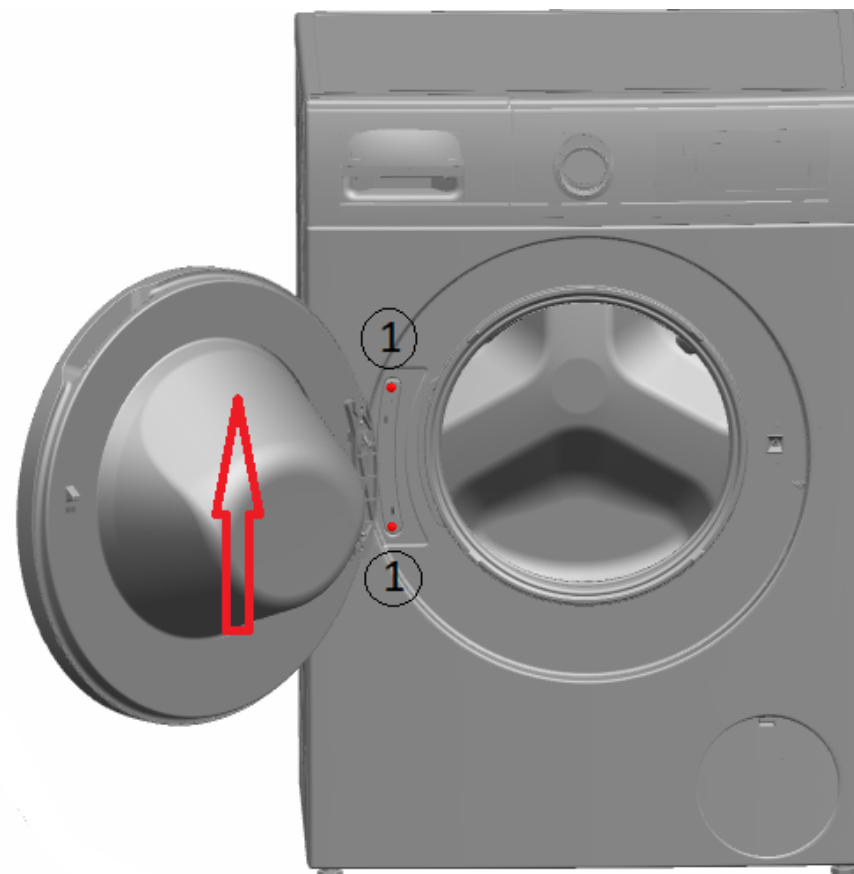

2. Uklonite vrata prema gore.

4.5.2 Postavljanje vrata

- ▶ Postavite obratnim redoslijedom.

4.6 Zamjena sastavnih dijelova vrata



OPREZ

Otvorite područje zgloba!

Prignječenje/zaglavljivanje prstiju

- ▶ Nemojte posezati rukama u područje zgloba.
- ▶ Nosite zaštitne rukavice.

Zahtjev:

- ✓ Uređaj je isključen iz napajanja.
- ✓ Uređaj je isključen iz priključka za dovod vode.
- ✓ [Vrata su uklonjena. →33](#)

4.6.1 Uklanjanje sastavnih dijelova vrata

- ▶ Rastavite vrata počevši s vanjske prema unutarnjoj strani.

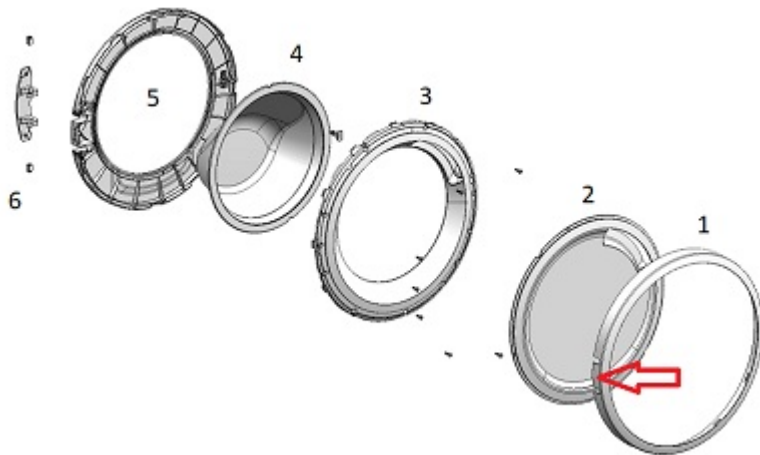

4.6.2 Postavljanje sastavnih dijelova vrata

- ▶ Postavite obratnim redoslijedom.

4.7 Zamjena brtve vrata



⚠️ OPREZ

Oštri rubovi kućišta!

Porezotine

- ▶ Nosite zaštitne rukavice.



⚠️ OPREZ

Opasnost od padanja dijelova zbog otpuštenih vijaka!

Ozljeda od dijelova koji padaju.

- ▶ Osigurajte sastavne dijelove od pada.



POZOR!

Opasnost od padanja dijelova zbog otpuštenih vijaka!

Oštećenje drugih dijelova uređaja ili objekta klijenta, npr. poda.

- ▶ Osigurajte sastavne dijelove od pada.

Zahtjev:

- ✓ Uređaj je isključen iz napajanja.
- ✓ Uređaj je isključen iz priključka za dovod vode.
- ✓ [Ladica za deterdžent je uklonjena.→31](#)
- ✓ [Vrata su uklonjena.→33](#)
- ✓ [Poklopac pumpe je uklonjen.→42](#)

4.7.1 Uklanjanje brtve vrata

1.



⚠️ UPOZORENJE

Isklizavanje nagnutih uređaja!

Puknuća kostiju / ozljede od prignječenja

- ▶ Osigurajte uređaje od isklizavanja.

Podignite uređaj s prednje strane.

2. Otpustite vijke donje strane prednje ploče (1).

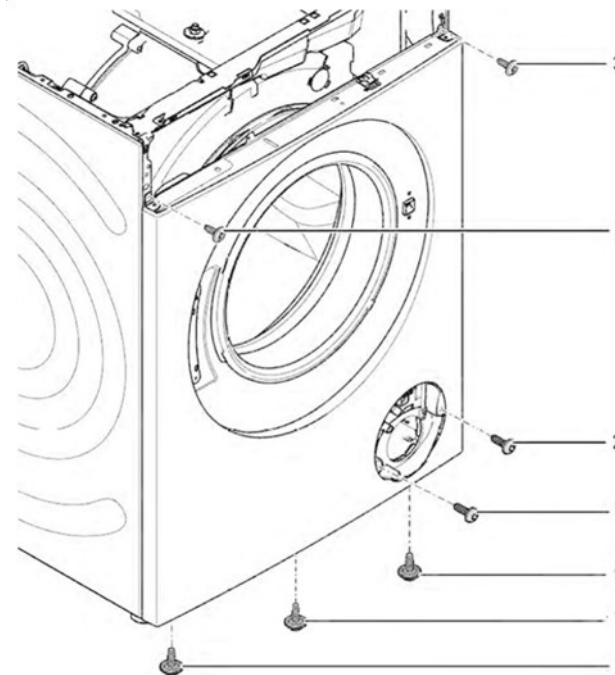

3. Spustite uređaj.

Popravak

4. Uklonite vijke u području pumpe (2).

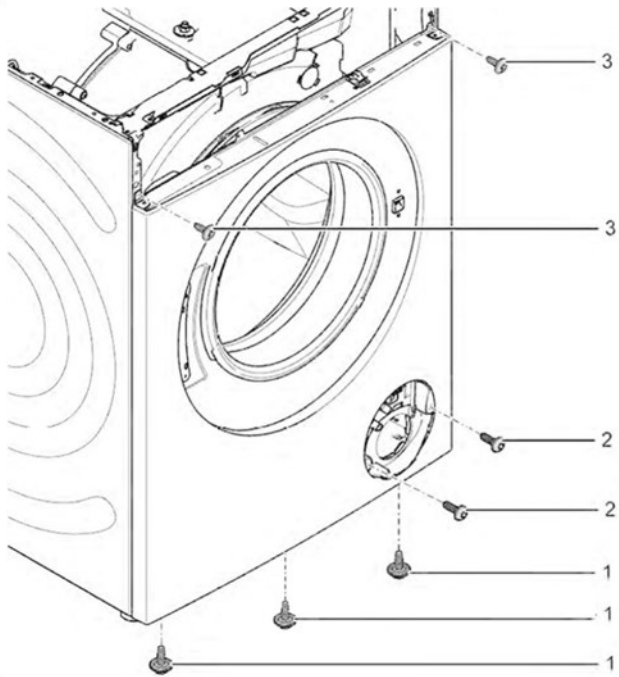

5. 1. Otpustite vijke na stražnjoj strani uređaja (1).
2. Uklonite radnu ploču (2, 3).

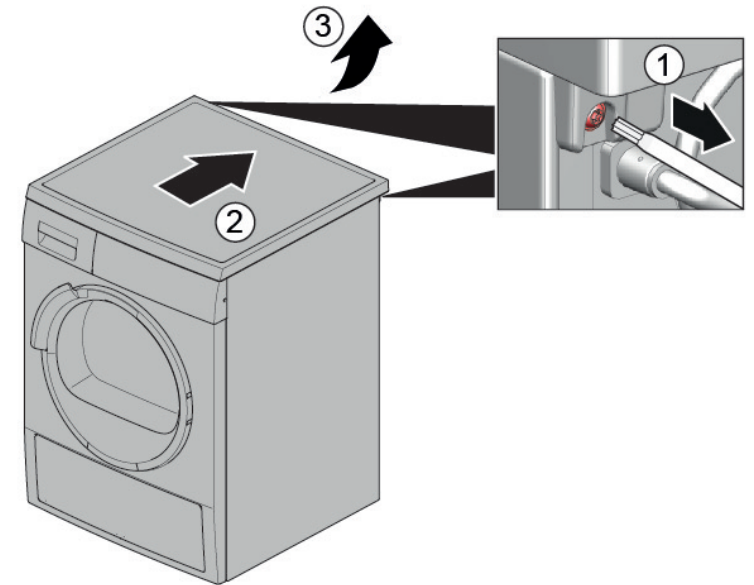

6. 1. Uklonite vijke (1).
2. Otpustite zahvatne elemente ploče (2, 3).
3. Otpustite vijke kućišta dozatora.

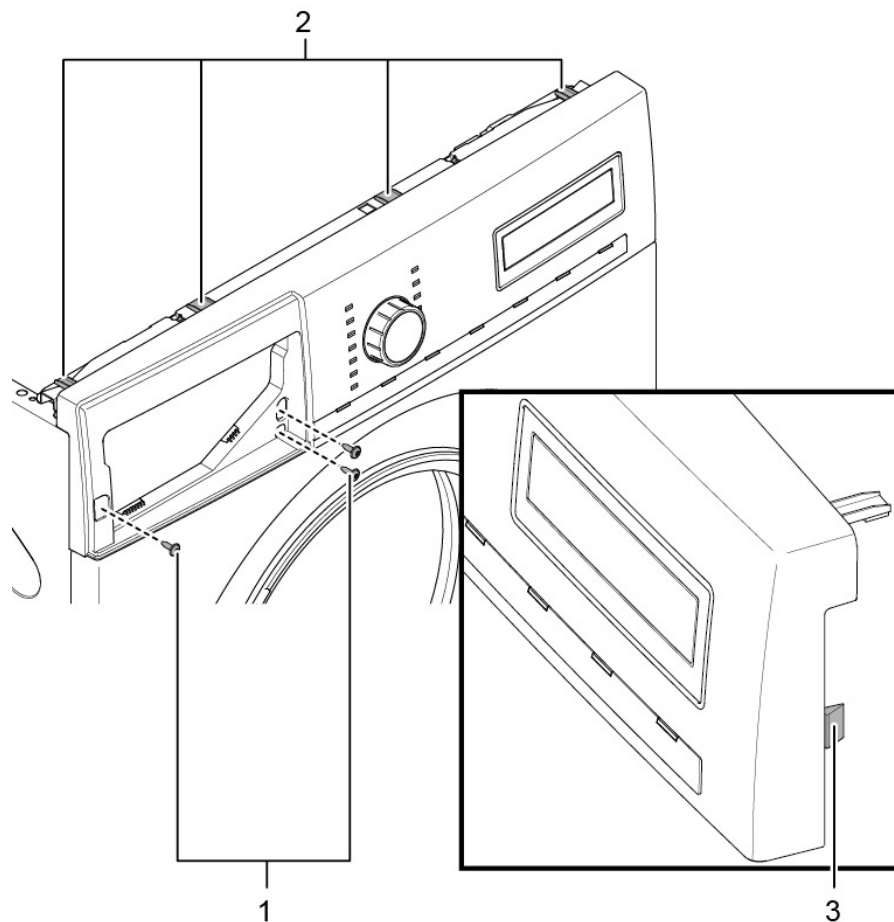

7. Uklonite ploču.

8. Uklonite držač svjetla bubnja na vrhu.

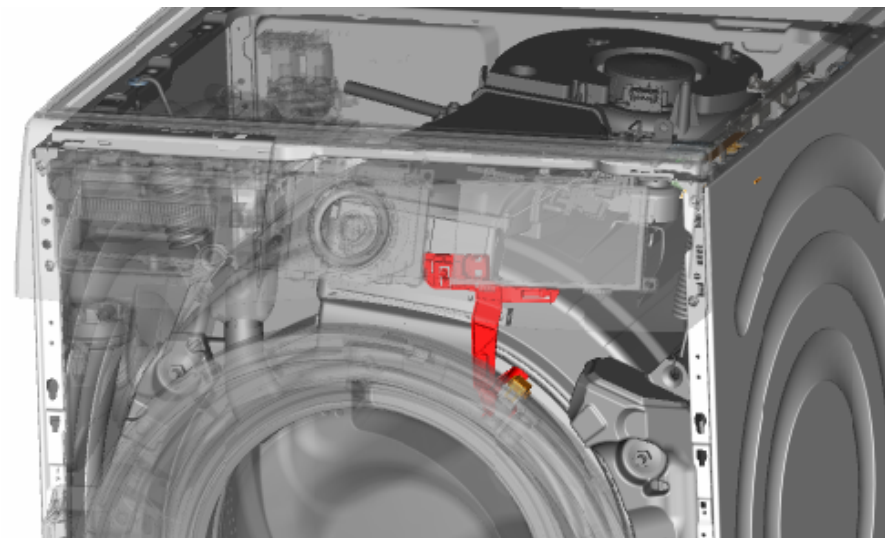

- 9.



POZOR!

Opasnost od oštećene površine!

Površina uređaja može se izgrebati upotrebom pogrešnog alata.
► Koristite samo plastični alat za zamjenu zateznog prstena.

Uklonite zatezni prsten s brtve s pomoću plastičnog alata.

10. Otpustite brtvu vrata s prednje ploče.
11. Otpustite priključak kabela s brave vrata.

12. Otpustite vijke s gornje strane prednje ploče (3).

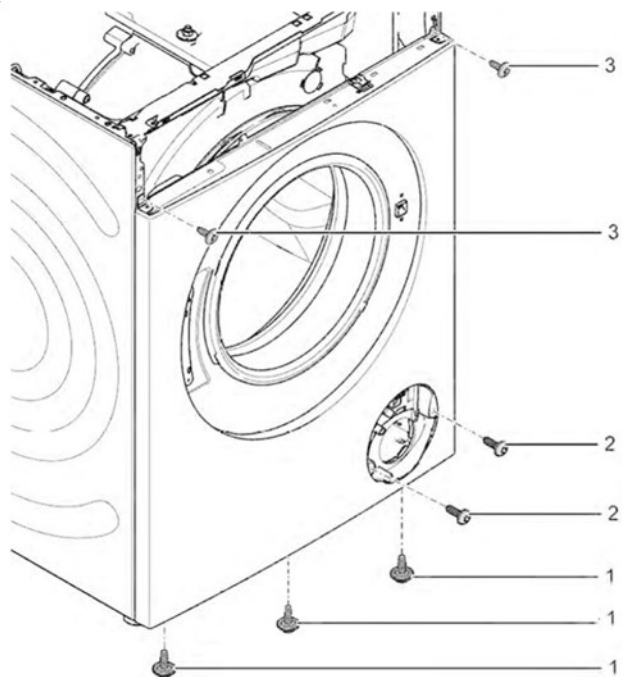

13. Uklonite prednju ploču.

14. Otpustite sve crijevne priključke.

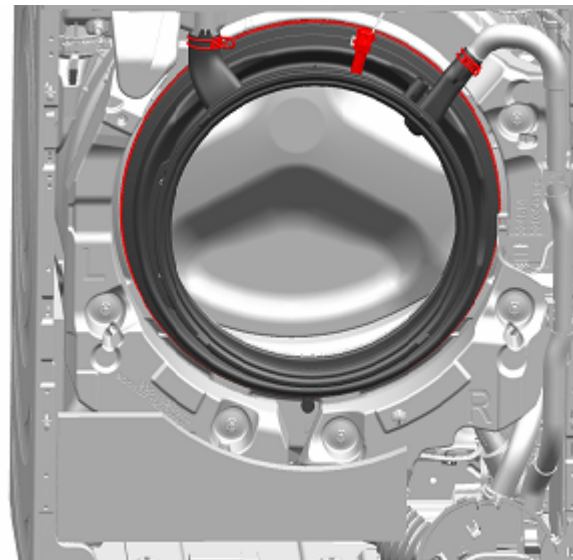

15. Uklonite brtvu vrata.

4.7.2 Postavljanje brtve vrata



⚠️ UPOZORENJE





Opasnost od padanja dijelova zbog neispravnog postavljanja!
Ozljede ili oštećenje uređaja.

▶ Pritegnite zatezni prsten brtve momentom od 3,4 Nm.

▶ Postavite obratnim redoslijedom.

4.8 Zamjena brave vrata

Kao proizvođač, obvezni smo pružiti potrošačima rezervne dijelove za bravu vrata, uključujući upute za popravak u skladu s Direktivom (EU) 2019/2023. Međutim, želimo naglasiti da nakon zamjene brave vrata kvalificirani elektrotehničar mora provesti elektrotehnički sigurnosni test prije puštanja uređaja u rad. Ta osoba mora biti potvrđeno kvalificirana u skladu s nacionalnim zakonima, propisima i normama.

	⚠️ OPASNOST Opasnost od strujnog udara zbog dijelova koji provode struju! U slučaju nepravilnog popravka može doći do opasnosti za život od strujnog udara <ul style="list-style-type: none">▶ Električne dijelove mora popraviti kvalificirani električar.▶ Nakon popravka provedite sigurnosni test u skladu s VDE 0701 ili nacionalnim propisima.
	⚠️ OPREZ Oštri rubovi kućišta! Porezotine <ul style="list-style-type: none">▶ Nosite zaštitne rukavice.
	⚠️ UPOZORENJE Isklizavanje nagnutih uređaja! Puknuća kostiju / ozljede od prignječenja <ul style="list-style-type: none">▶ Osigurajte uređaje od isklizavanja.
	⚠️ OPREZ Opasnost od padanja dijelova zbog otpuštenih vijaka! Ozljeda od dijelova koji padaju. <ul style="list-style-type: none">▶ Osigurajte sastavne dijelove od pada.
	⚠️ POZOR! Opasnost od padanja dijelova zbog otpuštenih vijaka! Oštećenje drugih dijelova uređaja ili objekta klijenta, npr. poda. <ul style="list-style-type: none">▶ Osigurajte sastavne dijelove od pada.

Zahtjev:

- ✔ Uređaj je isključen iz napajanja.
- ✔ Uređaj je isključen iz priključka za dovod vode.

- ✔ Uređaju se može slobodno pristupiti.
- ✔ [Radna je ploča uklonjena. →29](#)
- ✔ Ploča je uklonjena.
- ✔ [Vrata su uklonjena. →33](#)
- ✔ Zatezni prsten je uklonjen.
- ✔ Prednja ploča je uklonjena.
- ✔ Brtva vrata je uklonjena.

4.8.1 Uklanjanje brave vrata

1. Iskopčajte priključak brave vrata.
2. Otpustite bravu vrata.



3. Uklonite bravu vrata.

4.8.2 Postavljanje brave vrata

Brava vrata mora biti u odgovarajućem položaju kako bi se osigurala funkcija otvaranja vrata uređaja za slučaj nužde.



- ▶ Postavite obratnim redoslijedom.

4.9 Zamjena svjetla bubnja



⚠️ OPREZ

Oštri rubovi kućišta!

Porezotine

- ▶ Nosite zaštitne rukavice.



⚠️ UPOZORENJE

Isklizavanje nagnutih uređaja!

Puknuća kostiju / ozljede od prignječenja

- ▶ Osigurajte uređaje od isklizavanja.



⚠️ OPREZ

Opasnost od padanja dijelova zbog otpuštenih vijaka!

Ozljeda od dijelova koji padaju.

- ▶ Osigurajte sastavne dijelove od pada.



POZOR!

Opasnost od padanja dijelova zbog otpuštenih vijaka!

Oštećenje drugih dijelova uređaja ili objekta klijenta, npr. poda.

- ▶ Osigurajte sastavne dijelove od pada.

Zahtjev:

- ✔ Uređaj je isključen iz napajanja.
- ✔ Uređaj je isključen iz priključka za dovod vode.
- ✔ Uređaju se može slobodno pristupiti.
- ✔ [Radna je ploča uklonjena.→29](#)
- ✔ [Ladica za deterđent je uklonjena.→31](#)
- ✔ Ploča je uklonjena.

4.9.1 Uklanjanje svjetla bubnja

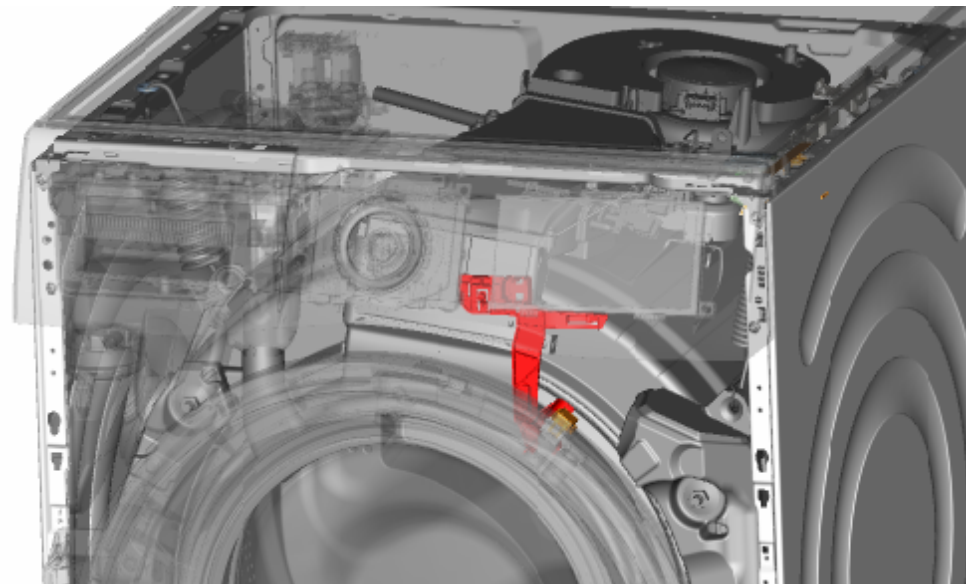

1. Izvucite držač svjetla bubnja iz uređaja.
2. Odvojite električne priključke.
3. Uklonite svjetlo bubnja s držača svjetla bubnja.

4.9.2 Postavljanje svjetla bubnja

- ▶ Postavite obratnim redoslijedom.

4.10 Zamjena poklopca pumpe

Zahtjev:

- ✓ Uređaj je isključen iz napajanja.
- ✓ Uređaj je isključen iz priključka za dovod vode.

4.10.1 Uklanjanje poklopca pumpe

1. Otvorite poklopac pumpe.

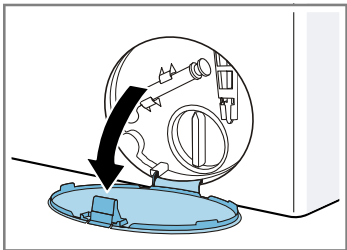

2. Uklonite poklopac pumpe.

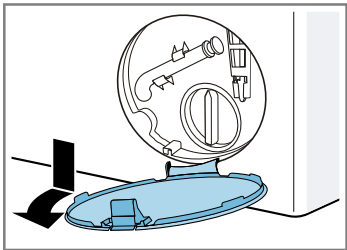

4.10.2 Postavljanje poklopca pumpe

- ▶ Postavite obratnim redoslijedom.

4.11 Zamjena prednje ploče



⚠️ OPREZ

Oštri rubovi kućišta!

Porezotine

- ▶ Nosite zaštitne rukavice.

Zahtjev:

- ✓ Uređaj je isključen iz napajanja.
- ✓ Uređaj je isključen iz priključka za dovod vode.
- ✓ [Ladica za deterdžent je uklonjena.→31](#)
- ✓ [Vrata su uklonjena.→33](#)
- ✓ Brtva vrata je uklonjena.
- ✓ [Poklopac pumpe je uklonjen.→42](#)

4.11.1 Uklanjanje prednje ploče

1.



⚠️ UPOZORENJE

Isklizavanje nagnutih uređaja!

Puknuća kostiju / ozljede od prignječenja

- ▶ Osigurajte uređaje od isklizavanja.

Podignite uređaj s prednje strane.

2. Uklonite vijke s donje strane (1).

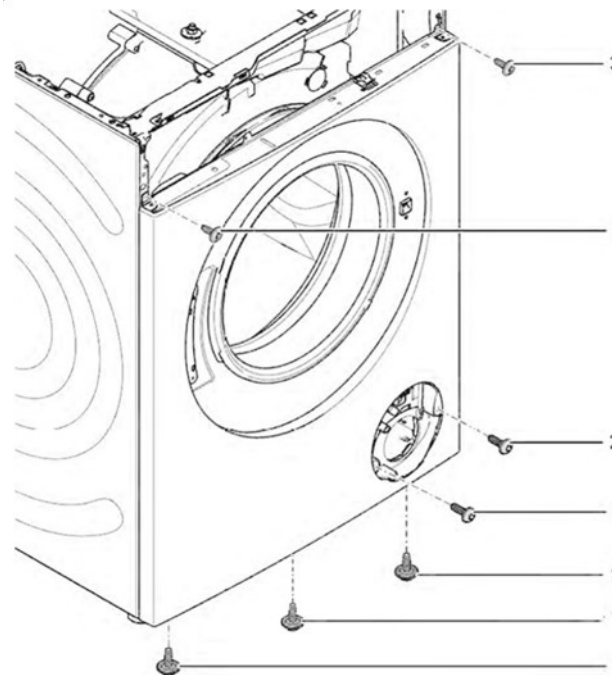

3. Spustite uređaj.

Popravak

4. 1. Uklonite vijke (1).
2. Gurnite radnu ploču do stražnje strane uređaja (2).
3. Pomaknite radnu ploču prema gore (3) da biste je uklonili.

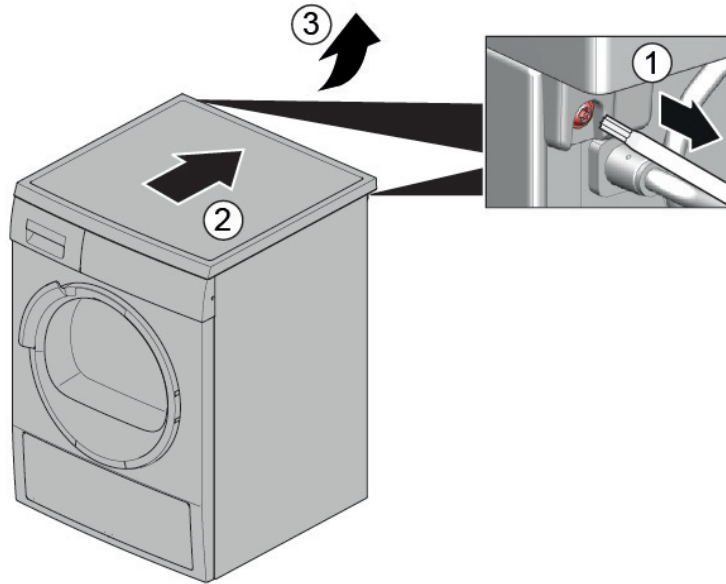

5. 1. Uklonite vijke (1).
2. Otpustite zahvatne elemente (2, 3).

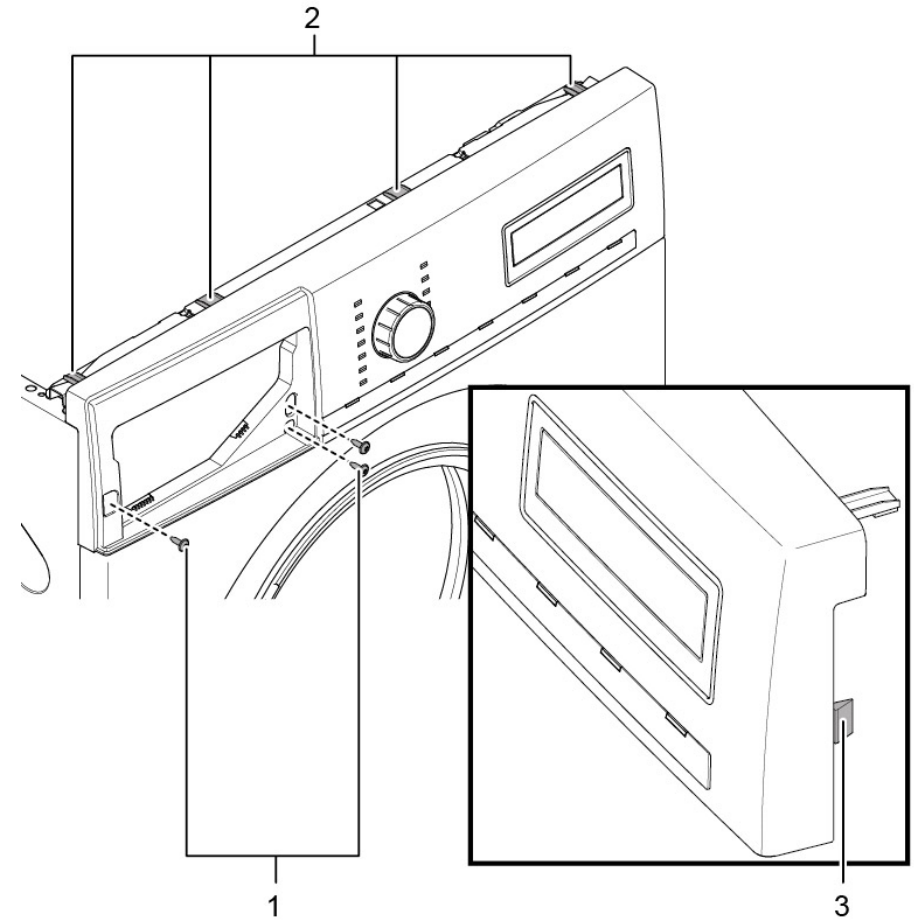

6. Uklonite ploču.

7.



OPREZ

Opasnost od padanja dijelova zbog otpuštenih vijaka!

Ozljeda od dijelova koji padaju.

- ▶ Osigurajte sastavne dijelove od pada.



POZOR!

Opasnost od padanja dijelova zbog otpuštenih vijaka!
Oštećenje drugih dijelova uređaja ili objekta klijenta, npr. poda.
▶ Osigurajte sastavne dijelove od pada.

Uklonite vijke s prednje strane, počevši od dna prema gore (2, 3).

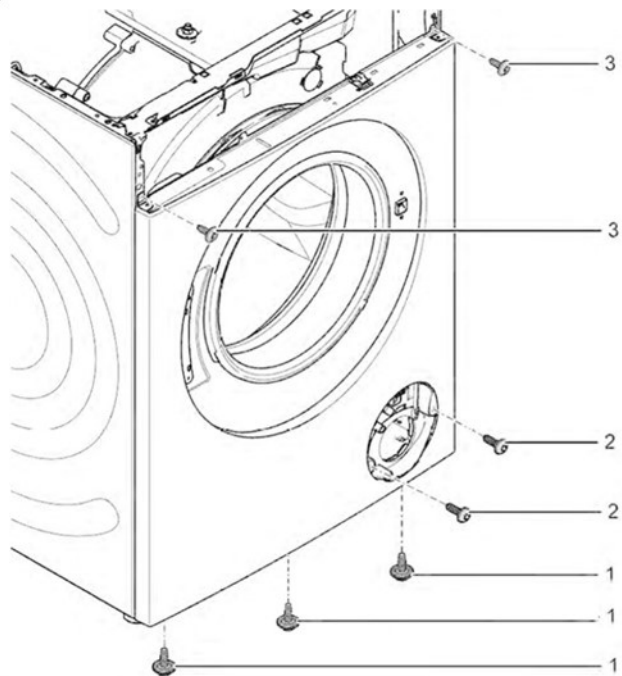





8. Uklonite prednju ploču.

4.11.2 Postavljanje prednje ploče

▶ Postavite obratnim redoslijedom.

Poznámky k opravě - Pračka

 O tomto dokumentu	47		
1.1 Důležité informace	47		
1.1.1 Účel	47		
1.2 Vysvětlení symbolů	47		
1.2.1 Úroveň nebezpečí	47		
1.2.2 Symboly nebezpečí	47		
1.2.3 Struktura výstrah	48		
1.2.4 Obecné symboly	48		
 Bezpečnost	49		
2.1 Všeobecné bezpečnostní pokyny	49		
2.1.1 Všechny domácí spotřebiče	49		
 Nástroje a pomůcky	50		
 Oprava	51		
4.1 Výměna pracovní desky	51		
4.1.1 Sejmutí pracovní desky	51		
4.1.2 Montáž pracovní desky	51		
4.2 Výměna panelu obložení	52		
4.2.1 Sejmutí panelu obložení	52		
4.2.2 Montáž panelu obložení	52		
4.3 Výměna zásuvky na prací prostředek	53		
4.3.1 Vyjmutí zásuvky na prací prostředek	53		
4.3.2 Montáž zásuvky na prací prostředek	53		
4.4 Výměna madla zásuvky na prací prostředek	54		
4.4.1 Odstranění madla zásuvky na prací prostředek	54		
4.4.2 Montáž madla zásuvky na prací prostředek	54		
4.5 Výměna dvířek	55		
4.5.1 Vyjmutí dvířek	55		
4.5.2 Montáž dvířek	55		
4.6 Výměna součástí dvířek	56		
4.6.1 Odstranění součástí dvířek	56		
4.6.2 Montáž součástí dvířek	56		
4.7 Výměna těsnění dvířek	57		
4.7.1 Vyjmutí těsnění dvířek	57		
4.7.2 Montáž těsnění dvířek	60		
4.8 Výměna pojistky dvířek	61		
4.8.1 Odstranění pojistky dvířek	61		
4.8.2 Montáž pojistky dvířek	62		
4.9 Výměna osvětlení bubny	63		
4.9.1 Odstranění osvětlení bubny	63		
4.9.2 Montáž osvětlení bubny	63		
4.10 Výměna krytu čerpadla	64		
4.10.1 Odstranění krytu čerpadla	64		
4.10.2 Montáž krytu čerpadla	64		
4.11 Výměna předního panelu	65		
4.11.1 Sejmutí předního panelu	65		
4.11.2 Montáž předního panelu	67		

i O tomto dokumentu

1.1 Důležité informace

1.1.1 Účel

Tyto pokyny k opravě pomáhají spotřebiteli při vlastnoruční opravě spotřebičů v souladu s platnými předpisy o ekodesignu (platnými k 03/2021).



Obsahují informace o výměně některých náhradních dílů včetně příslušných výstrah a nebezpečí.

V případě dotazů se obraťte na náš zákaznický servis. Za škody ručíme pouze v případě, že budou správně dodrženy pokyny k opravě.

1.2 Vysvětlení symbolů

1.2.1 Úroveň nebezpečí

Jednotlivé úrovně výstrah se skládají ze symbolu a signálního slova. Signální slova uvádějí závažnost nebezpečí.





Úroveň výstrahy	Význam
 NEBEZPEČÍ	Nedodržení výstražného upozornění způsobí smrt nebo vážná zranění.
 VÝSTRAHA	Nedodržení výstražného upozornění může způsobit smrt nebo vážná zranění.
 POZOR	Nedodržení výstražného upozornění může způsobit lehká zranění.
POZOR!	Nedodržení výstražného upozornění může způsobit škody na majetku.

Tabulka 1: Úroveň nebezpečí



1.2.2 Symboly nebezpečí

Symboly nebezpečí jsou symbolická znázornění určující druh nebezpečí.

V tomto dokumentu jsou použity následující symboly nebezpečí:

Symbol nebezpečí	Význam
	Obecné výstražné upozornění
	Nebezpečí vycházející z elektrického napětí
	Nebezpečí výbuchu
	Nebezpečí pořezání
	Nebezpečí rozdrcení



O tomto dokumentu

Symbol nebezpečí	Význam
	Nebezpečí spojené s horkými povrchy
	Nebezpečí vycházející ze silného elektromagnetického pole
	Nebezpečí z neionizujícího záření

Tabulka 2: Symboly nebezpečí

1.2.3 Struktura výstrah

Výstrahy použité v tomto dokumentu mají standardizovaný vzhled a strukturu.



	<div style="background-color: red; color: white; padding: 2px; text-align: center;"> NEBEZPEČÍ</div> <p>Typ a zdroj nebezpečí! Možné důsledky nedodržení výstražného upozornění.</p> <ul style="list-style-type: none"> ▶ Opatření a zákazy eliminující nebezpečí.
--	--





Následující příklad ukazuje výstrahu, která varuje před zásahem elektrickým proudem při dotyku dílů pod proudem. Je uvedeno opatření pro zabránění rizika.

	<div style="background-color: red; color: white; padding: 2px; text-align: center;"> NEBEZPEČÍ</div> <p>Nebezpečí úrazu elektrickým proudem při dotyku dílů pod proudem! Usmrcení elektrickým proudem</p> <ul style="list-style-type: none"> ▶ Odpojte spotřebič od přívodu elektrického proudu alespoň 60 sekund před zahájením opravy.
---	--

1.2.4 Obecné symboly

V tomto dokumentu jsou použity následující obecné symboly:

Obecný symbol	Význam
	Uvedení zvláštního tipu (text nebo grafické vyjádření)
	Uvedení jednoduchého tipu (pouze text)
	Uvedení odkazu k videonávodu

Obecný symbol	Význam
	Uvedení požadovaných nástrojů
	Uvedení požadovaných podmínek
	Uvedení podmínky (když, pak atd.)
	Uvedení výsledku
[Start]	Uvedení klávesy nebo tlačítka
[00123456]	Uvedení čísla materiálu
Status	Uvedení zobrazeného textu / okna (na ukazateli spotřebiče)

Tabulka 3: Obecné symboly

2.1 Všeobecné bezpečnostní pokyny

2.1.1 Všechny domácí spotřebiče

Nebezpečí úrazu elektrickým proudem při dotyku dílů pod proudem!

- Chyby při opravě elektrických součástí mohou vést k úrazu elektrickým proudem!
- Odpojte spotřebič ze sítě alespoň 60 sekund před zahájením prací.
- Po opravě nechte provést bezpečnostní zkoušku podle VDE 0701 nebo specifických předpisů dané země.

Nebezpečí poranění o ostré hrany!

- Používejte ochranné rukavice.

Nebezpečí rozdrčení během opravy, údržby, odstranění závad a servisu těžkými a pohyblivými součástmi

- Používejte bezpečnostní obuv.
- Zajistěte těžké součásti před pádem.
- Nesahejte na pohyblivé součásti.







Nebezpečí z hlediska bezpečnosti / funkce spotřebiče!





- Používejte pouze originální náhradní díly.

Nebezpečí poškození elektrostaticky citlivých součástí (elektrostatický výboj)!

- Nedotýkejte se modulů, včetně přípojek a vodičů.

Nástroje a pomůcky

Označení	Detaily	Snímky
Pomocný nástroj [15000155]	Nástroj pro uvolnění plastových dílů	
Šroubovák torx T20 s otvorem [00340764]	100 mm, pro šrouby s pojistným kolíkem	
Momentový klíč [15000441]	Momentový klíč 20–100 Nm	
Plochý šroubovák [00340854]	Čepel 3,5 mm x 0,6 mm x 100 mm, ochranná izolace 1000 V AC	
Plochý šroubovák [00340855]	Čepel 5,5 mm x 1,0 mm x 125 mm, ochranná izolace 1 000 V AC	
Jehlové kleště, zahnuté [00341269]	Délka 200 mm	
Boční štípací kleště [00342182]	Délka: 200 mm	



Označení	Detaily	Snímky
Maticový klíč [00340811]	Velikost klíče 10°mm, M6	
Combination wrench [00340814]	Velikost klíče 13°mm, M8	
Maticový klíč [00340817]	Velikost klíče 17 mm, M10	
Maticový klíč [15000459]	Velikost klíče 16°mm, M10	

4.1 Výměna pracovní desky

Speciální nástroje:

-  Bit torx TX20 s otvorem, dlouhý 6,3°mm (1/4") 152°mm, pro šrouby s pojistným kolíkem [00341272]

Požadavek:

-  Spotřebič je odpojený od přívodu elektrické energie.
-  Spotřebič je odpojený od přívodu vody.

4.1.1 Sejmutí pracovní desky

- ▶ 1. Odstraňte šrouby (1).
- ▶ 2. Posuňte pracovní desku do zadní části spotřebiče (2).
- ▶ 3. Zvedněte pracovní desku nahoru (3) a sejměte ji.

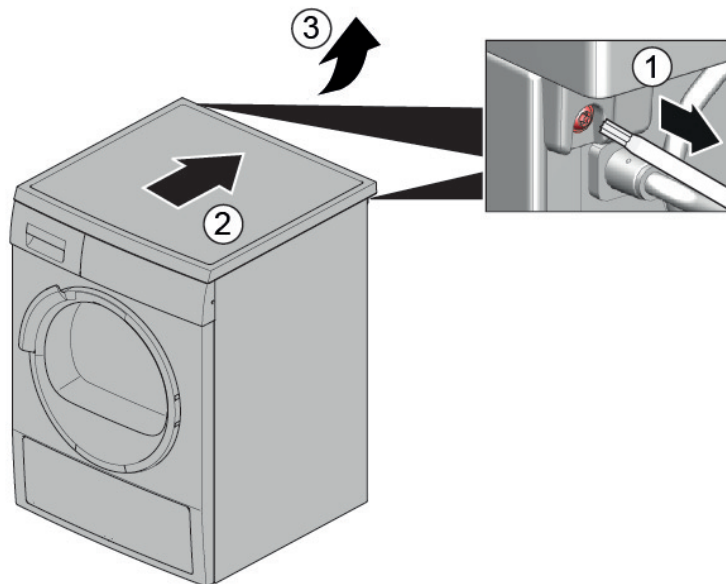

4.1.2 Montáž pracovní desky

- ▶ Montáž proveďte v opačném sledu.

4.2 Výměna panelu obložení



POZOR

Ostré hrany skříně!
Nebezpečí řezných poranění
▶ Používejte ochranné rukavice.



VÝSTRAHA

Sklouznutí nakloněných spotřebičů!
Zlomeniny / poranění rozdrcením
▶ Zajistěte spotřebiče proti sklouznutí.



POZOR





Nebezpečí padajících dílů kvůli uvolněným šroubům!
Poranění padajícími díly.
▶ Zajistěte jednotlivé součásti před pádem.



POZOR!

Nebezpečí padajících dílů kvůli uvolněným šroubům!
Poškození jiných částí spotřebiče nebo prvků domácnosti zákazníka, např. podlahy.
▶ Zajistěte jednotlivé součásti před pádem.

Požadavek:

-  Spotřebič je odpojený od přívodu elektrické energie.
-  Spotřebič je odpojený od přívodu vody.
-  [Pracovní deska je sejmutá.→51](#)
-  [Zásuvka na práci prostředek je vyjmutá.→53](#)

4.2.1 Sejmutí panelu obložení

1. 1. Odstraňte šrouby (1).
2. 2. Uvolněte západky (2, 3).

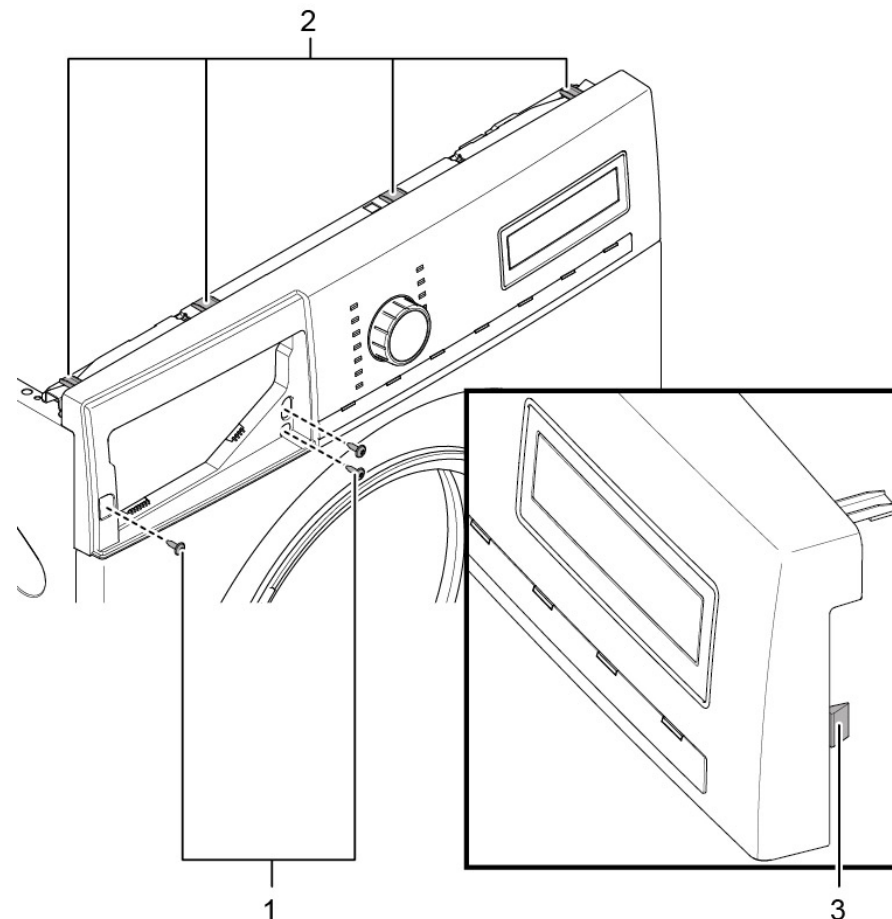

2. Vytáhněte zástrčku řídicí jednotky.
3. Sejměte panel obložení.

4.2.2 Montáž panelu obložení

- ▶ Montáž provedte v opačném sledu.

4.3 Výměna zásuvky na prací prostředek

Požadavek:

- ✔ Spotřebič je odpojený od přívodu elektrické energie.
- ✔ Spotřebič je odpojený od přívodu vody.

4.3.1 Vyjmutí zásuvky na prací prostředek

1. Vytáhněte zásuvku na prací prostředek.
2. 1. Zatlačte na vložku (1).
2. Vyměňte zásuvku na prací prostředek (2).

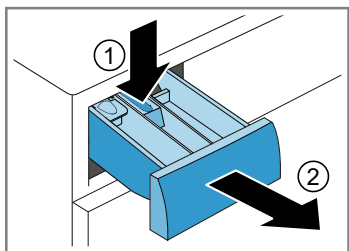

4.3.2 Montáž zásuvky na prací prostředek

- ▶ Montáž provedte v opačném sledu.

4.4 Výměna madla zásuvky na prací prostředek

Požadavek:

- ✔ Spotřebič je odpojený od přívodu elektrické energie.
- ✔ Spotřebič je odpojený od přívodu vody.
- ✔ [Zásuvka na prací prostředek je vyjmutá.→53](#)

4.4.1 Odstranění madla zásuvky na prací prostředek

1. Uvolněte západky.

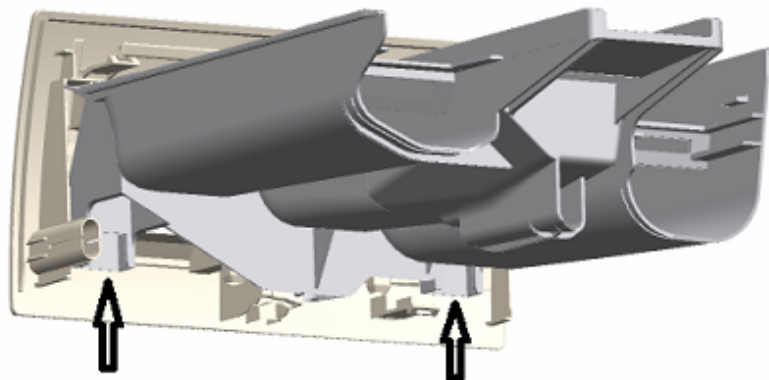

2. Odstraňte madlo zásuvky na prací prostředek.

4.4.2 Montáž madla zásuvky na prací prostředek

- ▶ Montáž provedte v opačném sledu.

4.5 Výměna dvířek



⚠ POZOR

Otevřete prostor se závěsy!

Rozdrcení prstů / zachycení

- ▶ Nesahejte do prostoru se závěsy.
- ▶ Používejte ochranné rukavice.

Požadavek:

- ✔ Spotřebič je odpojený od přívodu elektrické energie.
- ✔ Spotřebič je odpojený od přívodu vody.
- ✔ Dvířka jsou otevřená.

4.5.1 Vyjmutí dvířek

1.



POZOR!

Nebezpečí padajících dílů kvůli uvolněným šroubům!

Poškození jiných částí spotřebiče nebo prvků domácnosti zákazníka, např. podlahy.

- ▶ Zajistěte jednotlivé součásti před pádem.



⚠ POZOR

Nebezpečí padajících dílů kvůli uvolněným šroubům!

Poranění padajícími díly.

- ▶ Zajistěte jednotlivé součásti před pádem.

Odstraňte šrouby (1).

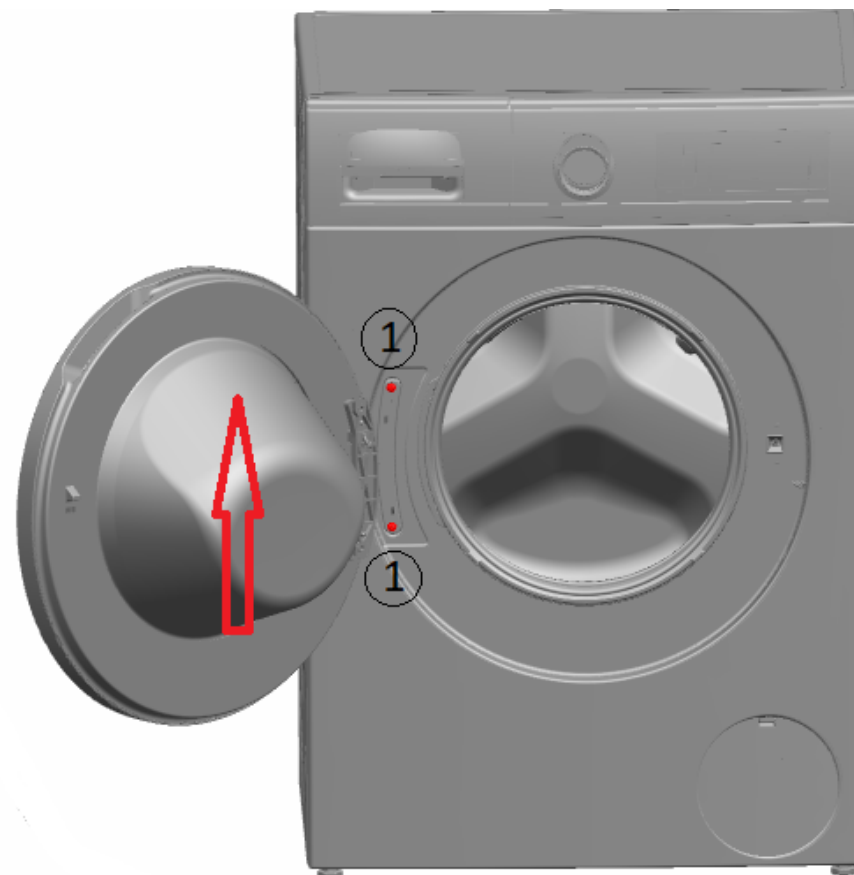

2. Vyjměte dvířka směrem nahoru.

4.5.2 Montáž dvířek

- ▶ Montáž proveďte v opačném sledu.

4.6 Výměna součástí dvířek



POZOR

Otevřete prostor se závěsy!

Rozdrcení prstů / zachycení

- ▶ Nesahejte do prostoru se závěsy.
- ▶ Používejte ochranné rukavice.

Požadavek:

- ✔ Spotřebič je odpojený od přívodu elektrické energie.
- ✔ Spotřebič je odpojený od přívodu vody.
- ✔ [Dvířka jsou odstraněná. → 55](#)

4.6.1 Odstranění součástí dvířek

- ▶ Demontujte dvířka zvenku dovnitř.

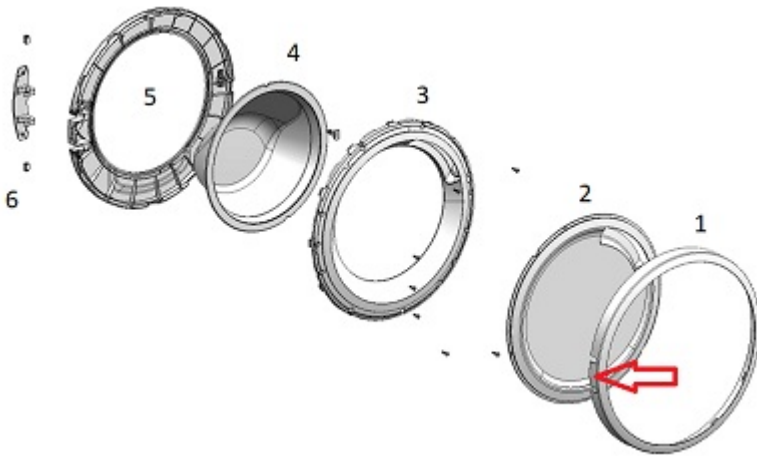

4.6.2 Montáž součástí dvířek

- ▶ Montáž proveďte v opačném sledu.

4.7 Výměna těsnění dvířek



POZOR

Ostré hrany skříně!
Nebezpečí řezných poranění
▶ Používejte ochranné rukavice.



POZOR

Nebezpečí padajících dílů kvůli uvolněným šroubům!
Poranění padajícími díly.
▶ Zajistěte jednotlivé součásti před pádem.



POZOR!

Nebezpečí padajících dílů kvůli uvolněným šroubům!
Poškození jiných částí spotřebiče nebo prvků domácnosti zákazníka, např. podlahy.
▶ Zajistěte jednotlivé součásti před pádem.

Požadavek:

- ✔ Spotřebič je odpojený od přívodu elektrické energie.
- ✔ Spotřebič je odpojený od přívodu vody.
- ✔ [Zásuvka na prací prostředek je vyjmutá.→53](#)
- ✔ [Dvířka jsou odstraněná.→55](#)
- ✔ [Kryt čerpadla je odstraněný.→64](#)

4.7.1 Vyjmutí těsnění dvířek

1.



VÝSTRAHA

Sklouznutí nakloněných spotřebičů!
Zlomeniny / poranění rozdrcením
▶ Zajistěte spotřebiče proti sklouznutí.

Zvedněte přední část spotřebiče.

2. Uvolněte šrouby na spodní straně předního panelu (1).

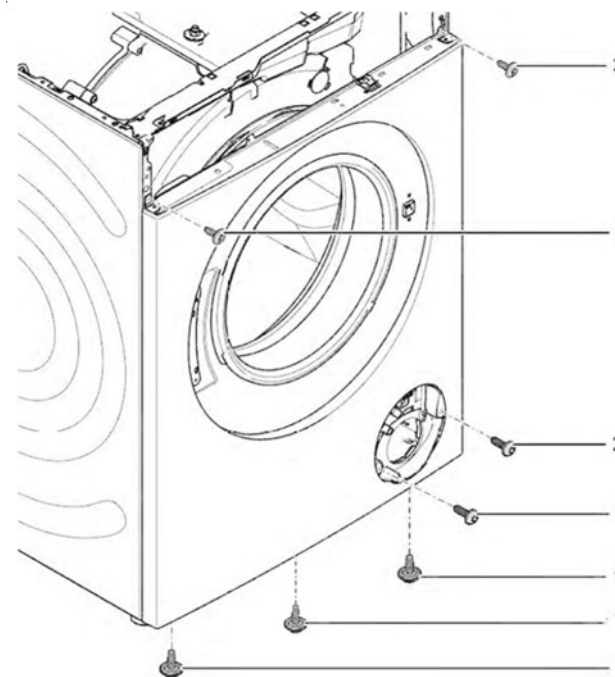

3. Položte spotřebič.

4. Odstraňte šrouby z oblasti čerpadla (2).

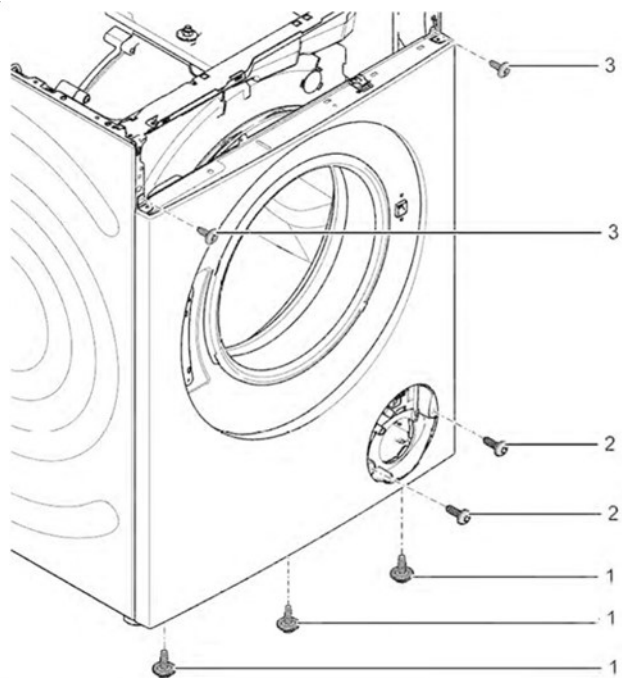

5. 1. Odstraňte šrouby ze zadní strany spotřebiče (1).
2. Sejměte pracovní desku (2, 3).

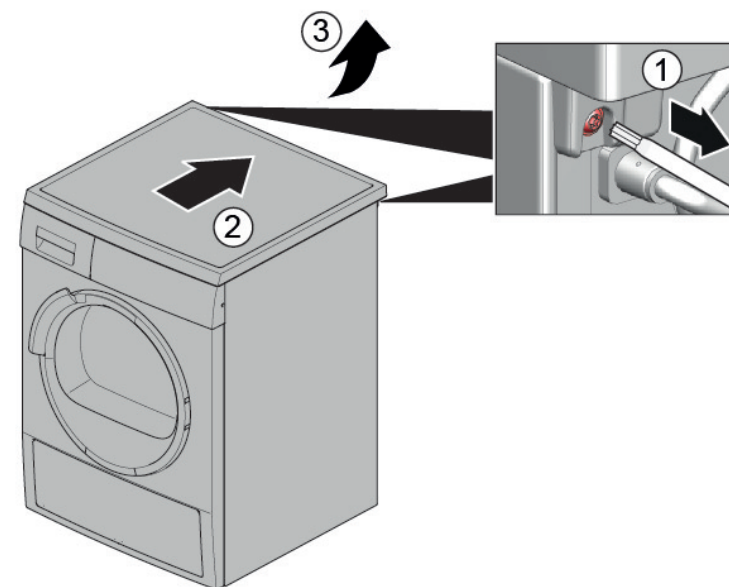

6. 1. Odstraňte šrouby (1).
2. Uvolněte západky panelu obložení (2, 3).
3. Uvolněte šrouby skříně dávkovací jednotky.

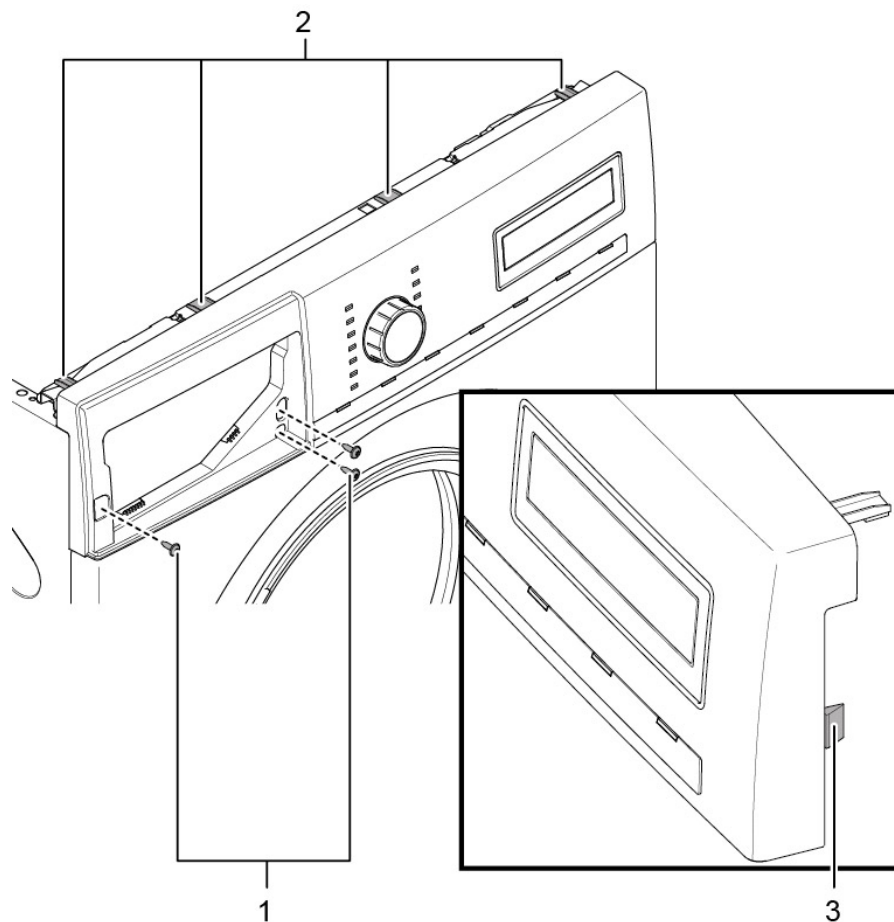

7. Sejměte panel obložení.

8. Sejměte držák osvětlení bubnu nahoře.

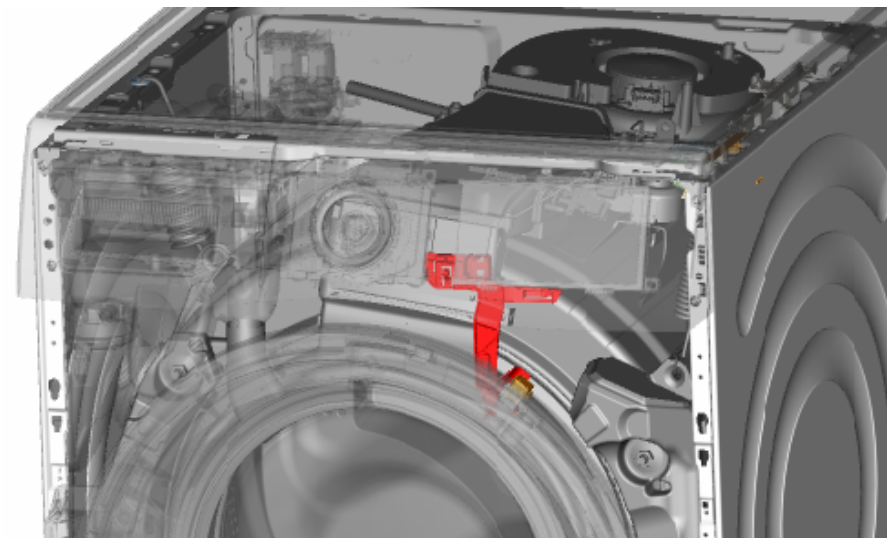

- 9.



POZOR!

Nebezpečí poškození povrchu!

Povrch spotřebiče může být při použití nesprávného náradí poškrábán.

- ▶ K výměně napínacího kroužku používejte pouze plastové náradí.

Plastovým náradím vyjměte napínací kroužek z těsnění.

10. Z předního panelu vyjměte těsnění dvířek.
11. Z pojistky dvířek vyjměte konektor kabelu.

12. Uvolněte šrouby na horní straně předního panelu (3).

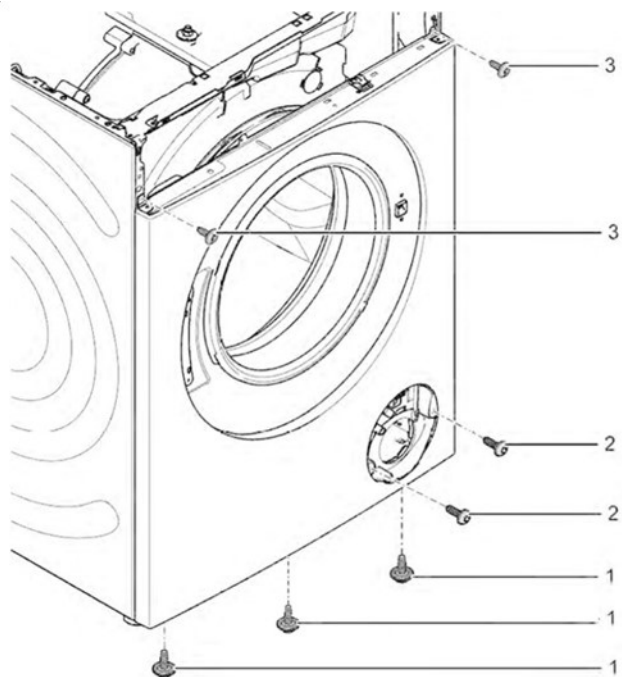

13. Sejměte přední panel.

14. Uvolněte všechny hadicové spoje.

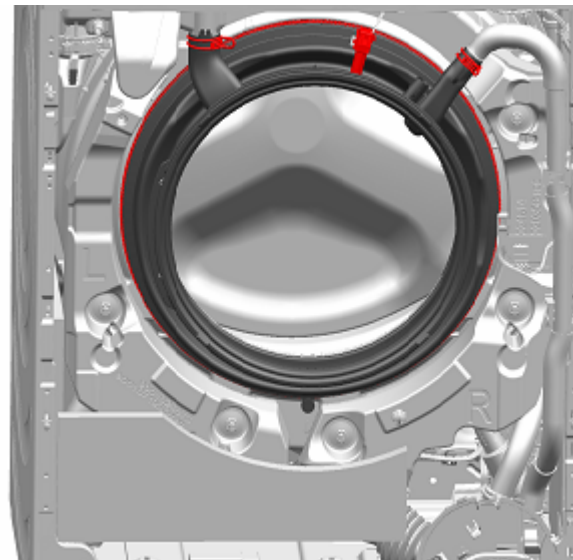

15. Odstraňte těsnění dvířek.

4.7.2 Montáž těsnění dvířek



VÝSTRAHA

Nebezpečí padajících dílů z důvodu nesprávné montáže!

Zranění nebo poškození spotřebiče.

- ▶ Utáhněte napínací kroužek těsnění utahovacím momentem 3,4 Nm.

- ▶ Montáž proveďte v opačném sledu.

4.8 Výměna pojistky dvířek

V souladu s nařízením (EU) 2019/2023 jsme coby výrobce povinni poskytnout spotřebitelům náhradní pojistku dvířek včetně návodu k opravě. Upozorňujeme však na to, že po výměně pojistky dvířek je před uvedením zařízení do provozu vyžadována elektrotechnická bezpečnostní zkouška kvalifikovaným elektrikářem. Tato osoba musí být prokazatelně kvalifikovaná podle zákonů, předpisů a norem platných v dané zemi.

	⚠ NEBEZPEČÍ
	<p>Nebezpečí úrazu elektrickým proudem při dotyku dílů pod proudem! V případě neodborné opravy hrozí nebezpečí smrtelného úrazu elektrickým proudem</p> <ul style="list-style-type: none"> ▶ Opravu elektrického zařízení smí provádět jen kvalifikovaný elektrikář. ▶ Po opravě nechte provést bezpečnostní zkoušku podle VDE 0701 nebo specifických předpisů dané země.

	⚠ POZOR
	<p>Ostré hrany skříně! Nebezpečí řezných poranění</p> <ul style="list-style-type: none"> ▶ Používejte ochranné rukavice.

	⚠ VÝSTRAHA
	<p>Sklouznutí nakloněných spotřebičů! Zlomeniny / poranění rozdrčením</p> <ul style="list-style-type: none"> ▶ Zajistěte spotřebiče proti sklouznutí.

	⚠ POZOR
	<p>Nebezpečí padajících dílů kvůli uvolněným šroubům! Poranění padajícími díly.</p> <ul style="list-style-type: none"> ▶ Zajistěte jednotlivé součásti před pádem.

	POZOR!
	<p>Nebezpečí padajících dílů kvůli uvolněným šroubům! Poškození jiných částí spotřebiče nebo prvků domácnosti zákazníka, např. podlahy.</p> <ul style="list-style-type: none"> ▶ Zajistěte jednotlivé součásti před pádem.

Požadavek:

- ✔ Spotřebič je odpojený od přívodu elektrické energie.

- ✔ Spotřebič je odpojený od přívodu vody.
- ✔ Spotřebič je volně přístupný.
- ✔ [Pracovní deska je sejmutá.→51](#)
- ✔ Panel obložení je odstraněný.
- ✔ [Dvířka jsou odstraněná.→55](#)
- ✔ Napínací kroužek je vyjmutý.
- ✔ Přední panel je odstraněný.
- ✔ Těsnění dvířek je vyjmuto.

4.8.1 Odstranění pojistky dvířek

1. Vytáhněte zástrčku pojistky dvířek.
2. Uvolněte pojistku dvířek.



3. Odstraňte pojistku dvířek.



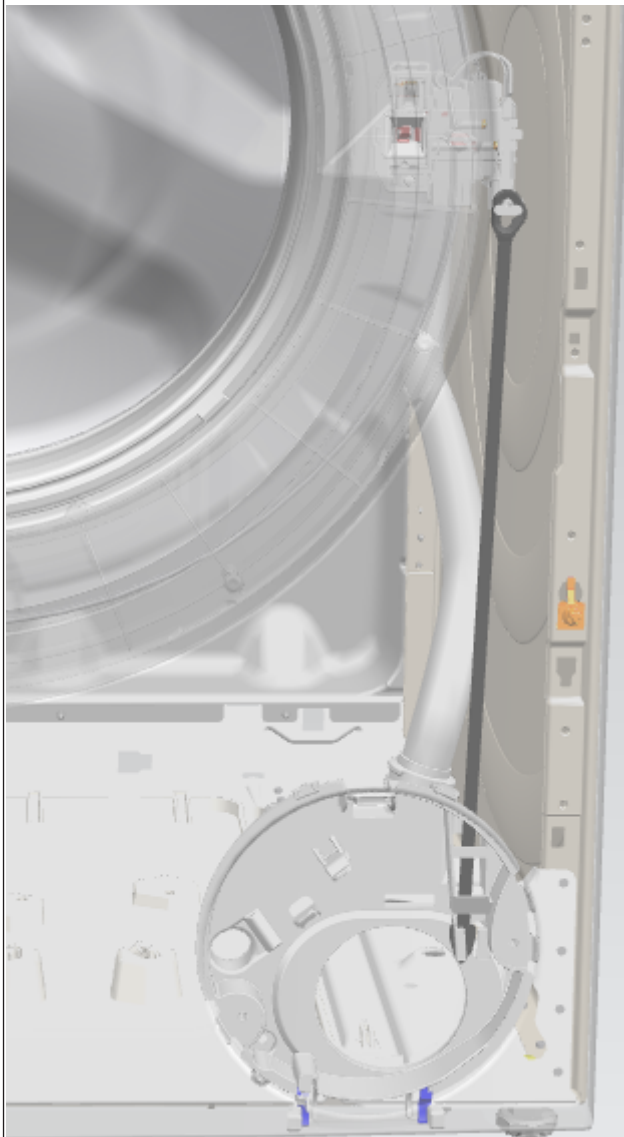

4.8.2 Montáž pojistky dvířek

Pojistka dvířek musí být ve správné poloze, aby byla zajištěna správná funkce nouzového otvírání dvířek spotřebiče.



- ▶ Montáž proveďte v opačném sledu.

4.9 Výměna osvětlení bubnu

	<p>⚠ POZOR</p> <p>Ostré hrany skříně! Nebezpečí řezných poranění</p> <ul style="list-style-type: none">▶ Používejte ochranné rukavice.
	<p>⚠ VÝSTRAHA</p> <p>Sklouznutí nakloněných spotřebičů! Zlomeniny / poranění rozdrčením</p> <ul style="list-style-type: none">▶ Zajistěte spotřebiče proti sklouznutí.
	<p>⚠ POZOR</p> <p>Nebezpečí padajících dílů kvůli uvolněným šroubům! Poranění padajícími díly.</p> <ul style="list-style-type: none">▶ Zajistěte jednotlivé součásti před pádem.
	<p>POZOR!</p> <p>Nebezpečí padajících dílů kvůli uvolněným šroubům! Poškození jiných částí spotřebiče nebo prvků domácnosti zákazníka, např. podlahy.</p> <ul style="list-style-type: none">▶ Zajistěte jednotlivé součásti před pádem.

Požadavek:

- ✔ Spotřebič je odpojený od přívodu elektrické energie.
- ✔ Spotřebič je odpojený od přívodu vody.
- ✔ Spotřebič je volně přístupný.
- ✔ [Pracovní deska je sejmutá.→51](#)
- ✔ [Zásuvka na prací prostředek je vyjmutá.→53](#)
- ✔ Panel obložení je odstraněný.

4.9.1 Odstranění osvětlení bubnu

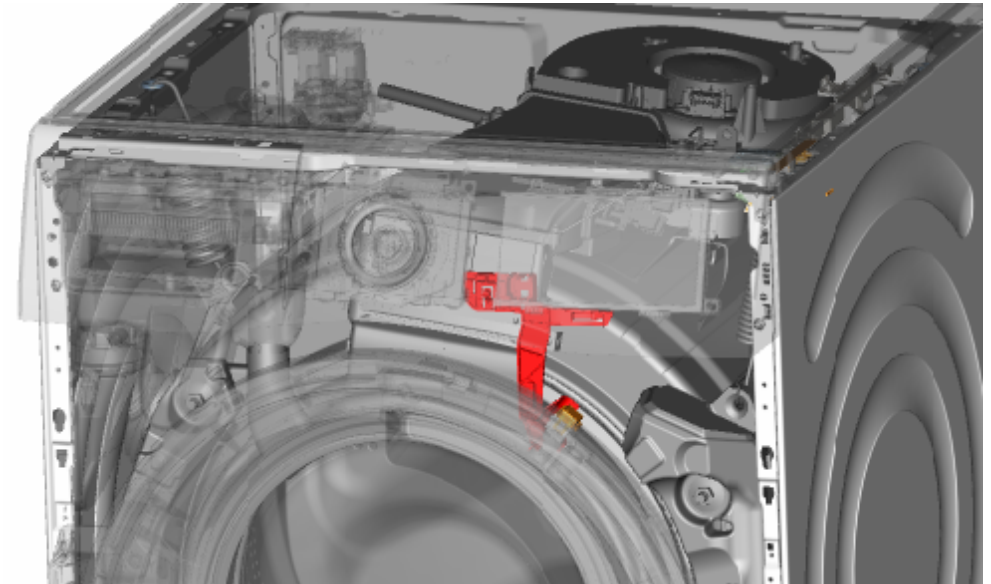

1. Ze spotřebiče vytáhněte držák osvětlení bubnu.
2. Odpojte elektrické připojení.
3. Vyjměte osvětlení bubnu z držáku osvětlení.

4.9.2 Montáž osvětlení bubnu

- ▶ Montáž proveďte v opačném sledu.

4.10 Výměna krytu čerpadla

Požadavek:

- ✔ Spotřebič je odpojený od přívodu elektrické energie.
- ✔ Spotřebič je odpojený od přívodu vody.

4.10.1 Odstranění krytu čerpadla

1. Otevřete kryt čerpadla.

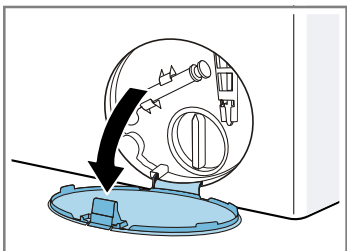

2. Odstraňte kryt čerpadla.

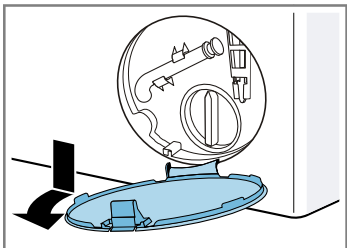

4.10.2 Montáž krytu čerpadla

- ▶ Montáž provedte v opačném sledu.

4.11 Výměna předního panelu



POZOR

Ostré hrany skříně!

Nebezpečí řezných poranění
► Používejte ochranné rukavice.

Požadavek:

- ✔ Spotřebič je odpojený od přívodu elektrické energie.
- ✔ Spotřebič je odpojený od přívodu vody.
- ✔ [Zásuvka na prací prostředek je vyjmutá.→53](#)
- ✔ [Dvířka jsou odstraněná.→55](#)
- ✔ Těsnění dvířek je vyjmuto.
- ✔ [Kryt čerpadla je odstraněný.→64](#)

4.11.1 Sejmutí předního panelu

1.



VÝSTRAHA

Sklouznutí nakloněných spotřebičů!

Zlomeniny / poranění rozdrcením
► Zajistěte spotřebiče proti sklouznutí.

Zvedněte přední část spotřebiče.

2. Odstraňte šrouby ve spodní části (1).

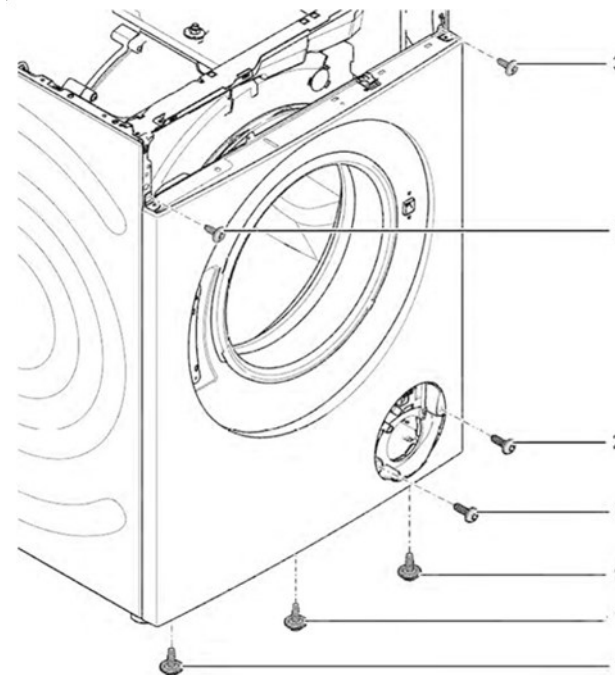

3. Položte spotřebič.

Oprava

4. 1. Odstraňte šrouby (1).
2. Posuňte pracovní desku do zadní části spotřebiče (2).
3. Zvedněte pracovní desku nahoru (3) a sejměte ji.

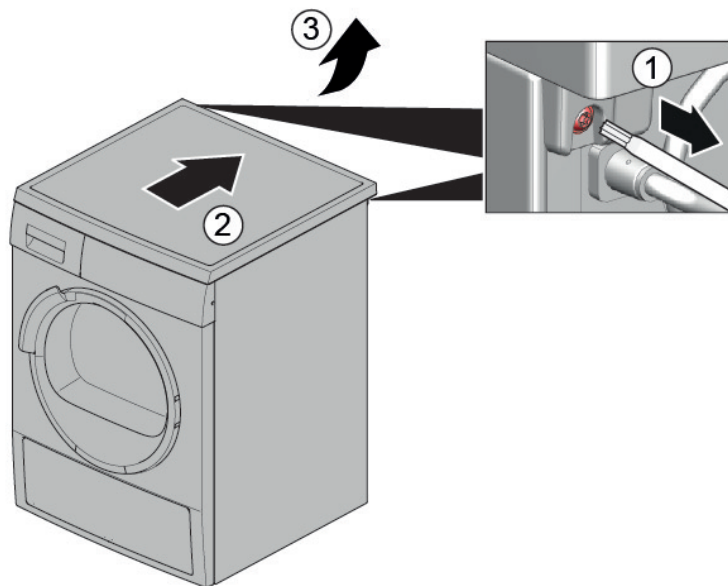

5. 1. Odstraňte šrouby (1).
2. Uvolněte západky (2, 3).

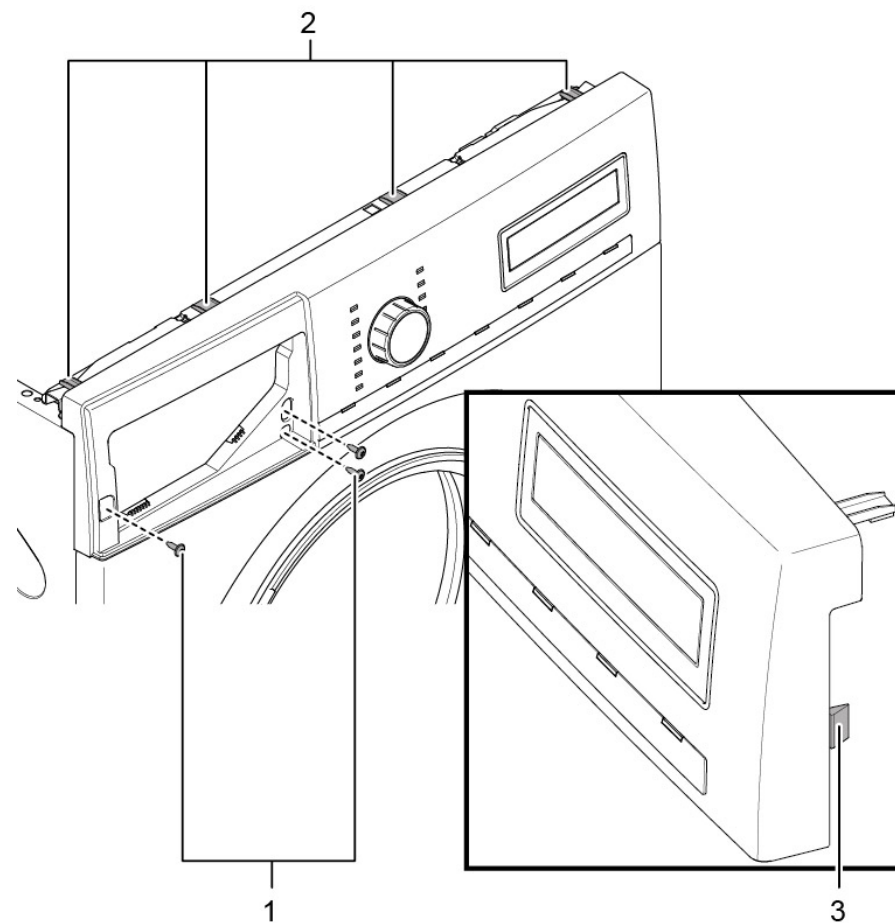

6. Sejměte panel obložení.

7.



POZOR

Nebezpečí padajících dílů kvůli uvolněným šroubům!
Poranění padajícími díly.
► Zajistěte jednotlivé součásti před pádem.



POZOR!

Nebezpečí padajících dílů kvůli uvolněným šroubům!

Poškození jiných částí spotřebiče nebo prvků domácnosti zákazníka, např. podlahy.

- ▶ Zajistěte jednotlivé součásti před pádem.

V přední části odstraňte šrouby, postupujte zdola nahoru (2, 3).

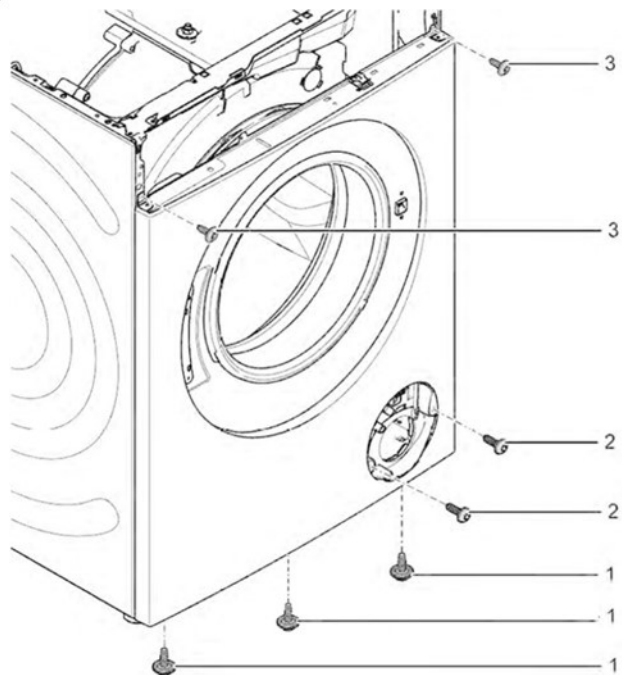





8. Sejměte přední panel.

4.11.2 Montáž předního panelu

- ▶ Montáž proveďte v opačném sledu.

Tip til reparation - Vaskemaskine

 Om dette dokument	69	4.8 Udskiftning af dørlås	83
1.1 Vigtig information.....	69	4.8.1 Fjernelse af dørlås.....	83
1.1.1 Formål.....	69	4.8.2 Montering af dørlås.....	84
1.2 Forklaring af symboler	69	4.9 Udskiftning af tromlelyse	85
1.2.1 Fareniveauer	69	4.9.1 Fjernelse af tromlelyse.....	85
1.2.2 Faresymboler.....	69	4.9.2 Montering af tromlelyse.....	85
1.2.3 Advarslernes opbygning	70	4.10 Udskiftning af pumpens afdækning	86
1.2.4 Generelle symboler	70	4.10.1 Fjernelse af pumpens afdækning.....	86
 Sikkerhed	71	4.10.2 Montering af pumpens afdækning.....	86
2.1 Generelle sikkerhedsanvisninger	71	4.11 Udskiftning af frontpanel.....	87
2.1.1 Alle husholdningsapparater	71	4.11.1 Fjernelse af frontpanel	87
 Værktøjer og hjælpemidler	72	4.11.2 Montering af frontpanel	89
 Reparation	73		
4.1 Udskiftning af topplade	73		
4.1.1 Fjernelse af topplade.....	73		
4.1.2 Montering af topplade.....	73		
4.2 Udskiftning af betjeningspanel.....	74		
4.2.1 Fjernelse af betjeningspanel	74		
4.2.2 Montering af betjeningspanel	74		
4.3 Udskiftning af sæbeskuffe	75		
4.3.1 Fjernelse af sæbeskuffe	75		
4.3.2 Montering af sæbeskuffe	75		
4.4 Udskiftning af sæbeskuffens håndtag	76		
4.4.1 Fjernelse af sæbeskuffens håndtag.....	76		
4.4.2 Montering af sæbeskuffens håndtag.....	76		
4.5 Udskiftning af dør	77		
4.5.1 Fjernelse af dør.....	77		
4.5.2 Montering af dør	77		
4.6 Udskiftning af dørkomponenter.....	78		
4.6.1 Fjernelse af dørkomponenter	78		
4.6.2 Montering af dørkomponenter	78		
4.7 Udskiftning af dørpakning.....	79		
4.7.1 Fjernelse af dørpakning.....	79		
4.7.2 Montering af dørpakning.....	82		

i Om dette dokument

1.1 Vigtig information

1.1.1 Formål

Disse reparationsanvisninger hjælper kunden til selv at kunne reparere apparater i henhold til den gældende lovgivning om miljøvenligt design (fra 03/2021).





De indeholder information om, hvordan der udskiftes bestemte reservedele, herunder advarsler og risici.

Kontakt kundeservice i tilfælde af spørgsmål. Vi påtager os kun ansvar for skader, hvis reparationsanvisningerne er fuldt korrekt.

1.2 Forklaring af symboler

1.2.1 Fareniveauer

Advarselsniveauerne består af et symbol og et signalford. Signalfordene indikerer farens alvor.





Advarselsniveau	Betydning
	Manglende overholdelse af advarselsmeddelelsen vil medføre død eller alvorlige kvæstelser.
	Manglende overholdelse af advarselsmeddelelsen kan medføre død eller alvorlige kvæstelser.
	Manglende overholdelse af advarselsmeddelelsen kan medføre mindre kvæstelser.
	Manglende overholdelse af advarselsmeddelelsen kan medføre materiel beskadigelse.

Tabel 1: Fareniveauer





1.2.2 Faresymboler

Faresymboler er symbolske visninger, der giver en indikation af faretypen.

Der anvendes følgende faresymboler i dette dokument:

Faresymbol	Betydning
	Generel advarselsmeddelelse
	Fare for elektrisk spænding
	Eksplussionsfare
	Fare for at skære sig

i Om dette dokument

Faresymbol	Betydning
	Fare for klemning
	Fare pga. varme overflader
	Fare pga. kraftigt magnetfelt
	Fare pga. ikke-ioniserende stråling

Tabel 2: Faresymboler

1.2.3 Advarslernes opbygning

Advarsler i dette dokument har et standardiseret udseende og en standardiseret opbygning.

	<div style="background-color: red; color: white; padding: 2px; text-align: center;">FARE</div> <p>Farens type og kilde! Mulige følger, hvis faren/advarslen ignoreres.</p> <ul style="list-style-type: none"> ▶ Foranstaltninger og forbud for at forhindre faren.
--	---

De følgende eksempler viser en advarsel, der advarer mod elektrisk stød pga. spændingsførende dele. Foranstaltningen til at undgå faren er nævnt.

	<div style="background-color: red; color: white; padding: 2px; text-align: center;">FARE</div> <p>Fare for elektrisk stød pga. spændingsførende dele! Død ved elektrisk stød</p> <ul style="list-style-type: none"> ▶ Afbryd apparater fra strømforsyningen i mindst 60 sekunder, før reparationer påbegyndes.
--	---

1.2.4 Generelle symboler

Der anvendes følgende generelle symboler i dette dokument:

Generelt symbol	Betydning
	Angivelse af et særligt tip (tekst og/eller grafik)
	Angivelse af et simpelt tip (kun tekst)
	Angivelse af et link til en videotutorial
	Angivelse af nødvendige værktøjer
	Angivelse af krævede forudsætninger
	Angivelse af en betingelse (hvis..., så...)
	Angivelse af et resultat
	Angivelse af en tast eller knap
	Angivelse af et materialenummer
	Angivelse af en vist tekst/et vist vindue (i apparatets display)

Tabel 3: Generelle symboler

2.1 Generelle sikkerhedsanvisninger

2.1.1 Alle husholdningsapparater

Fare for elektrisk stød pga. spændingsførende dele!

- Fejl i forbindelse med reparationer, der involverer elektriske komponenter, kan medføre elektrisk stød!
- Afbryd apparatet fra strømnettet i mindst 60 sekunder, før arbejdet påbegyndes.
- Få efter reparationen udført en sikkerhedstest i henhold til VDE 0701 eller landespecifikke forskrifter.

Fare for tilskadekomst pga. skarpe kanter!

- Brug beskyttelseshandsker.

Fare for klemning i forbindelse med reparation, vedligeholdelse, fejlafhjælpning og service på grund af tunge og bevægelige komponenter

- Brug sikkerhedssko.
- Sørg for at sikre tunge komponenter mod at falde ned.
- Stik kropsdele ind i bevægelige komponenter.







Fare for apparatets sikkerhed/funktion!





- Brug kun originale reservedele.

Fare for beskadigelse af elektrostatisk følsomme komponenter (elektrostatiske afladninger)!

- Berør ikke modulerne, herunder forbindelser og ledningsbaner.

Værktøjer og hjælpemidler

Betegnelse	Detaljer	Billeder
Hjælpeværktøj [15000155]	Værktøj til at løsne plastikdele ud	
Skruetrækker Torx T20 med borehul [00340764]	100 mm for skruer med sikringsstift	
Momentnøgle [15000441]	Momentnøgle 20 - 100 Nm	
Kærviskruestrækker [00340854]	Blad 3,5 mm x 0,6 mm x 100 mm, beskyttelsesisolering 1000 V AC	
Kærviskruestrækker [00340855]	Blad 5,5 mm x 1,0 mm x 125 mm, beskyttelsesisolering 1000 V AC	
Nåletænger, vinklet [00341269]	Længde 200 mm	
Bidetænger [00342182]	Længde: 200 mm	



Betegnelse	Detaljer	Billeder
Fastnøgle [00340811]	Fastnøgle størrelse 10 ^o mm, M6	
Combination wrench [00340814]	Fastnøgle størrelse 13 ^o mm, M8	
Fastnøgle [00340817]	Fastnøgle størrelse 17 mm, M10	
Fastnøgle [15000459]	Fastnøgle størrelse 16 ^o mm, M10	

4.1 Udskiftning af topplade

Nødvendig værktøj:

-  Torx-bit TX20 med hul, lang 6,3°mm (1/4") 152°mm for skruer med [00341272] sikringsstift

Preindstilling:

-  Apparatet er afbrudt fra strømforsyningen.
-  Apparatet er afbrudt fra vandforsyningen.

4.1.1 Fjernelse af topplade

- ▶ 1. Fjern skruerne (1).
- ▶ 2. Skub toppladen bagud på apparatet (2).
- ▶ 3. Bevæg toppladen opad (3) for at fjerne den.

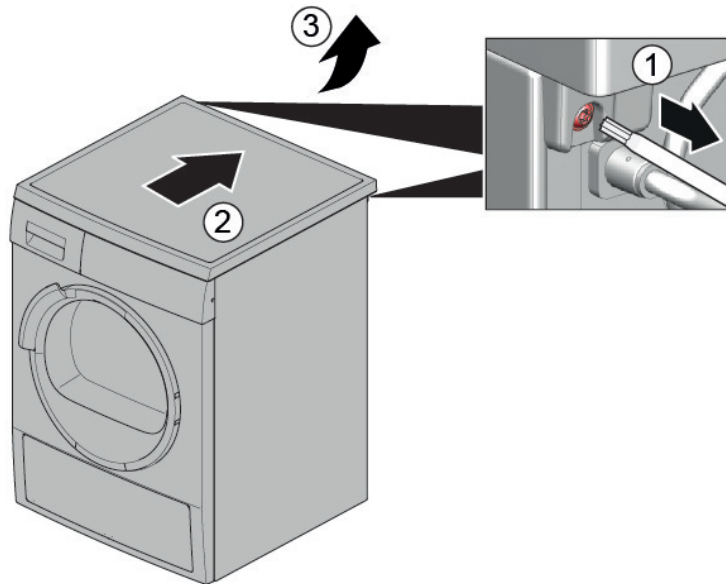

4.1.2 Montering af topplade

- ▶ Montér i omvendt rækkefølge.

4.2 Udskiftning af betjeningspanel



⚠️ PAS PÅ!

Skarpe huskanter!
Snitlæsioner
▶ Brug beskyttelseshandsker.



⚠️ ADVARSEL

Apparater på skrå kan glide!
Knoglebrud/klemeskader
▶ Sørg for at sikre apparater mod at glide.



⚠️ PAS PÅ!

Fare for nedfaldende dele pga. løsnede skruer!
Personskade pga. nedfaldende dele.
▶ Sørg for at sikre komponenten mod at falde ned.



BEMÆRK!

Fare for nedfaldende dele pga. løsnede skruer!
Beskadigelse af andre apparatdele eller kundens hjem, f.eks. gulvet.
▶ Sørg for at sikre komponenten mod at falde ned.

Preindstilling:

- ✔️ Apparatet er afbrudt fra strømforsyningen.
- ✔️ Apparatet er afbrudt fra vandforsyningen.
- ✔️ [Toppladen er fjernet. → 73](#)
- ✔️ [Sæbeskuffen er fjernet. → 75](#)

4.2.1 Fjernelse af betjeningspanel

1. Fjern skruerne (1).
2. Frigør låseelementerne (2, 3).

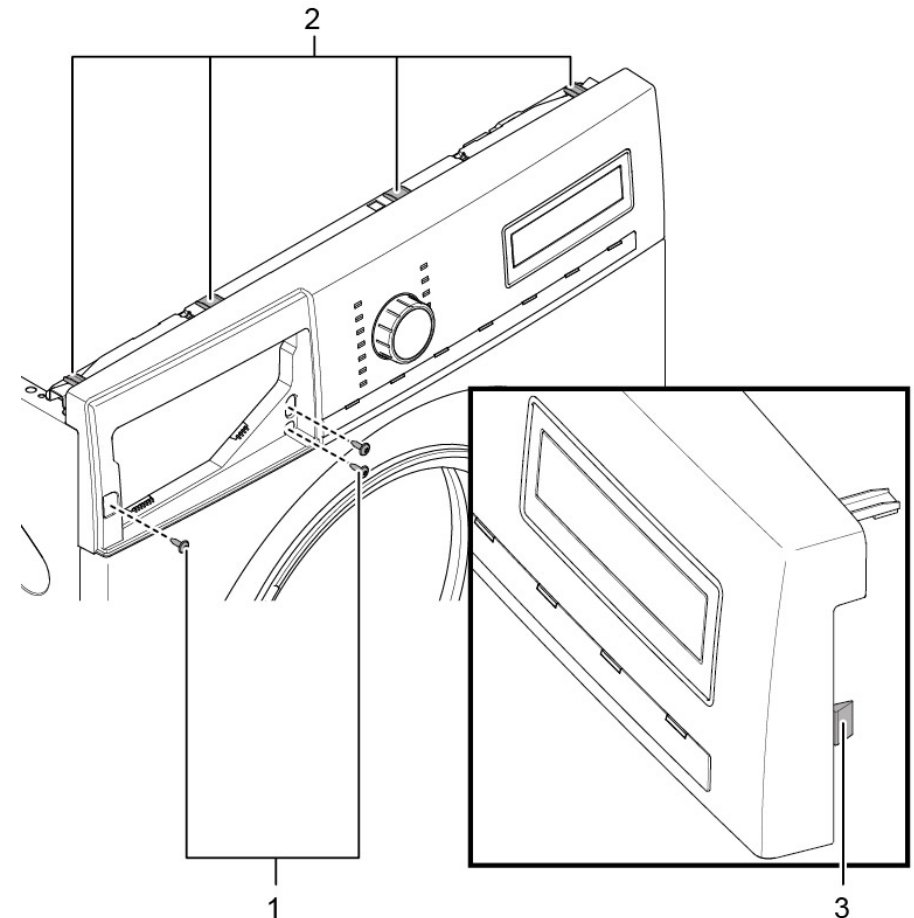

2. Frigør styreenhedens stikkontakt.
3. Fjern betjeningspanelet.

4.2.2 Montering af betjeningspanel

- ▶ Montér i omvendt rækkefølge.

4.3 Udskiftning af sæbeskuffe

Preindstilling:

- ✓ Apparatet er afbrudt fra strømforsyningen.
- ✓ Apparatet er afbrudt fra vandforsyningen.

4.3.1 Fjernelse af sæbeskuffe

1. Træk sæbeskuffen ud.
2. 1. Tryk ned på indsatsen (1).
2. Fjern sæbeskuffen (2).

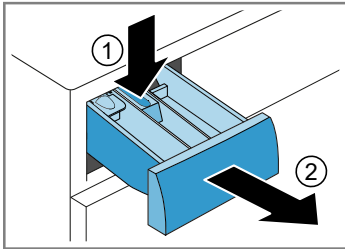

4.3.2 Montering af sæbeskuffe

- ▶ Montér i omvendt rækkefølge.

4.4 Udskiftning af sæbeskuffens håndtag

Preindstilling:

- ✓ Apparatet er afbrudt fra strømforsyningen.
- ✓ Apparatet er afbrudt fra vandforsyningen.
- ✓ [Sæbeskuffen er fjernet.](#) → 75

4.4.1 Fjernelse af sæbeskuffens håndtag

1. Frigør låseelementerne.

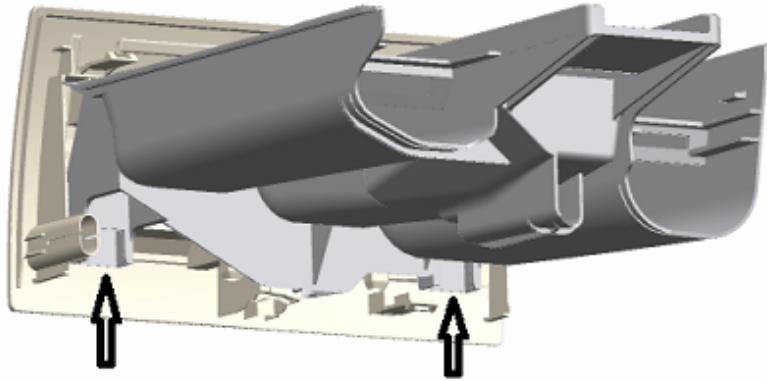

2. Fjern sæbeskuffens håndtag.

4.4.2 Montering af sæbeskuffens håndtag

- ▶ Montér i omvendt rækkefølge.

4.5 Udskiftning af dør



⚠️ PAS PÅ!

Åbent hængselområde!

Fingre kan blive klemt/sætte sig fast

- ▶ Grib ikke ind i hængselområdet.
- ▶ Brug beskyttelseshandsker.

Preindstilling:

- ✔ Apparatet er afbrudt fra strømforsyningen.
- ✔ Apparatet er afbrudt fra vandforsyningen.
- ✔ Døren er åben.

4.5.1 Fjernelse af dør

1.



BEMÆRK!

Fare for nedfaldende dele pga. løsnede skruer!

Beskadigelse af andre apparatdele eller kundens hjem, f.eks. gulvet.

- ▶ Sørg for at sikre komponenten mod at falde ned.



⚠️ PAS PÅ!

Fare for nedfaldende dele pga. løsnede skruer!

Personskade pga. nedfaldende dele.

- ▶ Sørg for at sikre komponenten mod at falde ned.

Fjern skruerne (1).

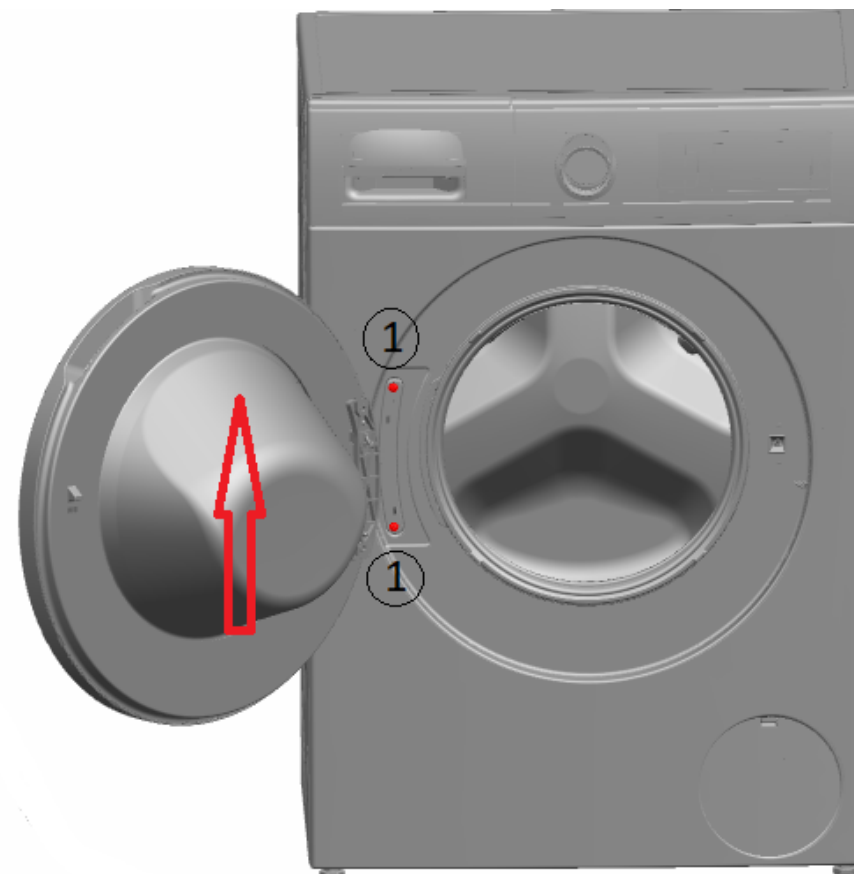

2. Fjern døren opad.

4.5.2 Montering af dør

- ▶ Montér i omvendt rækkefølge.

4.6 Udskiftning af dørkomponenter



⚠ PAS PÅ!

Åbent hængselområde!

Fingre kan blive klemt/sætte sig fast

- ▶ Grib ikke ind i hængselområdet.
- ▶ Brug beskyttelseshandsker.

Preindstilling:

- ✓ Apparatet er afbrudt fra strømforsyningen.
- ✓ Apparatet er afbrudt fra vandforsyningen.
- ✓ [Døren er fjernet.](#) →77

4.6.1 Fjernelse af dørkomponenter

- ▶ Skil døren ad udefra og ind.

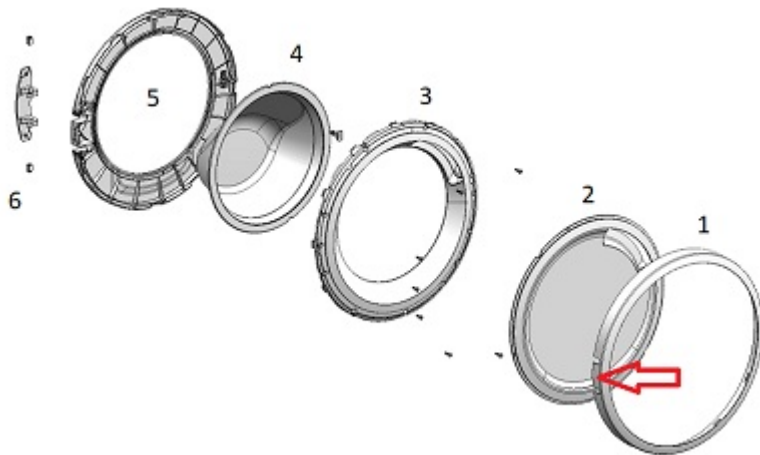

4.6.2 Montering af dørkomponenter

- ▶ Montér i omvendt rækkefølge.

4.7 Udskiftning af dørpakning



⚠️ PAS PÅ!

Skarpe huskanter!
Snitlæsioner
▶ Brug beskyttelseshandsker.



⚠️ PAS PÅ!

Fare for nedfaldende dele pga. løsnede skruer!
Personskade pga. nedfaldende dele.
▶ Sørg for at sikre komponenten mod at falde ned.



BEMÆRK!

Fare for nedfaldende dele pga. løsnede skruer!
Beskadigelse af andre apparatdele eller kundens hjem, f.eks. gulvet.
▶ Sørg for at sikre komponenten mod at falde ned.

Preindstilling:

- ✓ Apparatet er afbrudt fra strømforsyningen.
- ✓ Apparatet er afbrudt fra vandforsyningen.
- ✓ [Sæbeskuffen er fjernet.→75](#)
- ✓ [Døren er fjernet.→77](#)
- ✓ [Pumpens afdækning er fjernet.→86](#)

4.7.1 Fjernelse af dørpakning

1.



⚠️ ADVARSEL

Apparater på skrå kan glide!
Knoglebrud/klemskader
▶ Sørg for at sikre apparater mod at glide.

Løft apparatet op i fronten.

2. Løsn skruerne foruden på frontpanelet (1).

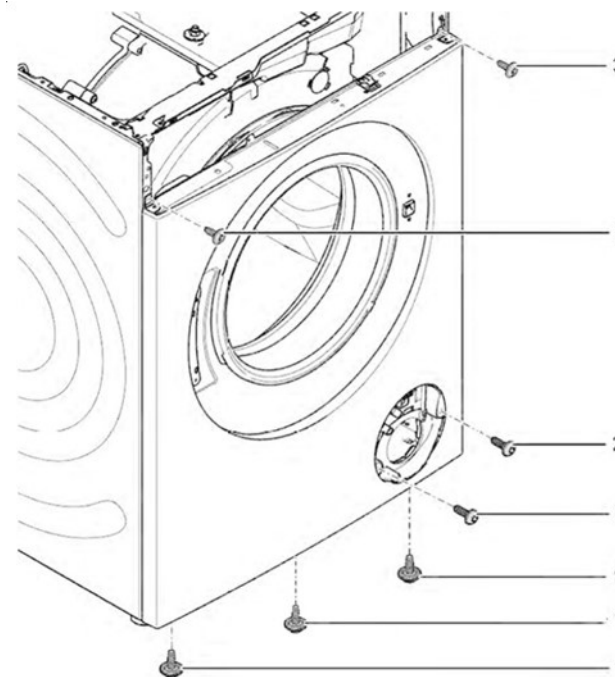

3. Sænk apparatet ned.

Reparation

4. Fjern skruerne i pumpeområdet (2).

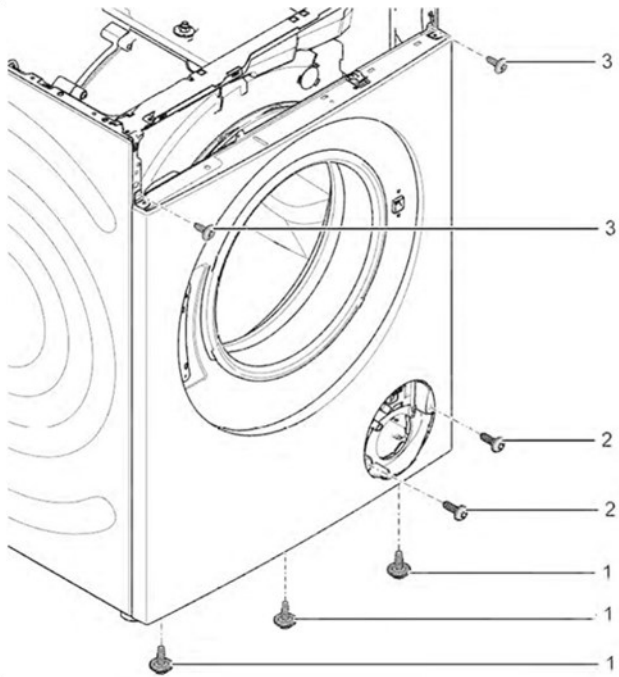

5. 1. Løsn skruerne bag på apparatet (1).
2. Fjern toppladen (2, 3).

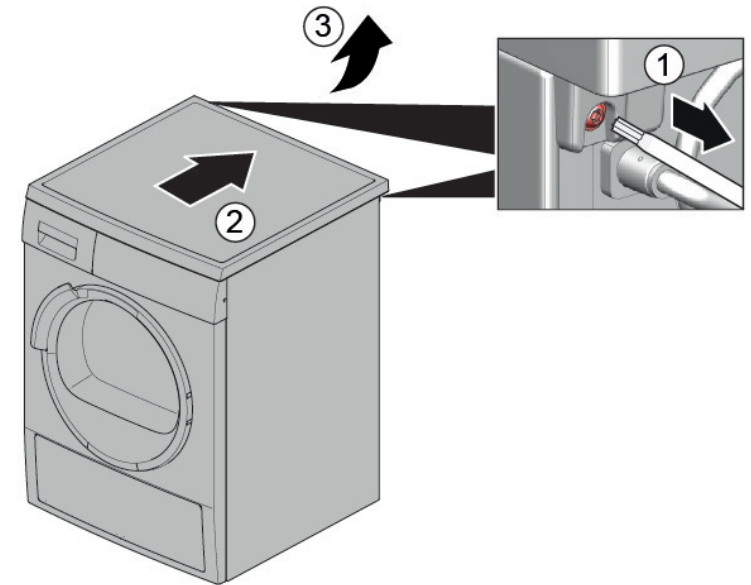

Reparation

6. 1. Fjern skruerne (1).
2. Frigør betjeningspanelets låseelementer (2, 3).
3. Løsn dispenserhusets skruer.

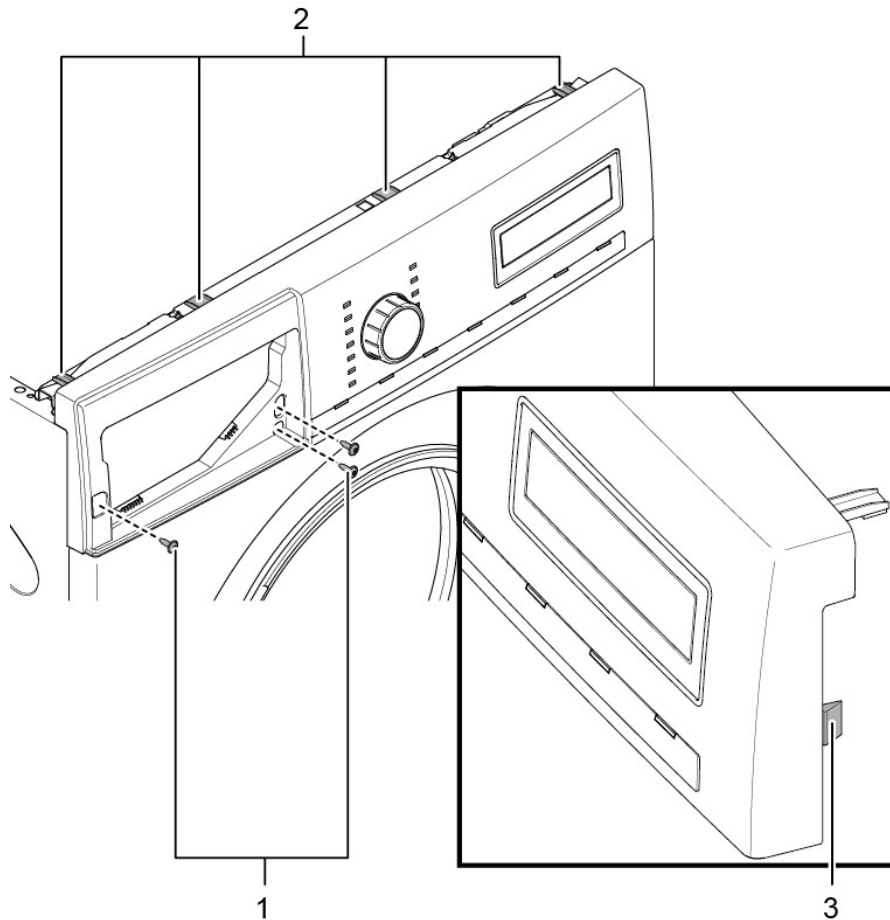

7. Fjern betjeningspanelet.

8. Fjern tromlelysholderen foroven.

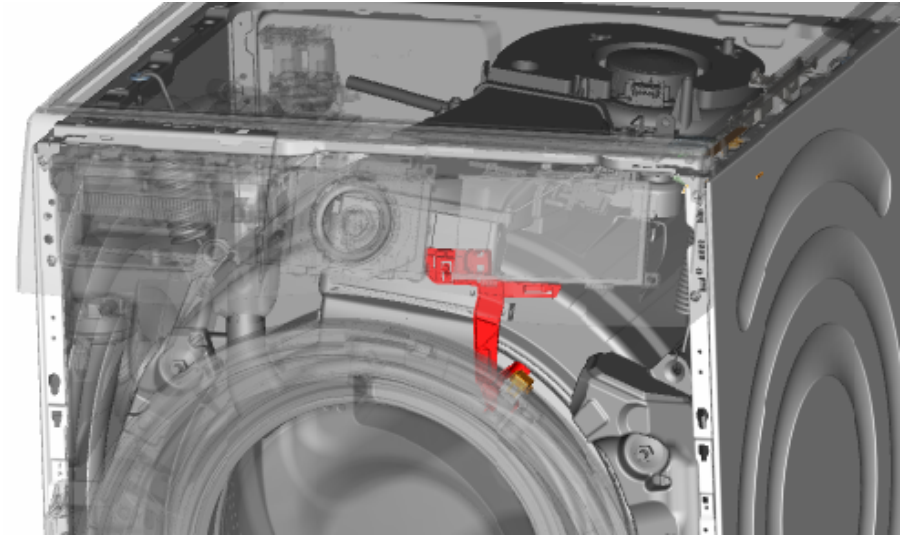

- 9.



BEMÆRK!

Fare for beskadiget overflade!

Apparatets overflade kan blive ridset, hvis der bruges forkerte værktøjer.

- Brug kun plastikværktøjer til at udskifte spænderingen.

Fjern spænderingen fra pakningsringen med et plastikværktøj.

10. Frigør dørpakningen fra frontpanelet.
11. Frigør kabelkonnektoren fra dørlåsen.

12. Løsn skruerne foroven på frontpanelet (3).

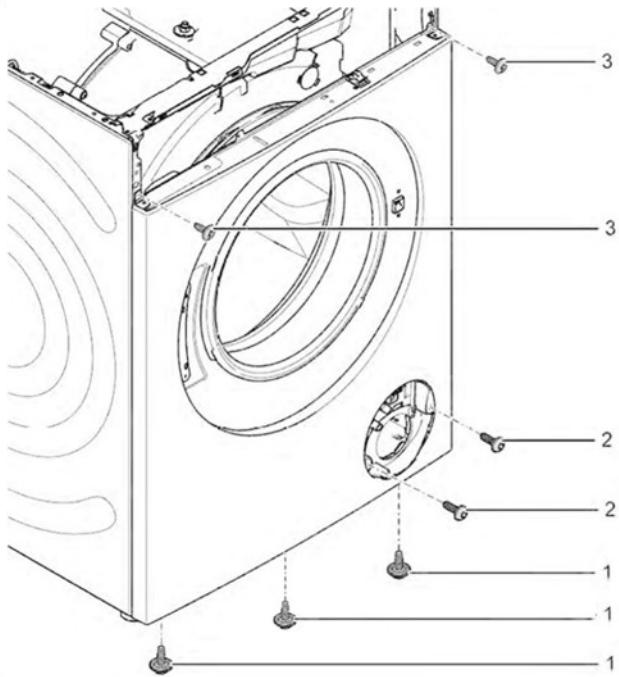

13. Fjern frontpanelet.

14. Frigør alle slangeforbindelser.

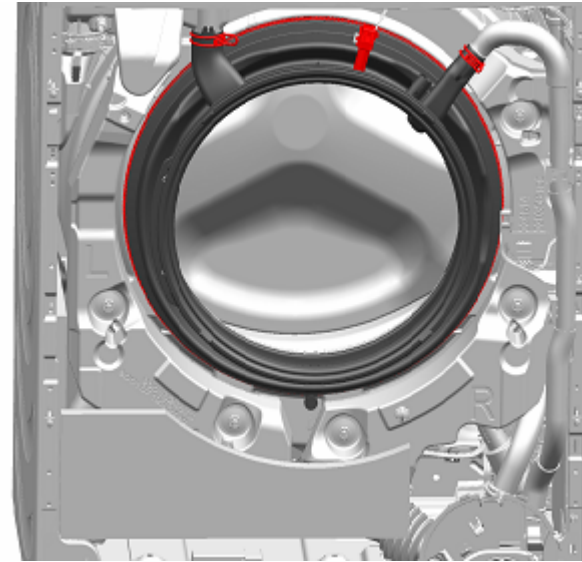

15. Fjern dørpakningen.

4.7.2 Montering af dørpakning



⚠ ADVARSEL

Fare for nedfaldende dele pga. forkert installation!





Fare for tilskadekomst eller beskadigelse af apparatet.

- ▶ Spænd spænderingen på dørbælgen med 3,4 Nm.

- ▶ Monter i omvendt rækkefølge.

4.8 Udskiftning af dørlås

Som producent er vi forpligtet til at sikre kunderne adgang til dørlåsen som reservedel, inklusive reparationsvejledningen, i overensstemmelse med forordning (EU) 2019/2023. Vi gør imidlertid opmærksom på, at det efter udskiftning af dørlåsen er nødvendigt med en elektroteknisk sikkerhedstest, der udføres af en kvalificeret elektriker, før apparatet tages i brug. Denne person skal være dokumenterbart kvalificeret i henhold til landespecifikke love, forskrifter og standarder.

	<p>FARE</p> <p>Fare for elektrisk stød pga. spændingsførende dele! Livsfare pga. elektrisk stød i tilfælde af ukorrekt reparation</p> <ul style="list-style-type: none">▶ Elektriske dele skal repareres af kvalificerede elektrikere.▶ Få efter reparationen udført en sikkerhedstest i henhold til VDE 0701 eller landespecifikke forskrifter.
	<p>PAS PÅ!</p> <p>Skarpe huskanter! Snitlæsioner</p> <ul style="list-style-type: none">▶ Brug beskyttelseshandsker.
	<p>ADVARSEL</p> <p>Apparater på skrå kan glide! Knoglebrud/klemskader</p> <ul style="list-style-type: none">▶ Sørg for at sikre apparater mod at glide.
	<p>PAS PÅ!</p> <p>Fare for nedfaldende dele pga. løsnede skruer! Personskade pga. nedfaldende dele.</p> <ul style="list-style-type: none">▶ Sørg for at sikre komponenten mod at falde ned.
	<p>BEMÆRK!</p> <p>Fare for nedfaldende dele pga. løsnede skruer! Beskadigelse af andre apparatdele eller kundens hjem, f.eks. gulvet.</p> <ul style="list-style-type: none">▶ Sørg for at sikre komponenten mod at falde ned.

Preindstilling:

- ✓ Apparatet er afbrudt fra strømforsyningen.
- ✓ Apparatet er afbrudt fra vandforsyningen.

- ✓ Der er fri adgang til apparaterne.
- ✓ [Toppladen er fjernet.→73](#)
- ✓ Betjeningspanelet er fjernet.
- ✓ [Døren er fjernet.→77](#)
- ✓ Spænderingen er fjernet.
- ✓ Frontpanelet er fjernet.
- ✓ Dørpakningen er fjernet.

4.8.1 Fjernelse af dørlås

1. Træk dørlåsstikket ud.
2. Frigør dørlåsen.



3. Fjern dørlåsen.

4.8.2 Montering af dørlås

Dørlåsen skal være i den korrekte position for at sikre apparatets nød-døråbningsfunktion.



- ▶ Monter i omvendt rækkefølge.

4.9 Udskiftning af tromlelyys



⚠️ PAS PÅ!

Skarpe huskanter!
Snitlæsioner
▶ Brug beskyttelseshandsker.



⚠️ ADVARSEL

Apparater på skrå kan glide!
Knoglebrud/klemskader
▶ Sørg for at sikre apparater mod at glide.



⚠️ PAS PÅ!

Fare for nedfaldende dele pga. løsnede skruer!
Personskade pga. nedfaldende dele.
▶ Sørg for at sikre komponenten mod at falde ned.



BEMÆRK!

Fare for nedfaldende dele pga. løsnede skruer!
Beskadigelse af andre apparatdele eller kundens hjem, f.eks. gulvet.
▶ Sørg for at sikre komponenten mod at falde ned.

Preindstilling:

- ✔️ Apparatet er afbrudt fra strømforsyningen.
- ✔️ Apparatet er afbrudt fra vandforsyningen.
- ✔️ Der er fri adgang til apparaterne.
- ✔️ [Toppladen er fjernet. →73](#)
- ✔️ [Sæbeskuffen er fjernet. →75](#)
- ✔️ Betjeningspanelet er fjernet.

4.9.1 Fjernelse af tromlelyys

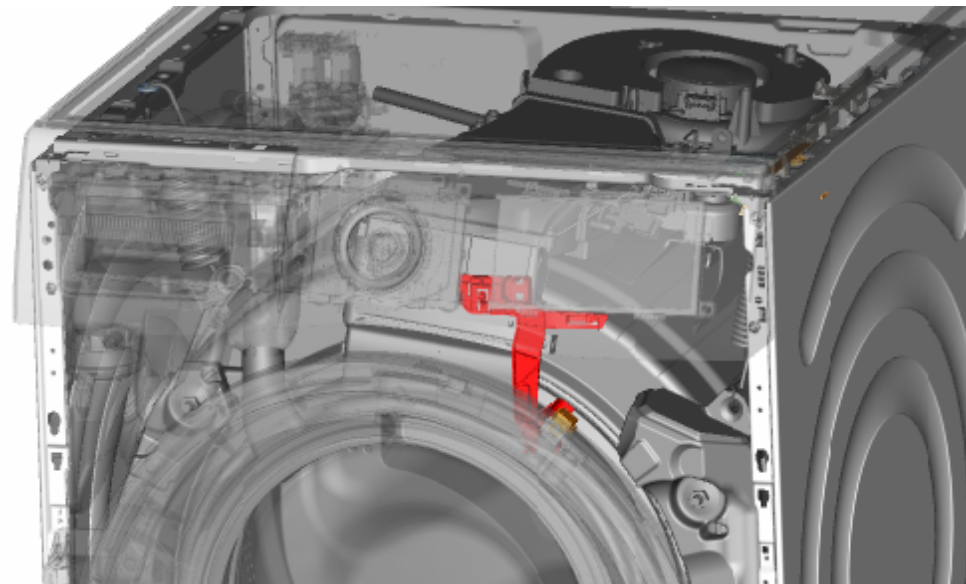

1. Træk tromlelysholderen ud af apparatet.
2. Afbryd de elektriske tilslutninger.
3. Fjern tromlelyset fra tromlelysholderen.

4.9.2 Montering af tromlelyse

- ▶ Montér i omvendt rækkefølge.

4.10 Udskiftning af pumpens afdækning

Preindstilling:

- ✓ Apparatet er afbrudt fra strømforsyningen.
- ✓ Apparatet er afbrudt fra vandforsyningen.

4.10.1 Fjernelse af pumpens afdækning

1. Åbn pumpens afdækning.

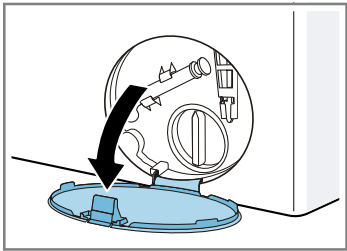

2. Fjern pumpens afdækning.

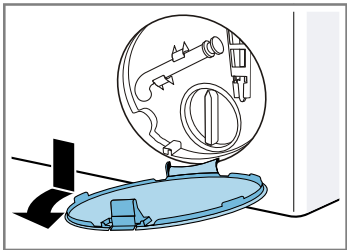

4.10.2 Montering af pumpens afdækning

- ▶ Montér i omvendt rækkefølge.

4.11 Udskiftning af frontpanel



⚠ PAS PÅ!

Skarpe huskanter!
Snitlæsioner
▶ Brug beskyttelseshandsker.

Preindstilling:

- ✓ Apparatet er afbrudt fra strømforsyningen.
- ✓ Apparatet er afbrudt fra vandforsyningen.
- ✓ [Sæbeskuffen er fjernet. →75](#)
- ✓ [Døren er fjernet. →77](#)
- ✓ Dørpakningen er fjernet.
- ✓ [Pumpens afdækning er fjernet. →86](#)

4.11.1 Fjernelse af frontpanel

1.



⚠ ADVARSEL

Apparater på skrå kan glide!
Knoglebrud/klemskader
▶ Sørg for at sikre apparater mod at glide.

Løft apparatet op i fronten.

2. Fjern skruerne forned (1).

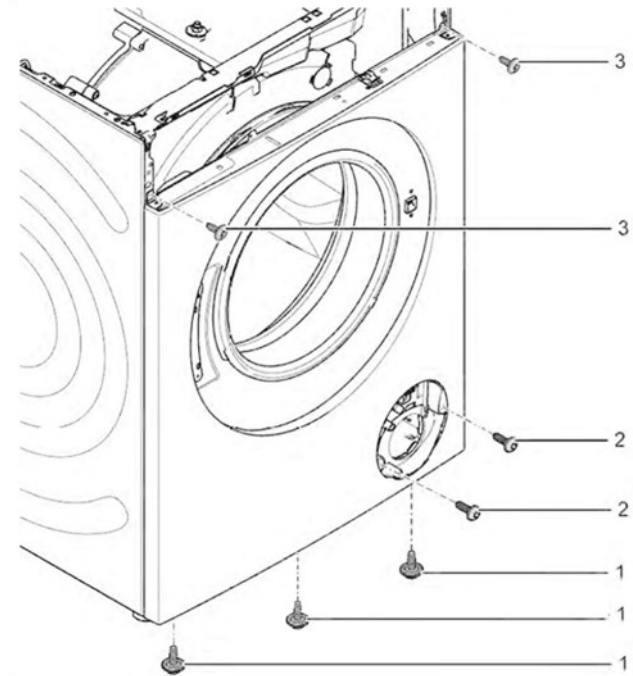

3. Sænk apparatet ned.

Reparation

4. 1. Fjern skruerne (1).
2. Skub toppladen bagud på apparatet (2).
3. Bevæg toppladen opad (3) for at fjerne den.

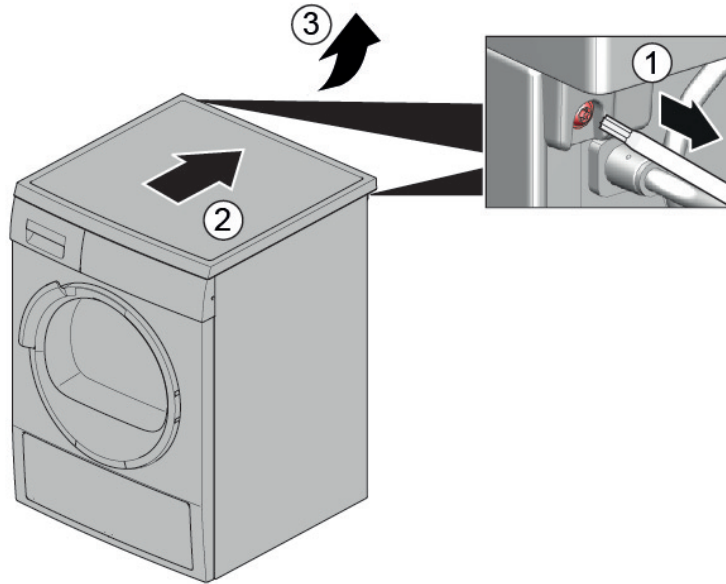

5. 1. Fjern skruerne (1).
2. Frigør låseelementerne (2, 3).

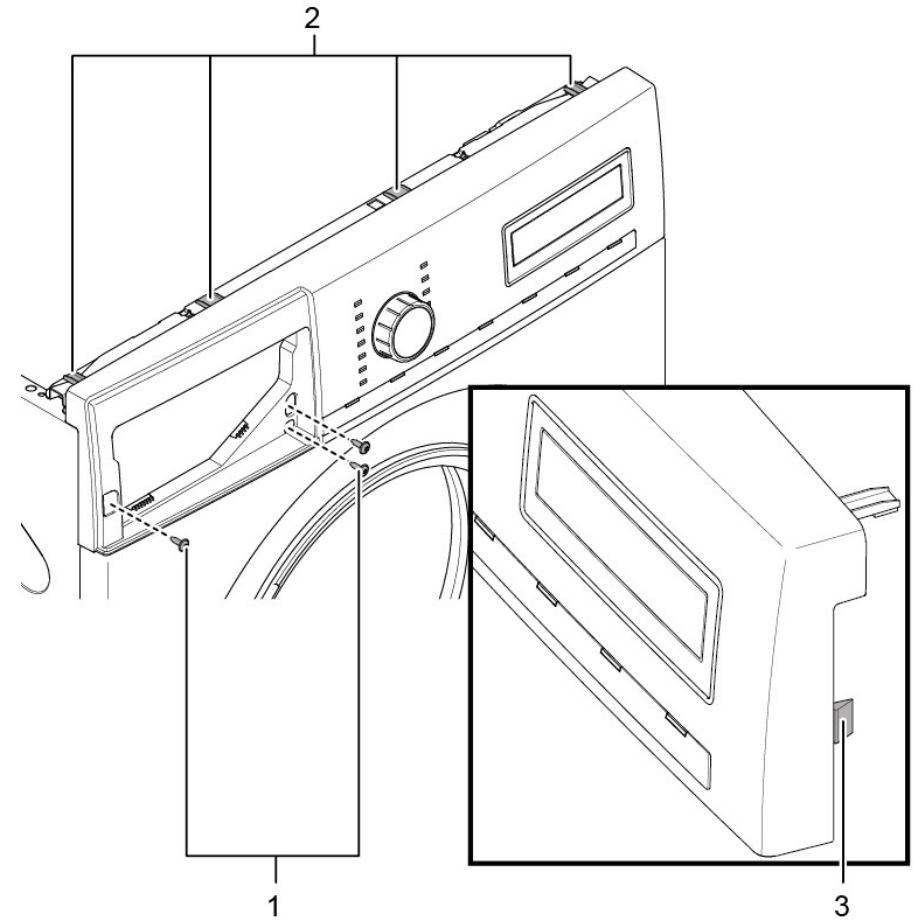

6. Fjern betjeningspanelet.

7.



⚠ PAS PÅ!

Fare for nedfaldende dele pga. løsnede skruer!
Personskade pga. nedfaldende dele.

- Sørg for at sikre komponenten mod at falde ned.



BEMÆRK!

Fare for nedfaldende dele pga. løsnede skruer!

Beskadigelse af andre apparatdele eller kundens hjem, f.eks. gulvet.

- ▶ Sørg for at sikre komponenten mod at falde ned.

Fjern skruerne på fronten ved at starte nedefra og op (2, 3).

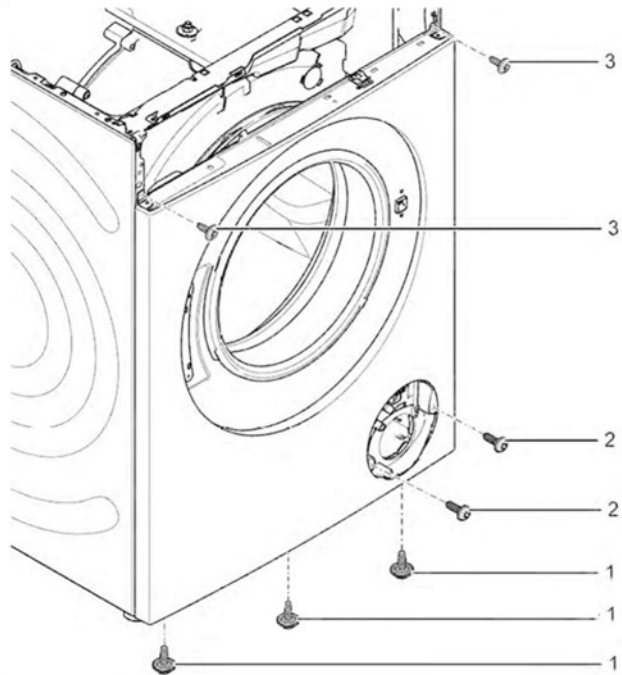





8. Fjern frontpanelet.

4.11.2 Montering af frontpanel

- ▶ Montér i omvendt rækkefølge.

Reparatie informatie - Wasmachine

 Over dit document	91	4.8 Deurslot vervangen	105
1.1 Belangrijke informatie	91	4.8.1 Deurslot verwijderen	105
1.1.1 Doel	91	4.8.2 Deurslot monteren	106
1.2 Verklaring van symbolen	91	4.9 Trommelverlichting vervangen	107
1.2.1 Gevarenniveaus	91	4.9.1 Trommelverlichting verwijderen	107
1.2.2 Gevarensymbolen	91	4.9.2 Trommelverlichting monteren	107
1.2.3 Structuur van de waarschuwingen	92	4.10 Pompdeksel vervangen	108
1.2.4 Algemene symbolen	92	4.10.1 Pompdeksel verwijderen	108
 Veiligheid	93	4.10.2 Pompdeksel monteren	108
2.1 Algemene veiligheidsinstructies	93	4.11 Frontpaneel vervangen	109
2.1.1 Alle huishoudelijke apparaten	93	4.11.1 Frontpaneel verwijderen	109
 Gereedschappen en hulpmiddelen	94	4.11.2 Frontpaneel monteren	111
 Reparatie	95		
4.1 Werkblad vervangen	95		
4.1.1 Werkblad verwijderen	95		
4.1.2 Werkblad monteren	95		
4.2 Bedieningspaneel vervangen	96		
4.2.1 Bedieningspaneel verwijderen	96		
4.2.2 Bedieningspaneel monteren	96		
4.3 Wasmiddellade vervangen	97		
4.3.1 Wasmiddellade verwijderen	97		
4.3.2 Wasmiddellade monteren	97		
4.4 Handgreep wasmiddellade vervangen	98		
4.4.1 Handgreep wasmiddellade verwijderen	98		
4.4.2 Handgreep wasmiddellade monteren	98		
4.5 Deur vervangen	99		
4.5.1 Deur verwijderen	99		
4.5.2 Deur monteren	99		
4.6 Deurcomponenten vervangen	100		
4.6.1 Deurcomponenten verwijderen	100		
4.6.2 Deurcomponenten monteren	100		
4.7 Deurafdichting vervangen	101		
4.7.1 Deurafdichting verwijderen	101		
4.7.2 Deurafdichting monteren	104		

i Over dit document

1.1 Belangrijke informatie

1.1.1 Doel

Met deze reparatieaanwijzingen wordt de klant geholpen zelf apparaten te repareren conform de toepasselijke verordening inzake ecologisch ontwerp (met ingang van 03/2021).





Ze bevatten informatie over hoe gedefinieerde reserveonderdelen kunnen worden vervangen met inbegrip van waarschuwingen en gevaren.

Neem bij vragen contact op met onze klantenservice. We stellen ons alleen aansprakelijk voor schade als de reparatieaanwijzingen correct zijn opgevolgd.

1.2 Verklaring van symbolen

1.2.1 Gevarenniveaus

De waarschuwningsniveaus worden aangegeven met een symbool en een signaalwoord. Het signaalwoord geeft de ernst van het gevaar aan.





Waarschuwningsniveau	Betekenis
	Als de waarschuwing niet in acht wordt genomen, leidt dat tot ernstig of dodelijk letsel.
	Als de waarschuwing niet in acht wordt genomen, kan dat tot ernstig of dodelijk letsel leiden.
	Als de waarschuwing niet in acht wordt genomen, kan dat tot licht letsel leiden.
	Als de waarschuwing niet in acht wordt genomen, kan dat tot materiële schade leiden.

Tabel 1: Gevarenniveaus

1.2.2 Gevarensymbolen

Gevarensymbolen zijn symbolische afbeeldingen die een indicatie geven van het soort gevaar.

De volgende gevarensymbolen worden in dit document gebruikt:

Gevarensymbool	Betekenis
	Algemene waarschuwing
	Gevaar voor elektrische spanning
	Ontploffingsgevaar
	Snijgevaar

i Over dit document

Gevarensymbool	Betekenis
	Beknellingsgevaar
	Gevaar voor hete oppervlakken
	Gevaar voor sterke magnetische velden
	Gevaar voor niet-ioniserende straling

Tabel 2: Gevarensymbolen

1.2.3 Structuur van de waarschuwingen

Waarschuwingen in dit document hebben een gestandaardiseerd uiterlijk en een gestandaardiseerde structuur.







	<div style="background-color: red; color: white; padding: 2px; text-align: center;">⚠ GEVAAR</div> <p>Soort gevaar en bron van het gevaar! Mogelijke gevolgen van het negeren van het gevaar / de waarschuwing.</p> <ul style="list-style-type: none"> ▶ Maatregelen en verboden om het gevaar te voorkomen.
--	---

In het volgende voorbeeld is een waarschuwing te zien waarmee voor een elektrische schok aan stroomvoerende onderdelen wordt gewaarschuwd. De maatregel om het gevaar te vermijden wordt vermeld.

	<div style="background-color: red; color: white; padding: 2px; text-align: center;">⚠ GEVAAR</div> <p>Gevaar voor een elektrische schok aan stroomvoerende onderdelen! Dood door elektrocutie</p> <ul style="list-style-type: none"> ▶ Haal apparaten minstens 60 seconden voor u met reparaties begint van de stroomvoorziening af.
--	---

1.2.4 Algemene symbolen

De volgende algemene symbolen worden in dit document gebruikt:

Alg. symbool	Betekenis
	Identificatie van een speciale tip (tekst en/of afbeelding)
	Identificatie van een eenvoudige tip (tekst)
	Identificatie van een link naar een video-instructie
	Identificatie van vereiste gereedschappen
	Identificatie van vereiste voorwaarden
	Identificatie van een voorwaarde (als ..., dan ...)
	Identificatie van een resultaat
[Start]	Identificatie van een toets of knop
[00123456]	Identificatie van een materiaalnummer
Status	Identificatie van weergegeven tekst / venster (in het display van het apparaat)

Tabel 3: Algemene symbolen

2.1 Algemene veiligheidsinstructies

2.1.1 Alle huishoudelijke apparaten

Gevaar voor een elektrische schok aan stroomvoerende onderdelen!

- Fouten bij reparaties aan elektrische componenten kunnen tot een elektrische schok leiden!
- Koppel het apparaat minstens 60 seconden los van het stroomnet voordat u met de werkzaamheden begint.
- Laat na de reparatie een veiligheidstest conform VDE 0701 of de landspecifieke regelgeving uitvoeren.

Gevaar voor letsel aan scherpe randen!

- Draag veiligheidshandschoenen.

Beknellingsgevaar tijdens reparatie, onderhoud, probleemoplossing en service vanwege zware en bewegende componenten

- Draag veiligheidsschoenen.
- Beveilig zware componenten tegen vallen.
- Steek geen lichaamsdelen in bewegende componenten.







Gevaar voor de veiligheid / werking van het apparaat!





- Gebruik uitsluitend originele reserveonderdelen.

Gevaar voor schade aan elektrostatisch gevoelige componenten (ESD's)!

- Raak de modules met inbegrip van de aansluitingen en geleiderbanen niet aan.

Gereedschappen en hulpmiddelen

Benaming	Details	Afbeeldingen
Hulpgereedschap [15000155]	Gereedschap voor loshalen uit kunststof onderdelen	
Torx T20 schroevendraaier met boorgat [00340764]	100 mm, voor schroeven met borgpen	
Momentsleutel [15000441]	Momentsleutel 20 - 100 Nm	
Sleufschroevendraaier [00340854]	Blad 3,5 mm x 0,6 mm x 100 mm, Beschermende isolatie 1000 V AC	
Sleufschroevendraaier [00340855]	Blad 5,5 mm x 1,0 mm x 125 mm, Beschermende isolatie 1000 V AC	
Naaldtang, gebogen [00341269]	Lengte 200 mm	
Zijsnijtang [00342182]	Lengte: 200 mm	



Benaming	Details	Afbeeldingen
Ring-steeksleutel [00340811]	Maat 10°mm, M6	
Combination wrench [00340814]	Maat 13°mm, M8	
Ring-steeksleutel [00340817]	Maat 17 mm, M10	
Ring-steeksleutel [15000459]	Maat 16°mm, M10	

4.1 Werkblad vervangen

Speciale hulpmiddelen:

-  Torxbit TX20 met gat, lang 6,3°mm (1/4") 152°mm, voor schroeven met borgpen [00341272]

Voorwaarde:

-  Apparaat wordt van de stroomvoorziening afgehaald.
-  Apparaat wordt van de watervoorziening afgehaald.

4.1.1 Werkblad verwijderen

- ▶ 1. Verwijder schroeven (1).
- ▶ 2. Duw het werkblad naar de achterkant van het apparaat (2).
- ▶ 3. Beweeg het werkblad omhoog (3) om het te verwijderen.

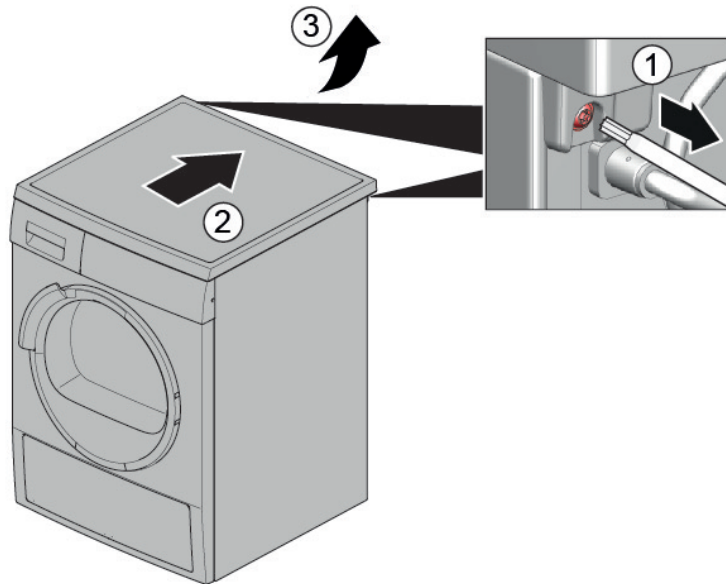

4.1.2 Werkblad monteren

- ▶ Monteer in omgekeerde volgorde.

4.2 Bedieningspaneel vervangen



VOORZICHTIG

Scherpe randen aan de behuizing!

Snijletsel

- ▶ Draag veiligheidshandschoenen.



WAARSCHUWING

Weggliden van schuin staande apparaten!

Botbreuken / beknellingsletsel

- ▶ Beveilig apparaten tegen wegglijden.



VOORZICHTIG

Gevaar voor vallende onderdelen als gevolg van losgeraakte schroeven!

Letsel als gevolg van vallende onderdelen.

- ▶ Beveilig component tegen vallen.



LET OP!

Gevaar voor vallende onderdelen als gevolg van losgeraakte schroeven!

Schade aan andere onderdelen van het apparaat of bij de klant thuis bijvoorbeeld aan de vloer.

- ▶ Beveilig component tegen vallen.

Voorwaarde:

- ✓ Apparaat wordt van de stroomvoorziening afgehaald.
- ✓ Apparaat wordt van de watervoorziening afgehaald.
- ✓ [Werkblad is verwijderd.→95](#)
- ✓ [Wasmiddellade is verwijderd.→97](#)

4.2.1 Bedieningspaneel verwijderen

1. Verwijder schroeven (1).
2. Maak vergrendelelementen (2, 3) los.

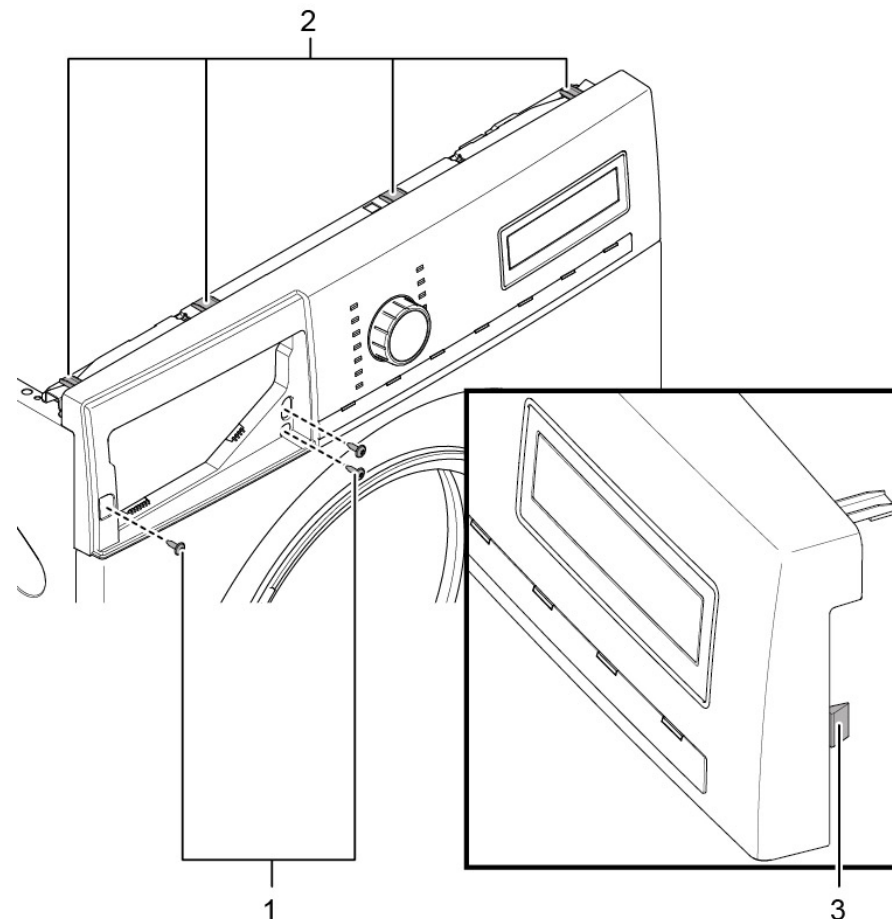

2. Haal de stekerverbinding van de bedieningseenheid los.
3. Verwijder het bedieningspaneel.

4.2.2 Bedieningspaneel monteren

- ▶ Monteer in omgekeerde volgorde.

4.3 Wasmiddellade vervangen

Voorwaarde:

- ✓ Apparaat wordt van de stroomvoorziening afgehaald.
- ✓ Apparaat wordt van de watervoorziening afgehaald.

4.3.1 Wasmiddellade verwijderen

1. Trek de wasmiddellade open.
2. 1. Druk het inzetstuk (1) omlaag.
2. Verwijder de wasmiddellade (2).

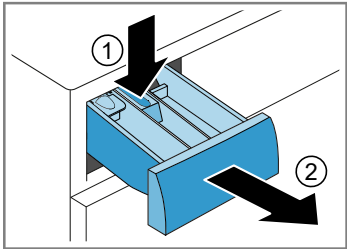

4.3.2 Wasmiddellade monteren

- ▶ Monteer in omgekeerde volgorde.

4.4 Handgreep wasmiddellade vervangen

Voorwaarde:

- ✓ Apparaat wordt van de stroomvoorziening afgehaald.
- ✓ Apparaat wordt van de watervoorziening afgehaald.
- ✓ [Wasmiddellade is verwijderd.→97](#)

4.4.1 Handgreep wasmiddellade verwijderen

1. Maak vergrendelelementen los.

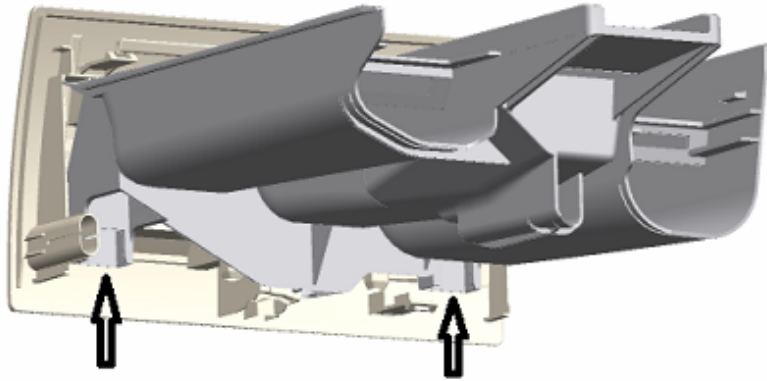

2. Verwijder de handgreep van de wasmiddellade.

4.4.2 Handgreep wasmiddellade monteren

- ▶ Monteer in omgekeerde volgorde.

4.5 Deur vervangen

	<p>⚠️ VOORZICHTIG</p> <p>Maak het scharniergedeelte open! Beknelling/afklemming van vingers</p> <ul style="list-style-type: none">▶ Steek uw vingers niet in het scharniergedeelte.▶ Draag veiligheidshandschoenen.
--	--

Voorwaarde:

- ✔ Apparaat wordt van de stroomvoorziening afgehaald.
- ✔ Apparaat wordt van de watervoorziening afgehaald.
- ✔ Deur wordt geopend.

4.5.1 Deur verwijderen

1.

	<p>LET OP!</p> <p>Gevaar voor vallende onderdelen als gevolg van losgeraakte schroeven! Schade aan andere onderdelen van het apparaat of bij de klant thuis bijvoorbeeld aan de vloer.</p> <ul style="list-style-type: none">▶ Beveilig component tegen vallen.
---	---

	<p>⚠️ VOORZICHTIG</p> <p>Gevaar voor vallende onderdelen als gevolg van losgeraakte schroeven! Letsel als gevolg van vallende onderdelen.</p> <ul style="list-style-type: none">▶ Beveilig component tegen vallen.
--	--

Verwijder schroeven (1).

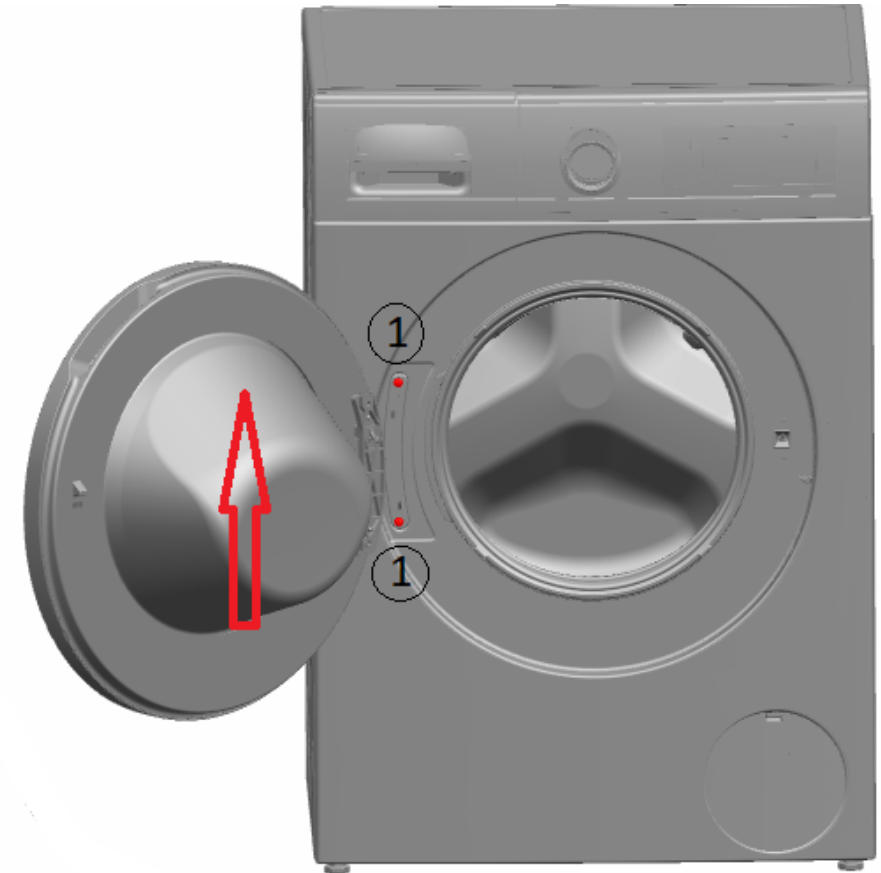

2. Verwijder deur naar boven toe.

4.5.2 Deur monteren

- ▶ Monteer in omgekeerde volgorde.

4.6 Deurcomponenten vervangen



VOORZICHTIG

Maak het scharniergedeelte open!

Beknelling/afklemming van vingers

- ▶ Steek uw vingers niet in het scharniergedeelte.
- ▶ Draag veiligheidshandschoenen.

Voorwaarde:

- ✓ Apparaat wordt van de stroomvoorziening afgehaald.
- ✓ Apparaat wordt van de watervoorziening afgehaald.
- ✓ [Deur is verwijderd.→99](#)

4.6.1 Deurcomponenten verwijderen

- ▶ Demonteer de deur van buiten naar binnen.

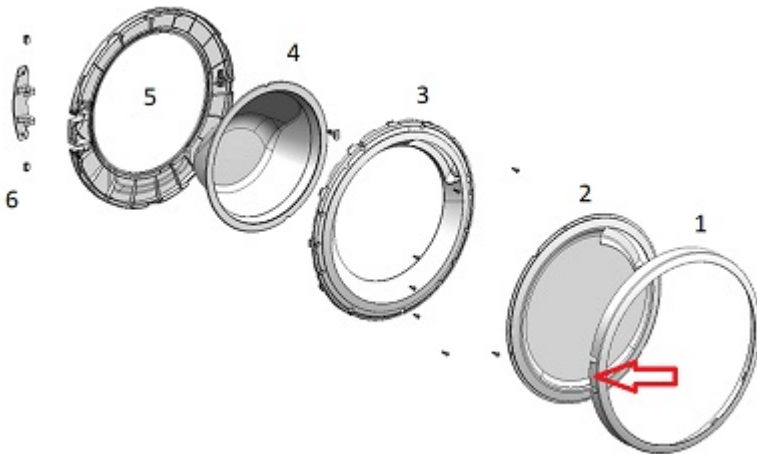

4.6.2 Deurcomponenten monteren

- ▶ Monteer in omgekeerde volgorde.

4.7 Deurafdichting vervangen



⚠ VOORZICHTIG

Scherpe randen aan de behuizing!

Snijletsel

- ▶ Draag veiligheidshandschoenen.



⚠ VOORZICHTIG

Gevaar voor vallende onderdelen als gevolg van losgeraakte schroeven!

Letsel als gevolg van vallende onderdelen.

- ▶ Beveilig component tegen vallen.



LET OP!

Gevaar voor vallende onderdelen als gevolg van losgeraakte schroeven!

Schade aan andere onderdelen van het apparaat of bij de klant thuis bijvoorbeeld aan de vloer.

- ▶ Beveilig component tegen vallen.

Voorwaarde:

- ✓ Apparaat wordt van de stroomvoorziening afgehaald.
- ✓ Apparaat wordt van de watervoorziening afgehaald.
- ✓ [Wasmiddellade is verwijderd.→97](#)
- ✓ [Deur is verwijderd.→99](#)
- ✓ [Pompdeksel is verwijderd.→108](#)

4.7.1 Deurafdichting verwijderen

1.



⚠ WAARSCHUWING

Weggliden van schuin staande apparaten!

Botbreuken / beknellingsletsel

- ▶ Beveilig apparaten tegen wegglijden.

Til het apparaat aan de voorkant op.

2. Draai de schroeven onderaan het frontpaneel (1) los.

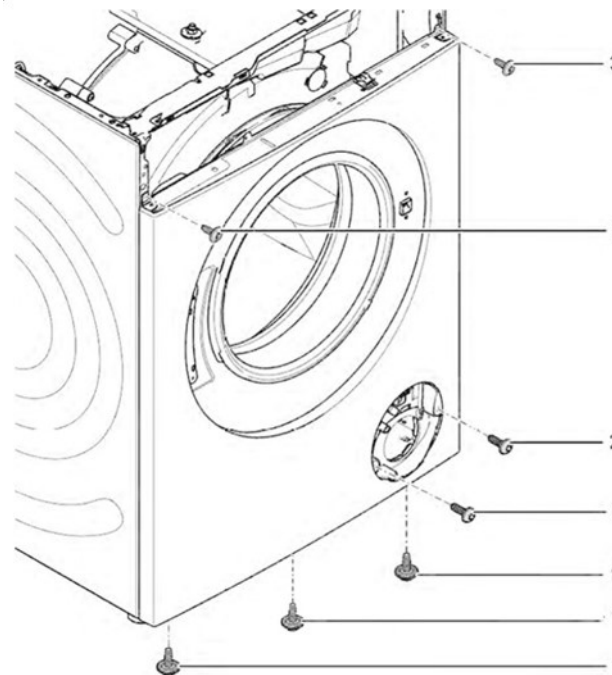

3. Laat het apparaat weer zakken.

Reparatie

4. Verwijder de schroeven in het pompgedeelte (2).

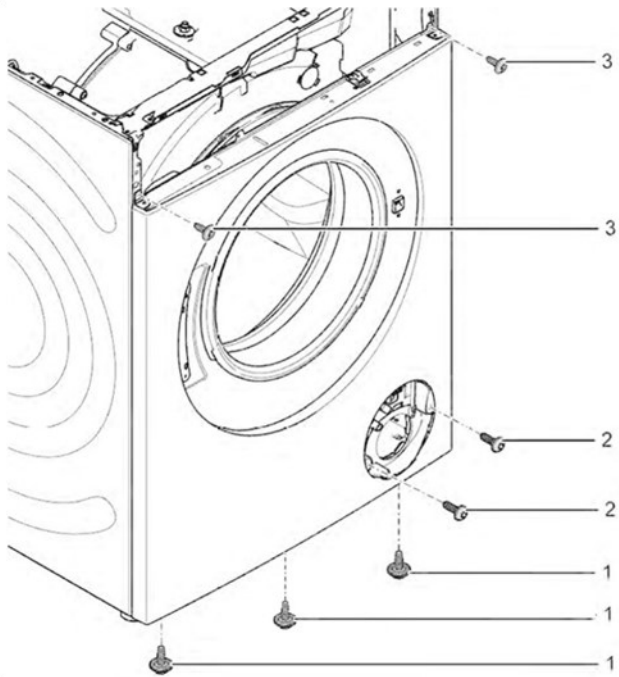

5. 1. Draai de schroeven aan de achterkant van het apparaat (1) los.
2. Verwijder het werkblad (2, 3).

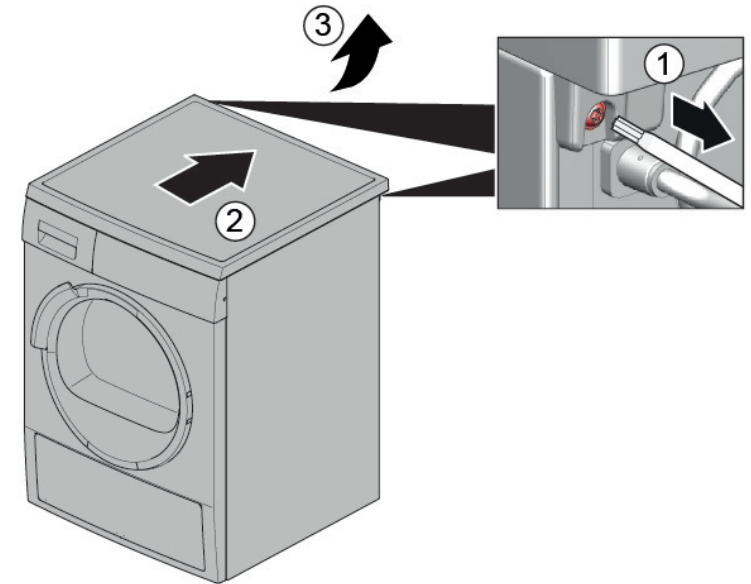

Reparatie

1. Verwijder schroeven (1).
2. Maak vergrendelelementen van het bedieningspaneel (2, 3) los.
3. Draai de schroeven in de behuizing van de wasmiddellade los.

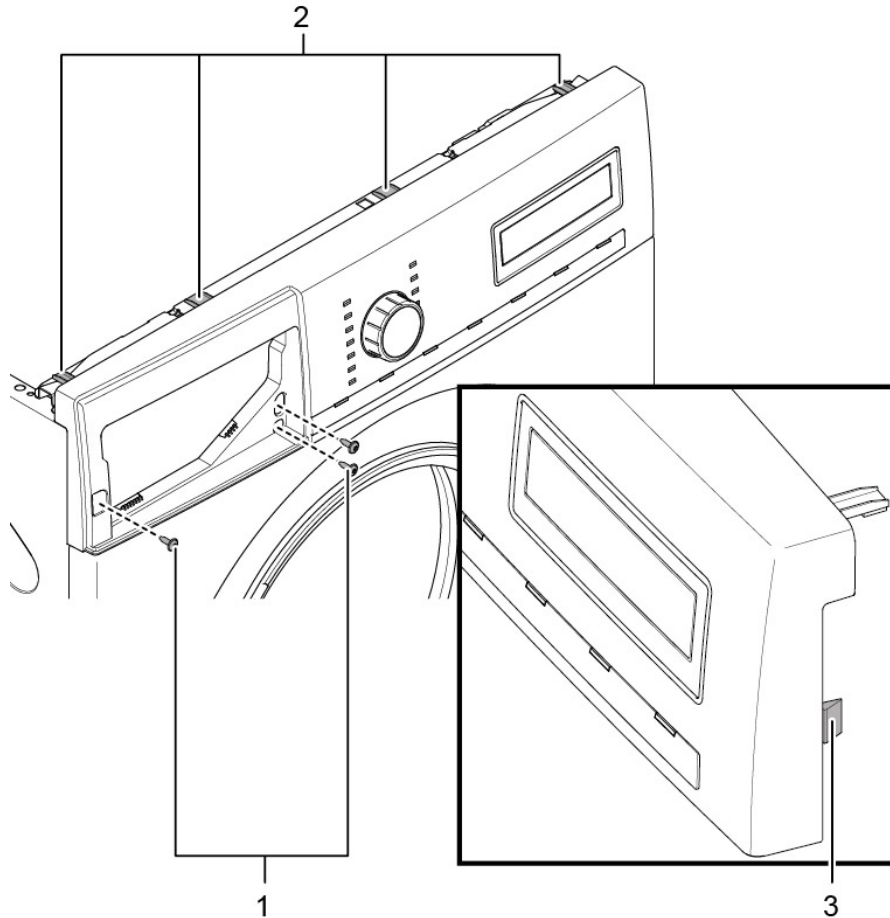

7. Verwijder het bedieningspaneel.

8. Verwijder de houder van de trommelverlichting bovenaan.

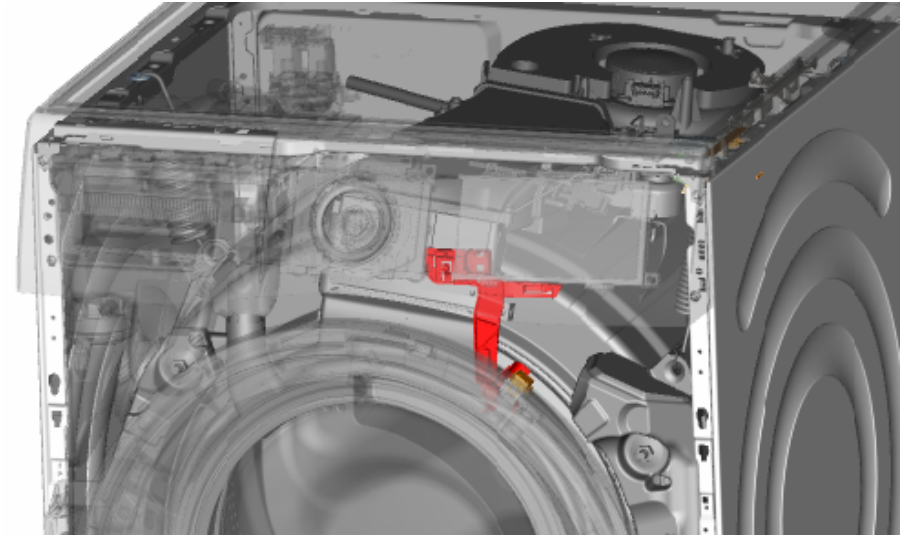

- 9.



LET OP!

Gevaar voor beschadigd oppervlak!

Het apparaatoppervlak kan krassen oplopen als verkeerde gereedschappen worden gebruikt.

- Gebruik uitsluitend kunststof gereedschappen om de spanning te vervangen.

Haal de spanning met een kunststof gereedschap van de afdichting af.

10. Haal de deurafdichting los van het frontpaneel.
11. Haal de kabelstekker los van het deurslot.

12. Draai de schroeven bovenaan het frontpaneel (3) los.

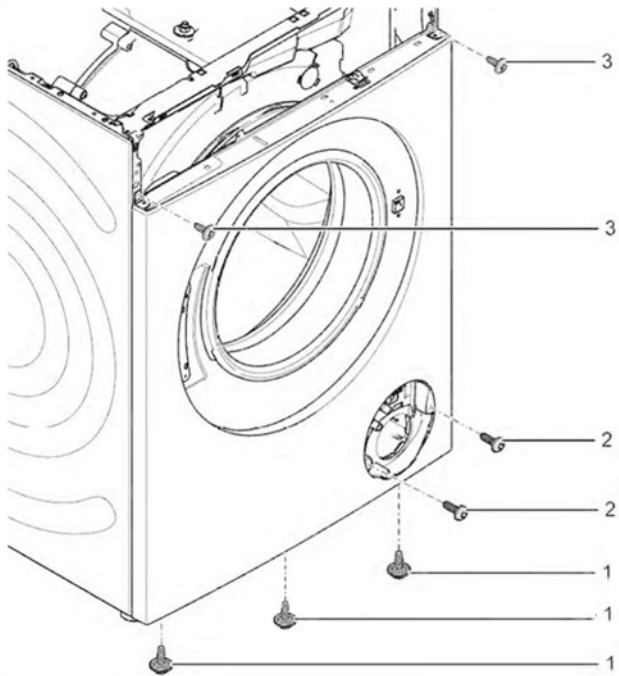

13. Verwijder het frontpaneel.

14. Maak alle slangverbindingen los.

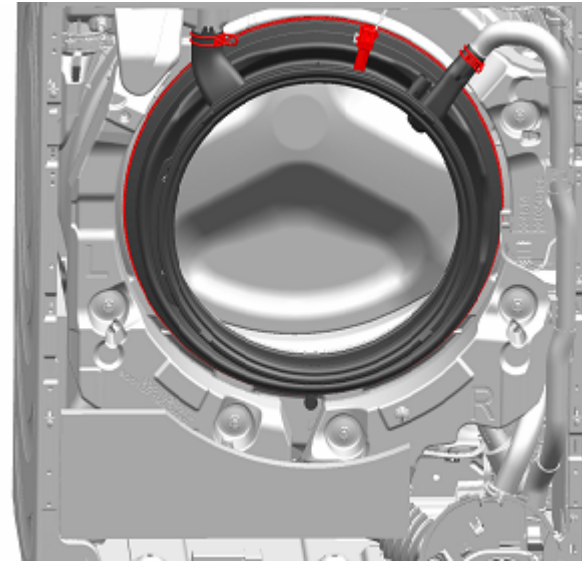

15. Verwijder de deurafdichting.

4.7.2 Deurafdichting monteren



WAARSCHUWING

Gevaar voor vallende onderdelen als gevolg van onjuiste installatie!
Persoonlijk letsel of materiële schade aan het apparaat.

► Haal de spanning van de rubber manchet aan met 3,4 Nm.

► Monteer in omgekeerde volgorde.

4.8 Deurslot vervangen

Als fabrikant zijn wij conform Verordening (EU) 2019/2023 verplicht om consumenten een reservedeurbeveiliging inclusief reparatie-instructies te verstrekken. Wij willen u er echter op wijzen dat na vervanging van een deurbeveiliging een elektrotechnische veiligheidstest door een gekwalificeerde elektricien vereist is voordat het apparaat in gebruik mag worden genomen. Deze persoon moet aantoonbaar gekwalificeerd zijn op grond van de landspecifieke wetten, regelgeving en normen.

	⚠ GEVAAR
	Gevaar voor een elektrische schok aan stroomvoerende onderdelen! Levensgevaar door elektrische schokken in geval van een ondeskundige reparatie <ul style="list-style-type: none">▶ Elektrische onderdelen moeten door gekwalificeerde elektriciens worden gerepareerd.▶ Laat na de reparatie een veiligheidstest conform VDE 0701 of de landspecifieke regelgeving uitvoeren.

	⚠ VOORZICHTIG
	Scherpe randen aan de behuizing! Snijletsel <ul style="list-style-type: none">▶ Draag veiligheidshandschoenen.

	⚠ WAARSCHUWING
	Weggliden van schuin staande apparaten! Botbreuken / beknellingsletsel <ul style="list-style-type: none">▶ Beveilig apparaten tegen wegglijden.

	⚠ VOORZICHTIG
	Gevaar voor vallende onderdelen als gevolg van losgeraakte schroeven! Letsel als gevolg van vallende onderdelen. <ul style="list-style-type: none">▶ Beveilig component tegen vallen.

	LET OP!
	Gevaar voor vallende onderdelen als gevolg van losgeraakte schroeven! Schade aan andere onderdelen van het apparaat of bij de klant thuis bijvoorbeeld aan de vloer. <ul style="list-style-type: none">▶ Beveilig component tegen vallen.

Voorwaarde:

- ✓ Apparaat wordt van de stroomvoorziening afgehaald.
- ✓ Apparaat wordt van de watervoorziening afgehaald.
- ✓ Het apparaat is vrij toegankelijk.
- ✓ [Werkblad is verwijderd. →95](#)
- ✓ Bedieningspaneel is verwijderd.
- ✓ [Deur is verwijderd. →99](#)
- ✓ Spanring is verwijderd.
- ✓ Frontpaneel is verwijderd.
- ✓ Deurafdichting is verwijderd.

4.8.1 Deurslot verwijderen

1. Haal de stekker van het deurslot los.
2. Maak het deurslot los.



3. Verwijder het deurslot.

4.8.2 Deurslot monteren

Het deurslot moet in de juiste positie worden bevestigd om te waarborgen dat de deuropeningsfunctie in geval van nood werkt.

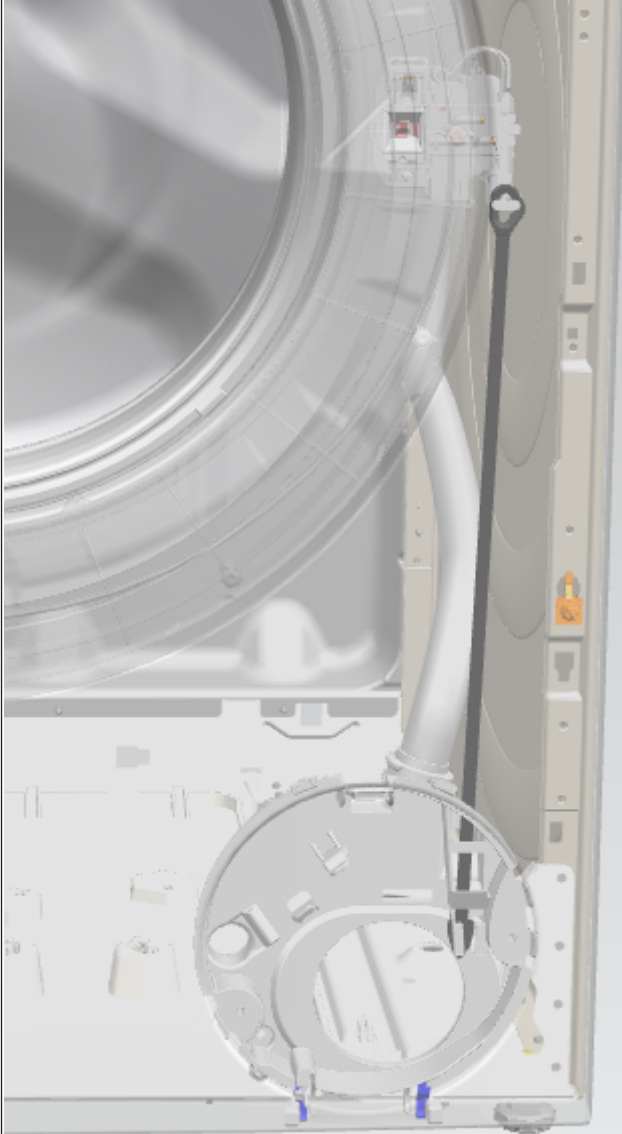

- ▶ Monteer in omgekeerde volgorde.

4.9 Trommelverlichting vervangen



⚠ VOORZICHTIG

Scherpe randen aan de behuizing!
Snijletsel
▶ Draag veiligheidshandschoenen.



⚠ WAARSCHUWING

Weggliden van schuin staande apparaten!
Botbreuken / beknellingsletsel
▶ Beveilig apparaten tegen wegglijden.



⚠ VOORZICHTIG

Gevaar voor vallende onderdelen als gevolg van losgeraakte schroeven!
Letsel als gevolg van vallende onderdelen.
▶ Beveilig component tegen vallen.



LET OP!

Gevaar voor vallende onderdelen als gevolg van losgeraakte schroeven!
Schade aan andere onderdelen van het apparaat of bij de klant thuis bijvoorbeeld aan de vloer.
▶ Beveilig component tegen vallen.

Voorwaarde:

- ✔ Apparaat wordt van de stroomvoorziening afgehaald.
- ✔ Apparaat wordt van de watervoorziening afgehaald.
- ✔ Het apparaat is vrij toegankelijk.
- ✔ [Werkblad is verwijderd.→95](#)
- ✔ [Wasmiddellade is verwijderd.→97](#)
- ✔ Bedieningspaneel is verwijderd.

4.9.1 Trommelverlichting verwijderen

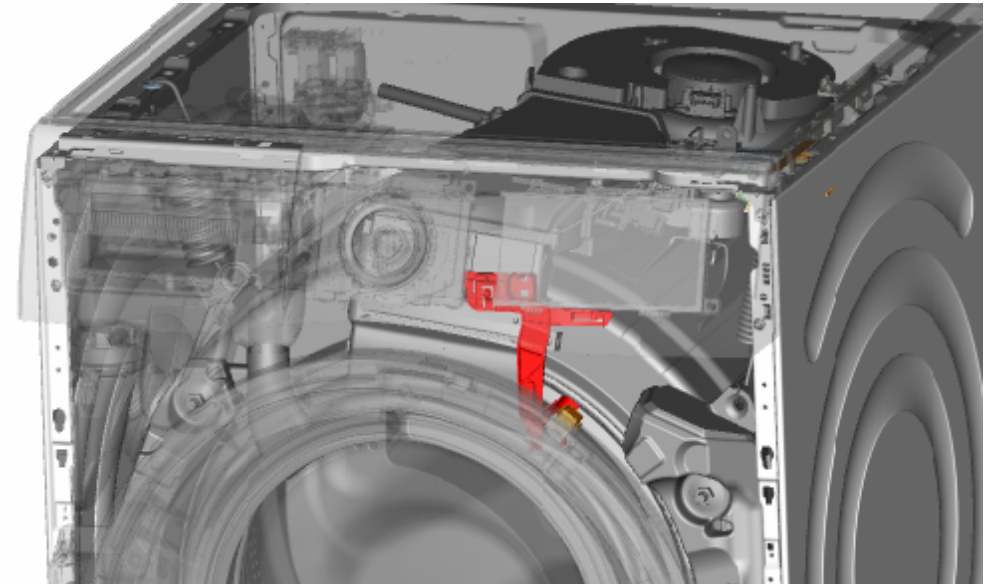

1. Trek de houder van de trommelverlichting uit het apparaat.
2. Haal de elektrische verbindingen los.
3. Haal de trommelverlichting uit de houder.

4.9.2 Trommelverlichting monteren

- ▶ Monteer in omgekeerde volgorde.

4.10 Pompdeksel vervangen

Voorwaarde:

- ✓ Apparaat wordt van de stroomvoorziening afgehaald.
- ✓ Apparaat wordt van de watervoorziening afgehaald.

4.10.1 Pompdeksel verwijderen

1. Open het pompdeksel.

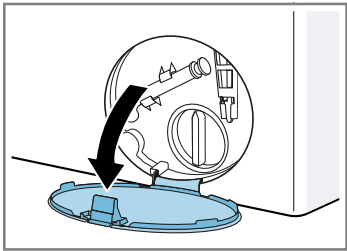

2. Verwijder het pompdeksel.

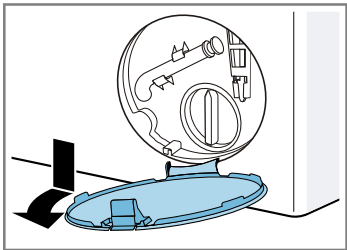

4.10.2 Pompdeksel monteren

- ▶ Monteer in omgekeerde volgorde.

4.11 Frontpaneel vervangen



⚠️ VOORZICHTIG

Scherpe randen aan de behuizing!

Snijletsel

- ▶ Draag veiligheidshandschoenen.

Voorwaarde:

- ✓ Apparaat wordt van de stroomvoorziening afgehaald.
- ✓ Apparaat wordt van de watervoorziening afgehaald.
- ✓ [Wasmiddellade is verwijderd. → 97](#)
- ✓ [Deur is verwijderd. → 99](#)
- ✓ Deurafdichting is verwijderd.
- ✓ [Pompdeksel is verwijderd. → 108](#)

4.11.1 Frontpaneel verwijderen

1.



⚠️ WAARSCHUWING

Weggliden van schuin staande apparaten!

Botbreuken / beknellingsletsel

- ▶ Beveilig apparaten tegen wegglijden.

Til het apparaat aan de voorkant op.

2. Verwijder de schroeven onderaan (1).

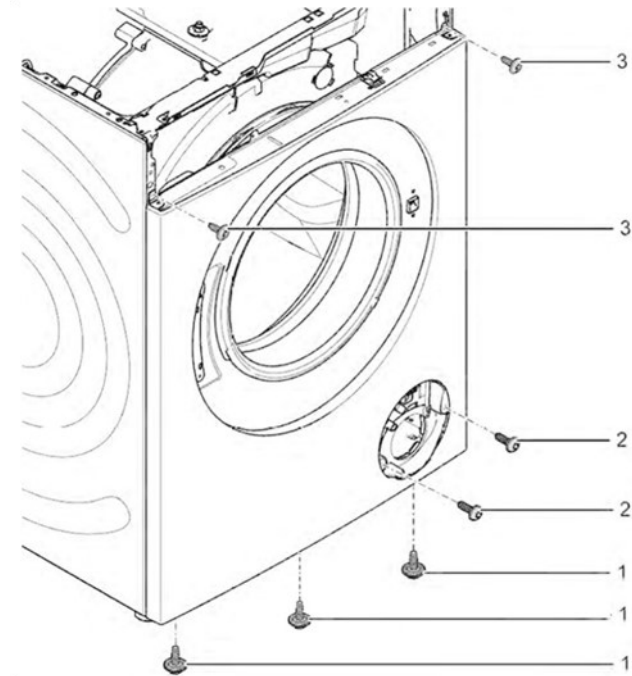

3. Laat het apparaat weer zakken.

Reparatie

1. Verwijder schroeven (1).
2. Duw het werkblad naar de achterkant van het apparaat (2).
3. Beweeg het werkblad omhoog (3) om het te verwijderen.

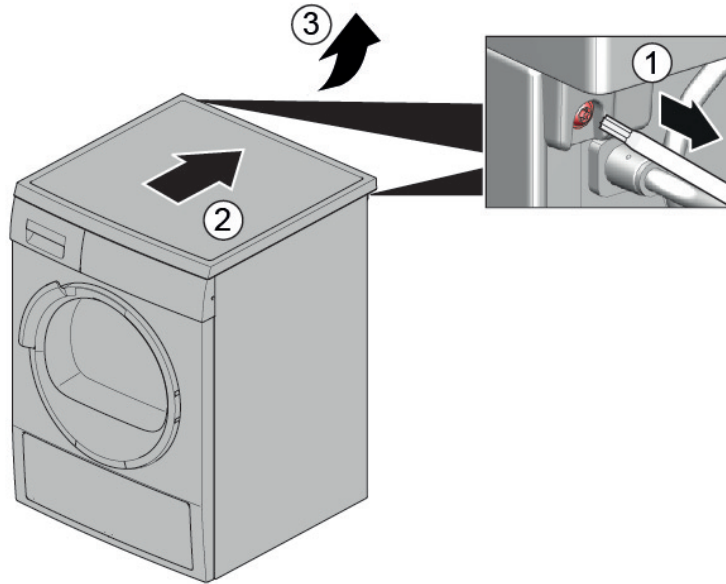

1. Verwijder schroeven (1).
2. Maak vergrendelelementen (2, 3) los.

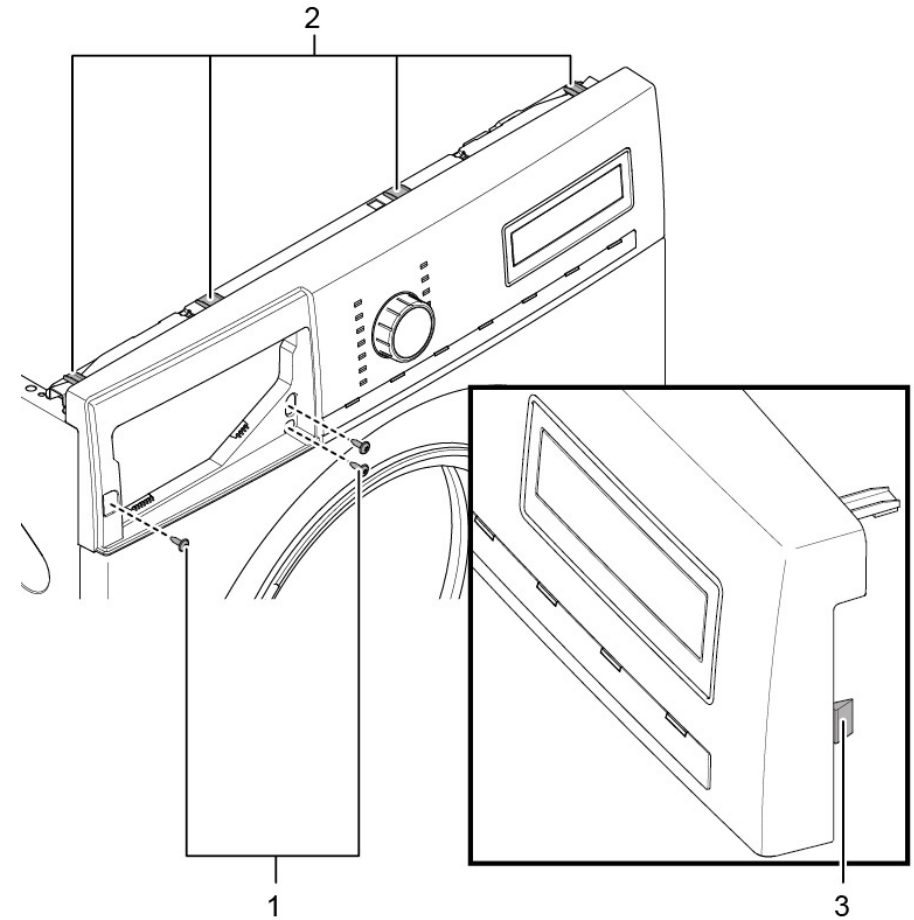

6. Verwijder het bedieningspaneel.

7.



⚠ VOORZICHTIG

Gevaar voor vallende onderdelen als gevolg van losgeraakte schroeven!

Letsel als gevolg van vallende onderdelen.

- Beveilig component tegen vallen.



LET OP!

Gevaar voor vallende onderdelen als gevolg van losgeraakte schroeven!

Schade aan andere onderdelen van het apparaat of bij de klant thuis bijvoorbeeld aan de vloer.

- ▶ Beveilig component tegen vallen.

Verwijder de schroeven aan de voorkant van beneden naar boven (2, 3).

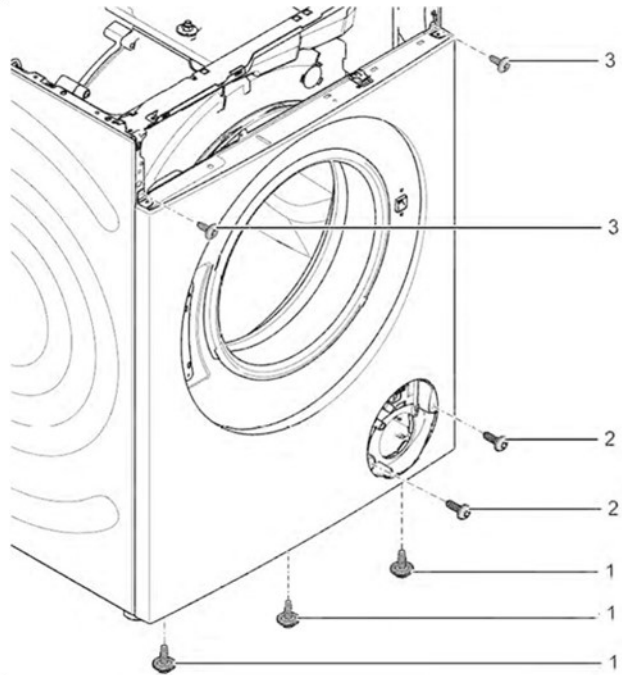





8. Verwijder het frontpaneel.

4.11.2 Frontpaneel monteren

- ▶ Monteer in omgekeerde volgorde.

Self-repair hints - Washing machine

 Concerning this document	113
1.1 Important information	113
1.1.1 Purpose.....	113
1.2 Explanation of symbols	113
1.2.1 Danger levels.....	113
1.2.2 Hazard symbols	113
1.2.3 Structure of the warnings.....	114
1.2.4 General symbols.....	114
 Safety	115
2.1 General Safety instructions	115
2.1.1 All domestic appliances	115
 Tools and aids	116
 Repair	117
4.1 Replacing worktop	117
4.1.1 Removing worktop	117
4.1.2 Installing worktop	117
4.2 Replacing fascia panel.....	118
4.2.1 Removing fascia panel	118
4.2.2 Installing fascia panel	118
4.3 Replacing detergent drawer	119
4.3.1 Removing detergent drawer.....	119
4.3.2 Installing detergent drawer.....	119
4.4 Replacing detergent drawer handle	120
4.4.1 Removing detergent drawer handle.....	120
4.4.2 Installing detergent drawer handle.....	120
4.5 Replacing door	121
4.5.1 Removing door	121
4.5.2 Installing door	121
4.6 Replacing door components.....	122
4.6.1 Removing door components	122
4.6.2 Installing door components	122
4.7 Replacing door seal.....	123
4.7.1 Removing door seal	123
4.7.2 Installing door seal	126

4.8 Replacing door lock.....	127
4.8.1 Removing door lock	127
4.8.2 Installing door lock.....	128
4.9 Replacing drum light	129
4.9.1 Removing drum light.....	129
4.9.2 Installing drum light.....	129
4.10 Replacing pump cover.....	130
4.10.1 Removing pump cover	130
4.10.2 Installing pump cover	130
4.11 Replacing front panel	131
4.11.1 Removing front panel.....	131
4.11.2 Installing front panel.....	133

i Concerning this document

1.1 Important information

1.1.1 Purpose

These repair hints support consumer to repair appliances by himself according to the applicable eco-design regulation (as of 03/2021).

They contain information how to exchange defined spare parts including warnings and risks.

In case of questions, please contact our customer service. We will only be liable for damages if the repair hints have been followed properly.

1.2 Explanation of symbols

1.2.1 Danger levels

The warning levels consist of a symbol and a signal word. The signal word indicates the severity of the danger.









Warning level	Meaning
	Non-observance of the warning message will result in death or serious injuries.
	Non-observance of the warning message could result in death or serious injuries.
	Non-observance of the warning message could result in minor injuries.
	Non-observance of the warning message could result in damage to property.

Table 1: Danger levels

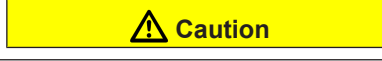
1.2.2 Hazard symbols

Hazard symbols are symbolic representations which give an indication of the kind of danger.

The following hazard symbols are used in this document:

Hazard symbol	Meaning
	General warning message
	Danger from electrical voltage
	Risk of explosion
	Danger of cuts
	Danger of crushing

i Concerning this document



Hazard symbol	Meaning
	Danger from hot surfaces
	Danger from strong magnetic field
	Danger from non-ionizing radiation

Table 2: Hazard symbols

1.2.3 Structure of the warnings

Warnings in this document have a standardised appearance and a standardised structure.



	<div style="background-color: red; color: white; padding: 2px; display: inline-block;"> Danger</div> Type and source of danger! Possible consequences of ignoring the danger / warning. ▶ Measures and prohibitions for preventing the danger.
--	--

The following example shows a warning that warns against electric shock due to live parts. The measure for avoiding the danger is mentioned.

	<div style="background-color: red; color: white; padding: 2px; display: inline-block;"> Danger</div> Risk of electric shock due to live parts! Death by electrocution ▶ Disconnect appliances from electrical supply at least 60 seconds before starting repairs.
---	--

1.2.4 General symbols

The following general symbols are used in this document:

Gen. symbol	Meaning
	Identification of a special tip (text and/or graphic)
	Identification of a simple tip (only text)
	Identification of a link to a video tutorial





Gen. symbol	Meaning
	Identification of required tools
	Identification of required preconditions
	Identification of a condition (if ..., then ...)
	Identification of a result
[Start]	Identification of a key or button
[00123456]	Identification of a material number
Status	Identification of displayed text / window (in the appliance's display)

Table 3: General symbols

2.1 General Safety instructions

2.1.1 All domestic appliances

Risk of electric shock due to live parts!

- Errors by repairs involving electrical components can lead to electrical shock!
- Disconnect the appliance from the mains for at least 60 seconds before starting work.
- After the repair have a safety test according VDE 0701 or country-specific regulations performed.

Risk of injury from sharp edges!

- Wear protective gloves.

Risk of crushing during repair, maintenance, troubleshooting and service due to heavy and moving components

- Wear protective shoes.
- Secure heavy components from falling down.
- Do not stick body parts into moving components.







Risk to the appliance's safety / function!





- Only use original spare parts.

Risk of damage to electrostatically sensitive components (ESDs)!

- Do not touch the modules, including connections and conductor paths.

Tools and aids

Designation	Details	Images
Auxiliary tool [15000155]	Tool for loosening out of plastic parts	
Screwdriver Torx T20 with bore hole [00340764]	100 mm, for screws with safety pin	
Torque spanner [15000441]	Torque spanner 20 - 100 Nm	
Slot screwdriver [00340854]	Blade 3.5 mm x 0.6 mm x 100 mm, Protective Insulation 1000 V AC	
Slot screwdriver [00340855]	Blade 5.5 mm x 1.0 mm x 125 mm, Protective Insulation 1000 V AC	
Needle-nose pliers, angled pattern [00341269]	Length 200 mm	
Side-cutting pliers [00342182]	Length: 200 mm	



Designation	Details	Images
Combination wrench [00340811]	Wrench size 10°mm, M6	
Combination wrench [00340814]	Wrench size 13°mm, M8	
Combination wrench [00340817]	Wrench size 17 mm, M10	
Combination wrench [15000459]	Wrench size 16°mm, M10	

4.1 Replacing worktop

Required tools:

-  Torx Bit TX20 with hole, long 6.3°mm (1/4") 152°mm, for screws [00341272] with safety pin

Prerequisite:

-  Appliance is disconnected from power supply.
-  Appliance is disconnected from water supply.

4.1.1 Removing worktop

- ▶ 1. Remove screws (1).
- ▶ 2. Push worktop to the back of the appliance (2).
- ▶ 3. Move worktop upwards (3) to remove it.

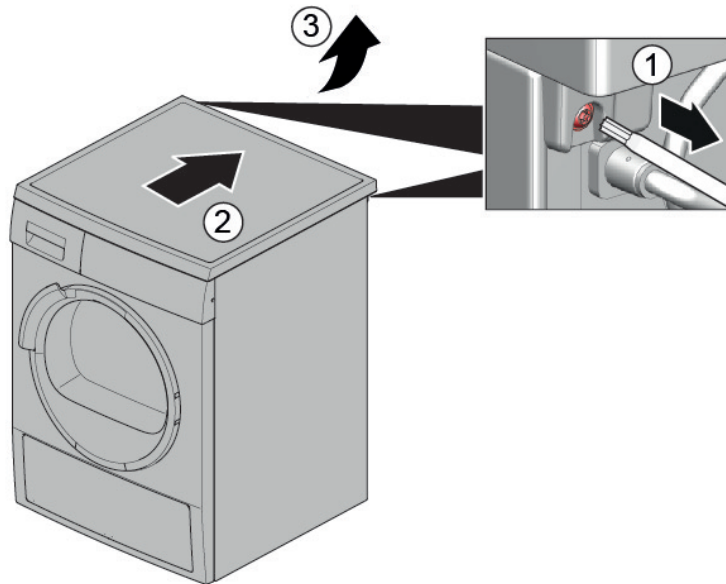

4.1.2 Installing worktop

- ▶ Install in reverse order.

4.2 Replacing fascia panel



Caution

Sharp housing edges!
Cut injuries
▶ Wear protective gloves.



Warning

Slipping of tilted appliances!
Bone fractures / crush injuries
▶ Secure appliances against slipping.



Caution

Risk of falling parts due to released screws!
Injury because of falling parts.
▶ Secure component from falling down.



Notice

Risk of falling parts due to released screws!
Damage to other parts of the appliance or at customers home e.g. bottom.
▶ Secure component from falling down.

Prerequisite:

- ✓ Appliance is disconnected from power supply.
- ✓ Appliance is disconnected from water supply.
- ✓ [Worktop has been removed. → Page 117](#)
- ✓ [Detergent drawer has been removed. → Page 119](#)

4.2.1 Removing fascia panel

1. 1. Remove screws (1).
2. 2. Release catch elements (2, 3).

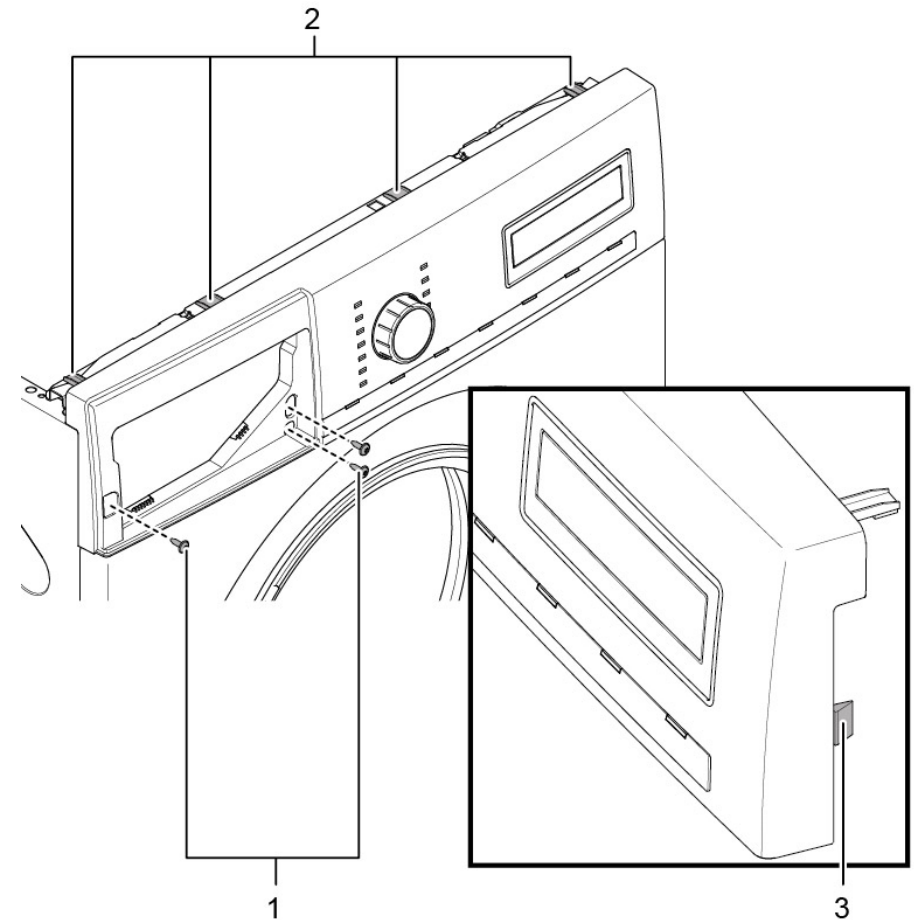

2. 2. Release plug contact of control unit.
3. 3. Remove fascia panel.

4.2.2 Installing fascia panel

- ▶ Install in reverse order.

4.3 Replacing detergent drawer

Prerequisite:

- ✓ Appliance is disconnected from power supply.
- ✓ Appliance is disconnected from water supply.

4.3.1 Removing detergent drawer

1. Pull out detergent drawer.
2.
 1. Press down on insert (1).
 2. Remove detergent drawer (2).

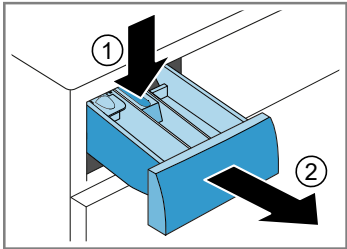

4.3.2 Installing detergent drawer

- ▶ Install in reverse order.

4.4 Replacing detergent drawer handle

Prerequisite:

- ✓ Appliance is disconnected from power supply.
- ✓ Appliance is disconnected from water supply.
- ✓ [Detergent drawer has been removed.](#) → [Page 119](#)

4.4.1 Removing detergent drawer handle

1. Release catch elements.

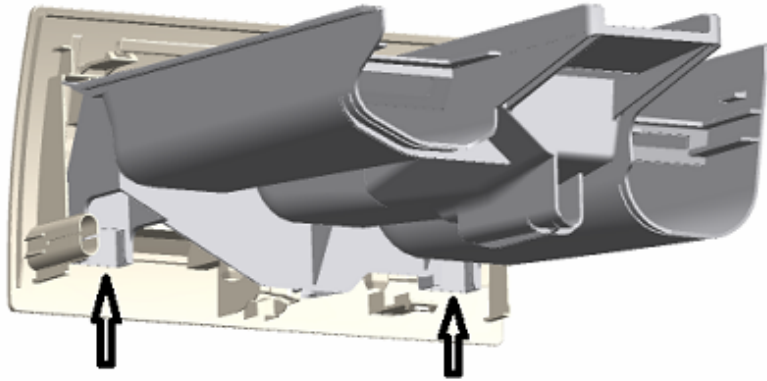

2. Remove detergent drawer handle.

4.4.2 Installing detergent drawer handle

- ▶ Install in reverse order.

4.5 Replacing door

	⚠ Caution Open hinge area! Finger crushing / entrapment <ul style="list-style-type: none">▶ Do not reach into the hinge area.▶ Wear protective gloves.
--	---

Prerequisite:

- ✔ Appliance is disconnected from power supply.
- ✔ Appliance is disconnected from water supply.
- ✔ Door is opened.

4.5.1 Removing door

1.

	Notice Risk of falling parts due to released screws! Damage to other parts of the appliance or at customers home e.g. bottom. <ul style="list-style-type: none">▶ Secure component from falling down.
---	---

	⚠ Caution Risk of falling parts due to released screws! Injury because of falling parts. <ul style="list-style-type: none">▶ Secure component from falling down.
---	--

Remove screws (1).

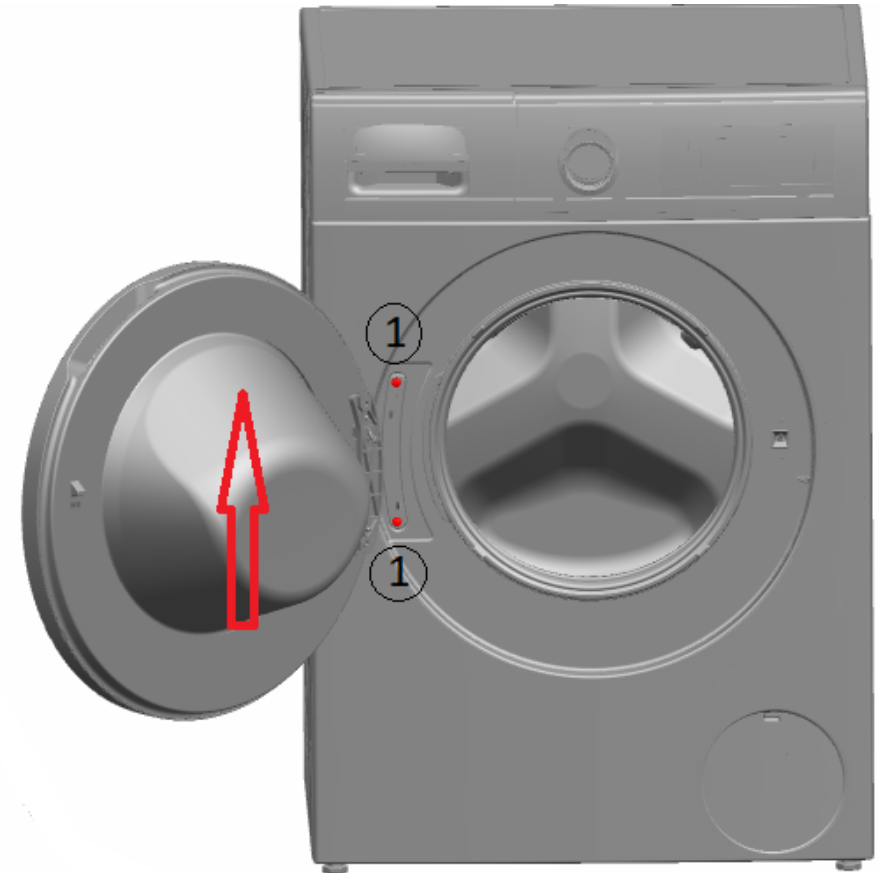

2. Remove door upwards.

4.5.2 Installing door

- ▶ Install in reverse order.

4.6 Replacing door components



Caution

Open hinge area!

Finger crushing / entrapment

- ▶ Do not reach into the hinge area.
- ▶ Wear protective gloves.

Prerequisite:

- ✓ Appliance is disconnected from power supply.
- ✓ Appliance is disconnected from water supply.
- ✓ [Door has been removed.](#) → [Page 121](#)

4.6.1 Removing door components

- ▶ Disassemble door from outside to inside.

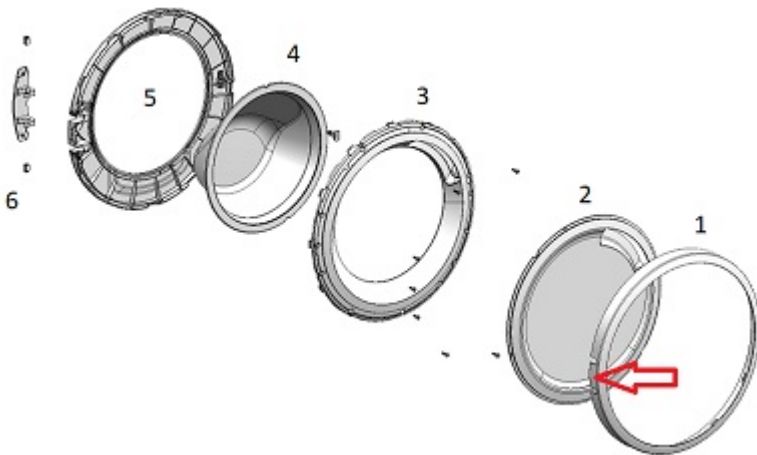



4.6.2 Installing door components

- ▶ Install in reverse order.

4.7 Replacing door seal

	⚠ Caution
	Sharp housing edges! Cut injuries ▶ Wear protective gloves.

	⚠ Caution
	Risk of falling parts due to released screws! Injury because of falling parts. ▶ Secure component from falling down.

	Notice
	Risk of falling parts due to released screws! Damage to other parts of the appliance or at customers home e.g. bottom. ▶ Secure component from falling down.

Prerequisite:

- ✓ Appliance is disconnected from power supply.
- ✓ Appliance is disconnected from water supply.
- ✓ [Detergent drawer has been removed.→ Page 119](#)
- ✓ [Door has been removed.→ Page 121](#)
- ✓ [Pump cover has been removed.→ Page 130](#)

4.7.1 Removing door seal

	⚠ Warning
	Slipping of tilted appliances! Bone fractures / crush injuries ▶ Secure appliances against slipping.

Lift up appliance at front.

2. Release screws at bottom of front panel (1).

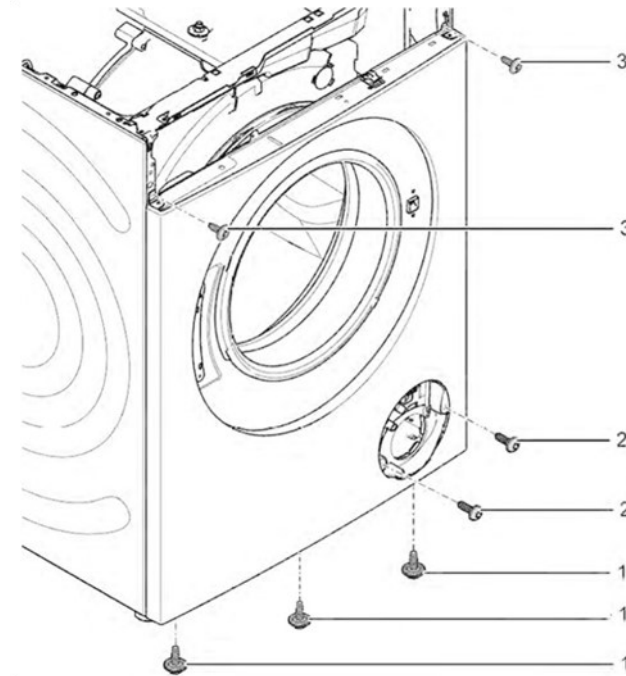

3. Lower appliance down.

Repair

4. Remove screws in pump area (2).

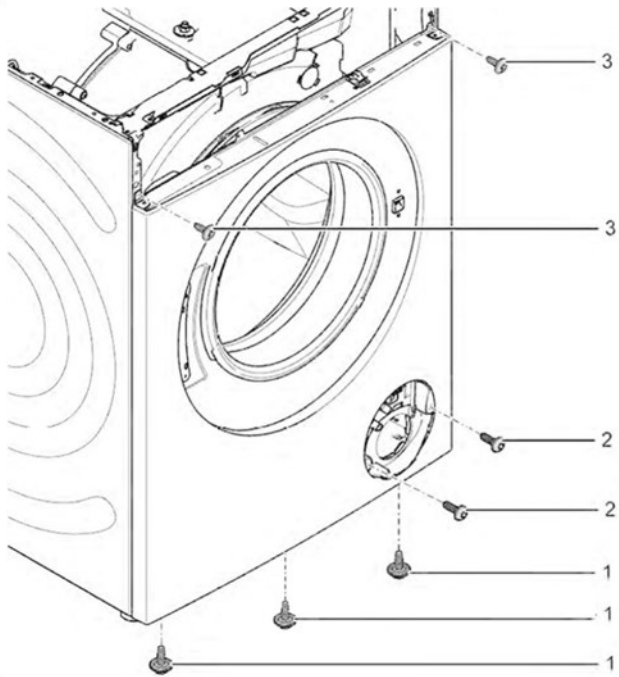

5. 1. Release screws at back of appliance (1).
2. Remove worktop (2, 3).

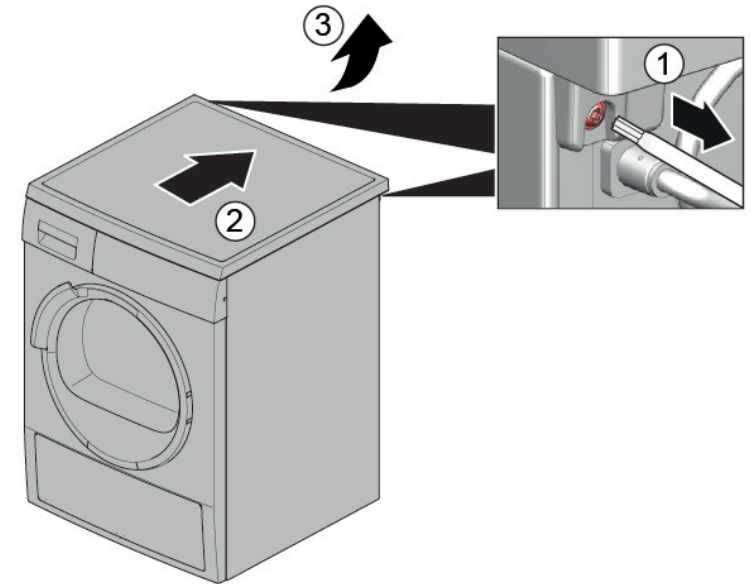

6. 1. Remove screws (1).
2. Release cat elements of fascia panel (2, 3).
3. Release screws of dispenser housing.

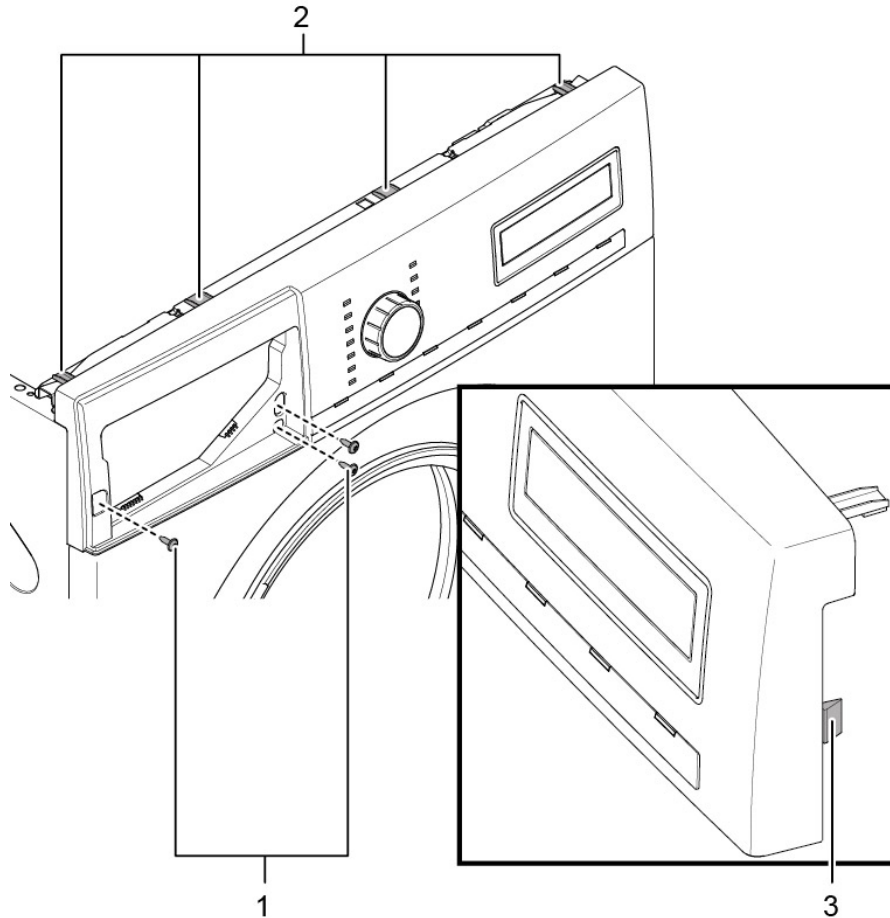

7. Remove fascia panel.

8. Remove drum light holder at top.

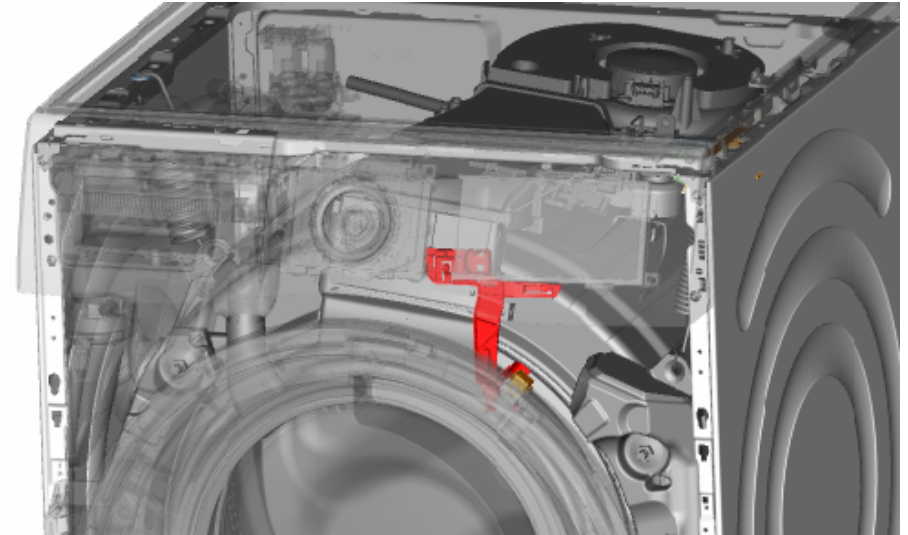

- 9.



Notice

Risk of damaged surface!

Surface of appliance can be scratched by using wrong tools.
▶ Only use plastic tools to replace the tension ring.

Remove tension ring from gasket with a plastic tool.

10. Release door seal from front panel.
11. Release cable connector from door lock.

12. Release screws on top of front panel (3).

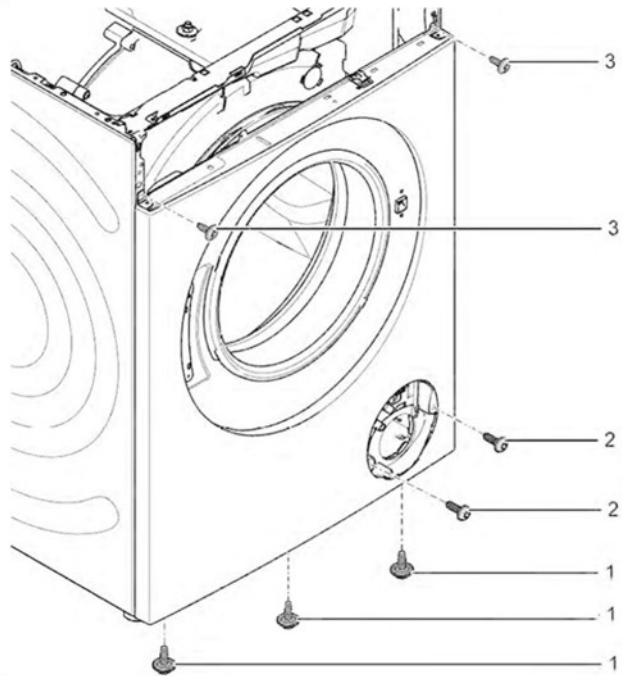

13. Remove front panel.

14. Release all hose connections.

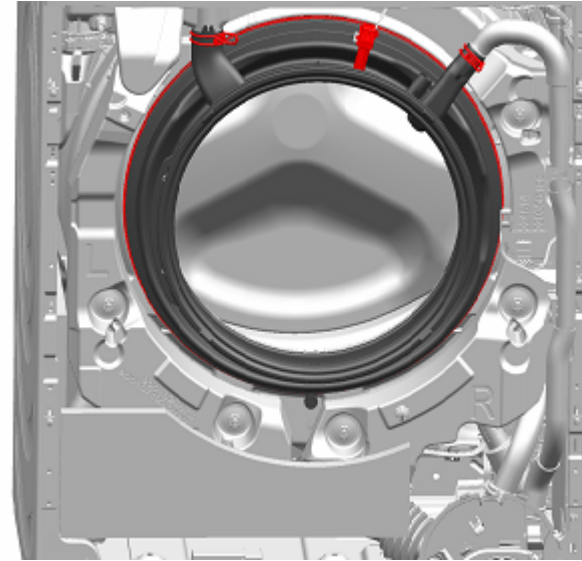

15. Remove door seal.

4.7.2 Installing door seal



Warning

Risk of falling parts due to incorrect installation!





Injury or damage to the appliance.

- ▶ Tighten tension ring of boot gasket with 3,4 Nm.

- ▶ Install in reverse order.

4.8 Replacing door lock

As a manufacturer, we are obliged to provide consumers with the spare part door lock including repair instructions in accordance with Regulation (EU) 2019/2023. However, we would like to point out that after replacing a door lock, an electrotechnical safety test by a qualified electrician is required before the device is put into operation. This person must be verifiably qualified according to the country-specific laws, regulations and standards.

	Danger Risk of electric shock due to live parts! Danger to life through electric shock in case of improper repair <ul style="list-style-type: none">▶ Electric parts should be repaired by a qualified electricians.▶ After the repair have a safety test according VDE 0701 or country-specific regulations performed.
	Caution Sharp housing edges! Cut injuries <ul style="list-style-type: none">▶ Wear protective gloves.
	Warning Slipping of tilted appliances! Bone fractures / crush injuries <ul style="list-style-type: none">▶ Secure appliances against slipping.
	Caution Risk of falling parts due to released screws! Injury because of falling parts. <ul style="list-style-type: none">▶ Secure component from falling down.
	Notice Risk of falling parts due to released screws! Damage to other parts of the appliance or at customers home e.g. bottom. <ul style="list-style-type: none">▶ Secure component from falling down.

Prerequisite:

- ✓ Appliance is disconnected from power supply.
- ✓ Appliance is disconnected from water supply.

- ✓ Appliances is freely accessible.
- ✓ [Worktop has been removed.→ Page 117](#)
- ✓ Fascia panel has been removed.
- ✓ [Door has been removed.→ Page 121](#)
- ✓ Tension ring has been removed.
- ✓ Front panel has been removed.
- ✓ Door seal has been removed.

4.8.1 Removing door lock

1. Disconnect door lock plug.
2. Release door lock.



3. Remove door lock.

4.8.2 Installing door lock

Door lock must be in the right position to ensure the emergency door opening function of the appliance.

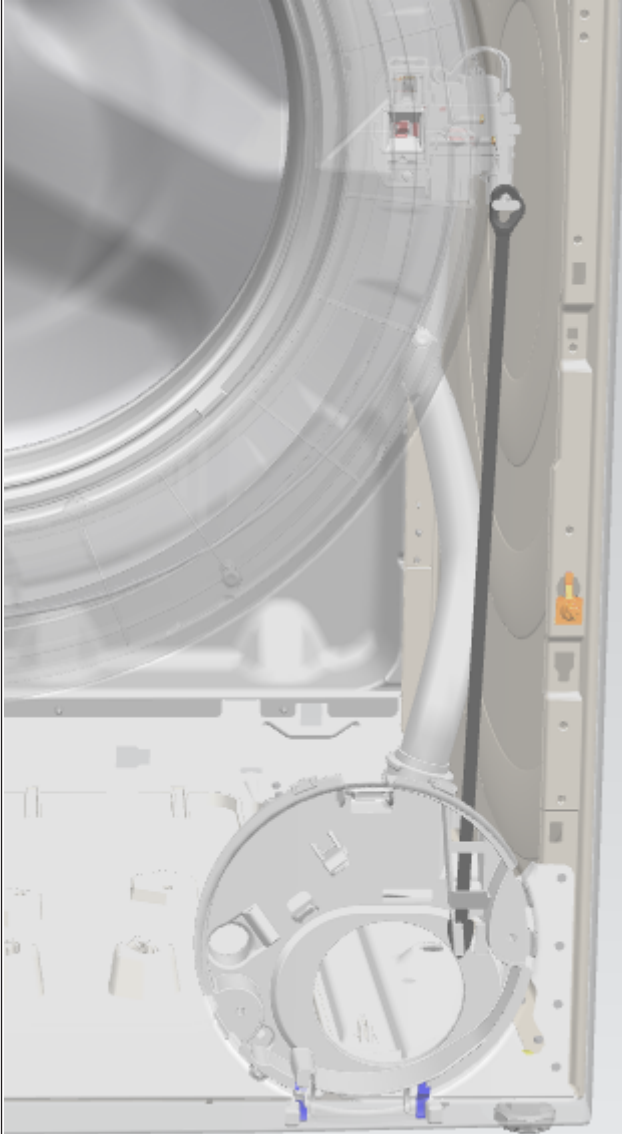

- ▶ Install in reverse order.

4.9 Replacing drum light



Caution

Sharp housing edges!
Cut injuries
▶ Wear protective gloves.



Warning

Slipping of tilted appliances!
Bone fractures / crush injuries
▶ Secure appliances against slipping.



Caution

Risk of falling parts due to released screws!
Injury because of falling parts.
▶ Secure component from falling down.



Notice

Risk of falling parts due to released screws!
Damage to other parts of the appliance or at customers home e.g. bottom.
▶ Secure component from falling down.

Prerequisite:

- ✔ Appliance is disconnected from power supply.
- ✔ Appliance is disconnected from water supply.
- ✔ Appliances is freely accessible.
- ✔ [Worktop has been removed.→ Page 117](#)
- ✔ [Detergent drawer has been removed.→ Page 119](#)
- ✔ Fascia panel has been removed.

4.9.1 Removing drum light

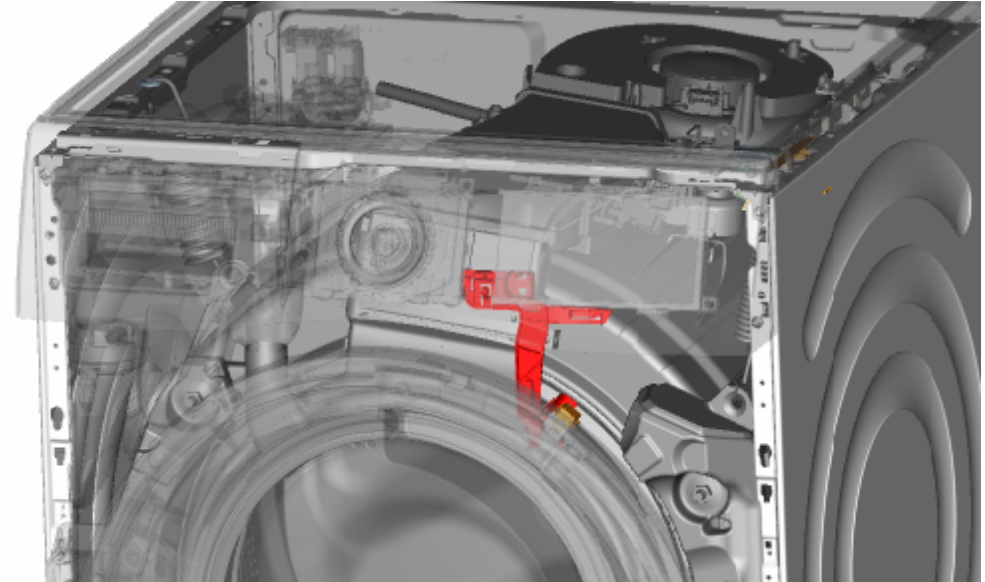

1. Pull drum light holder out of appliance.
2. Disconnect electrical connections.
3. Remove drum light from drum light holder.

4.9.2 Installing drum light

- ▶ Install in reverse order.

4.10 Replacing pump cover

Prerequisite:

- ✔ Appliance is disconnected from power supply.
- ✔ Appliance is disconnected from water supply.

4.10.1 Removing pump cover

1. Open pump cover.

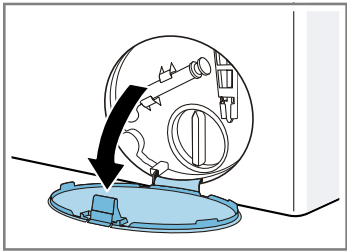

2. Remove pump cover.

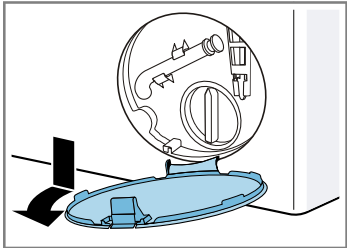

4.10.2 Installing pump cover

- ▶ Install in reverse order.

4.11 Replacing front panel



Caution

Sharp housing edges!

Cut injuries

- ▶ Wear protective gloves.

Prerequisite:

- ✓ Appliance is disconnected from power supply.
- ✓ Appliance is disconnected from water supply.
- ✓ [Detergent drawer has been removed.→ Page 119](#)
- ✓ [Door has been removed.→ Page 121](#)
- ✓ Door seal has been removed.
- ✓ [Pump cover has been removed.→ Page 130](#)

4.11.1 Removing front panel

1.



Warning

Slipping of tilted appliances!

Bone fractures / crush injuries

- ▶ Secure appliances against slipping.

Lift up appliance at front.

2. Remove screws at bottom (1).

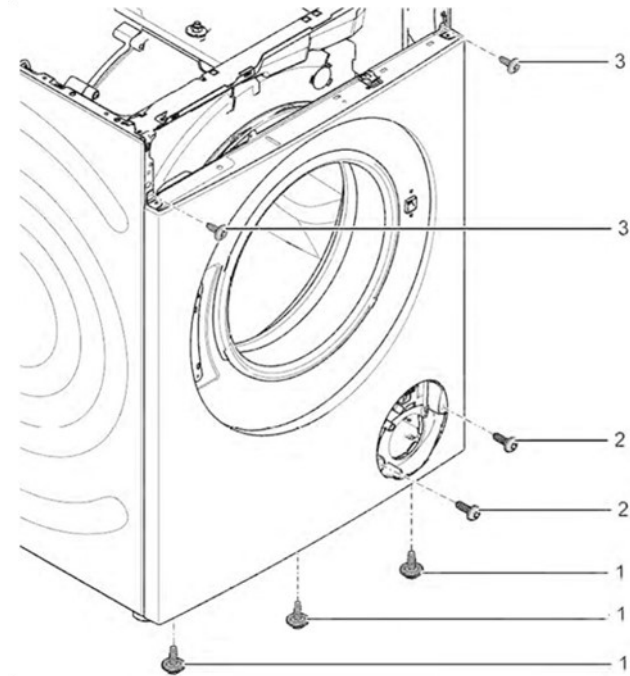

3. Lower appliance down.

Repair

4. 1. Remove screws (1).
2. Push worktop to the back of the appliance (2).
3. Move worktop upwards (3) to remove it.

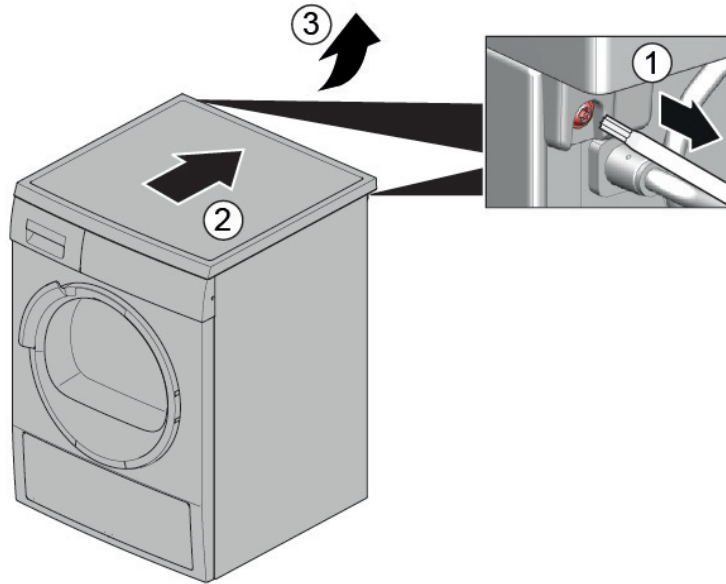

5. 1. Remove screws (1).
2. Release catch elements (2, 3).

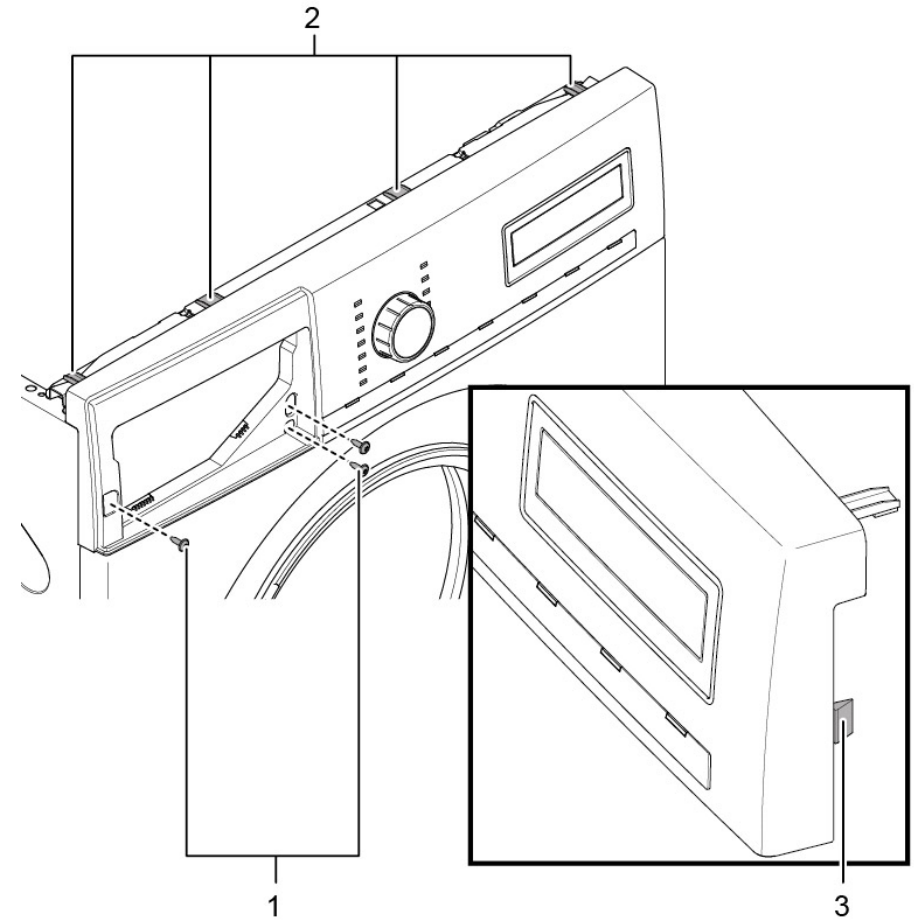

6. Remove fascia panel.

7.



 **Caution**

Risk of falling parts due to released screws!
Injury because of falling parts.
▶ Secure component from falling down.



Notice

Risk of falling parts due to released screws!

Damage to other parts of the appliance or at customers home e.g. bottom.

- ▶ Secure component from falling down.

Remove screws at front beginning from bottom to top (2, 3).

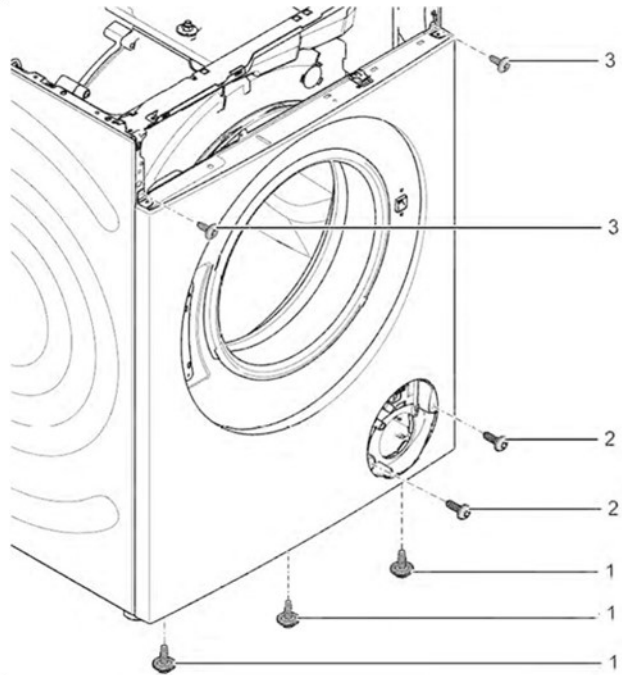

8. Remove front panel.

4.11.2 Installing front panel

- ▶ Install in reverse order.

Remonditeave - Pesumasin

 Selle dokumendiga seoses	135
1.1 Tähtis teave	135
1.1.1 Eesmärk.....	135
1.2 Sümbolite selgitus	135
1.2.1 Ohutasemed.....	135
1.2.2 Ohusümbolid	135
1.2.3 Hoiatuste struktuur.....	136
1.2.4 Üldised sümbolid.....	136
 Ohutus.....	137
2.1 Üldised ohutusjuhised.....	137
2.1.1 Kõik kodumasinad.....	137
 Tööriistad ja abinõud.....	138
 Remont.....	139
4.1 Tööpinna vahetamine	139
4.1.1 Tööpinna eemaldamine	139
4.1.2 Tööpinna paigaldamine	139
4.2 Välispaneeli vahetamine	140
4.2.1 Välispaneeli eemaldamine	140
4.2.2 Välispaneeli paigaldamine	140
4.3 Pesuaine sahtli vahetamine.....	141
4.3.1 Pesuaine sahtli eemaldamine	141
4.3.2 Pesuaine sahtli paigaldamine	141
4.4 Pesuaine sahtli käepideme vahetamine	142
4.4.1 Pesuaine sahtli käepideme eemaldamine	142
4.4.2 Pesuaine sahtli käepideme paigaldamine	142
4.5 Ukse vahetamine.....	143
4.5.1 Ukse eemaldamine	143
4.5.2 Ukse paigaldamine.....	143
4.6 Ukseosade vahetamine.....	144
4.6.1 Ukse osade eemaldamine	144
4.6.2 Ukse osade paigaldamine	144
4.7 Ukse tihendi vahetamine.....	145
4.7.1 Ukse tihendi eemaldamine.....	145
4.7.2 Uksetihendi paigaldamine.....	148

4.8 Ukseluku vahetamine	149
4.8.1 Ukseluku eemaldamine.....	149
4.8.2 Ukseluku paigaldamine	150
4.9 Trumli valgustuse vahetamine.....	151
4.9.1 Trumli valgustuse eemaldamine	151
4.9.2 Trumli valgustuse paigaldamine	151
4.10 Pumba katte vahetamine	152
4.10.1 Pumba katte eemaldamine.....	152
4.10.2 Pumba katte paigaldamine.....	152
4.11 Esipaneeli vahetamine	153
4.11.1 Esipaneeli eemaldamine	153
4.11.2 Esipaneeli paigaldamine	155

i Selle dokumendiga seoses

1.1 Tähtis teave

1.1.1 Eesmärk

Need remondinõuanded toetavad tarbijat seadmete iseseisval remontimisel vastavalt kehtivale ökodisaini määrusele (03/2021).





Need sisaldavad teavet selle kohta, kuidas vahetada teatud varuosi, samuti hoiatusi ning ohtusid.

Küsimuste korral võtke ühendust meie klienditeenindusega. Meie vastutame kahjustuste eest ainult siis, kui remondinõuandeid on õigesti järgitud.

1.2 Sümbolite selgitus

1.2.1 Ohutasemed

Ohutasemed koosnevad sümbolist ja märksõnast. Märksõna viitab ohu raskusastmele.

Hoiatustase	Tähendus
 OHT	Hoiatusteadete eiramine põhjustab surma või raskeid kehavigastusi.
 HOIATUS	Hoiatusteadete eiramine võib põhjustada surma või raskeid kehavigastusi.
 ETTEVAATUST!	Hoiatusteadete eiramine võib põhjustada kergeid kehavigastusi.
 TÄHELEPANU!	Hoiatusteadete eiramine võib põhjustada varakahju.

Tabel 1: Ohutasemed



1.2.2 Ohusümbolid

Ohusümbolid on sümboolsed kujutised, mis viitavad ohu laadile.

Selles dokumendis kasutatakse alljärgnevaid ohusümboleid.

Ohusümbol	Tähendus
	Üldine ohuteade
	Elektripingest tingitud oht
	Plahvatusoht
	Lõikeoht
	Muljumisoht

i Selle dokumendiga seoses

Ohusümbol	Tähendus
	Kuumadest pindadest tingitud oht
	Tugevast magnetväljast tingitud oht
	Mitteioniseerivast kiirgusest tingitud oht

Tabel 2: Ohusümbolid

1.2.3 Hoiatuste struktuur

Selles dokumendis olevatel hoiatustel on standardiseeritud väljanägemine ja standardiseeritud struktuur.



	<div style="background-color: red; color: white; padding: 2px; display: inline-block;">⚠ OHT</div> Ohu tüüp ja allikas! Ohu/hoiatuse eiramise võimalikud tagajärjed. ▶ Meetmed ja ettevaatusabinõud ohu vältimiseks.
--	---





Alljärgnevas näiteks on näidatud hoiatust, millega hoiatatakse liikuvatest osadest tingitud elektrilöögiu eest. Nimetatud on meetet ohu vältimiseks.

	<div style="background-color: red; color: white; padding: 2px; display: inline-block;">⚠ OHT</div> Liikuvatest osadest tingitud elektrilöögi oht! Elektrilöögist tingitud surm ▶ Enne remonditöödega alustamist ühendage seadmed elektrivõrgust lahti vähemalt 60 sekundit varem.
---	--

1.2.4 Üldised sümbolid

Selles dokumendis kasutatakse alljärgnevaid üldisi sümboleid.

Üld. sümbol	Tähendus
	Erinõuande tunnus (tekst ja/või graafik)
	Lihtsa nõuande tunnus (ainult tekst)
	Videojuhendi lingi tunnus

Üld. sümbol	Tähendus
	Vajalike tööriistade tunnus
	Vajalike eeltingimuste tunnus
	Seisukorra tunnus (kui..., siis...)
	Tulemuse tunnus
[Start]	Klahvi või nupu tunnus
[00123456]	Materjalinumbr tunnus
Olek	Kuvatava teksti/akna tunnus (seadme ekraanil)

Tabel 3: Üldised sümbolid

2.1 Üldised ohutusjuhised

2.1.1 Kõik kodumasinad

Liikuvatest osadest tingitud elektrilöögi oht!

- Elektriliste osade remondil tehtud vead võivad põhjustada elektrilööki!
- Lahutage seade vooluvõrgust vähemalt 60 sekundit enne tööle hakkamist.
- Pärast remonti peab olema tehtud ohutuskatse vastavalt standardile VDE 0701 või riiklikele määrustele.

Teravatest servadest tingitud vigastusoht!

- Kandke kaitsekindaid.

Rasketest ja liikuvatest osadest tingitud muljumisoht remondi-, puhastustööde, tõrkeotsingu ja hoolduse käigus

- Kandke turvakingi.
- Kinnitage rasked osad allakukkumise vastu.
- Ärge toppige kehaosi liikuvate osade vahele.







Oht seadme ohutusele/talitlusele!





- Kasutage ainult originaalvaruosasid.

Elektrostaatiliselt tundlike osade (ESD) kahjustamise oht!

- Ärge puudutage moduleid, kaasa arvatud ühendusi ega transportöörlinte.

Tööriistad ja abinõud

Määramine	Üksikasjad	Kujutised
Abitööriist [15000155]	Tööriist plastosade lahtitegemiseks	
Tähtotsikuga T20 kruvikeeraja koos puurimisaguga [00340764]	100 mm, splindiga poltidele	
Pöördemomendi mutrivõti [15000441]	Pöördemomendi mutrivõti 20-100 Nm	
Lapik kruvikeeraja [00340854]	Tera 3,5 mm x 0,6 mm x 100 mm, kaitseisolatsioon 1000 V AC	
Lapik kruvikeeraja [00340855]	Tera 5,5 mm x 1,0 mm x 125 mm, kaitseisolatsioon 1000 V AC	
Peeneotsalsed tangid, nurga all [00341269]	Pikkus 200 mm	
Külg-lõiketangid [00342182]	Pikkus: 200 mm	

Määramine	Üksikasjad	Kujutised
Kombineeritud mutrivõti [00340811]	Mutrivõtme suurus 10°mm, M6	
Combination wrench [00340814]	Mutrivõtme suurus 13°mm, M8	
Kombineeritud mutrivõti [00340817]	Mutrivõtme suurus 17 mm, M10	
Kombineeritud mutrivõti [15000459]	Mutrivõtme suurus 16°mm, M10	

4.1 Tööpinna vahetamine

Eritööriistad:

- 🌀 Pikk, auguga tähtotsik TX20 6,3 mm (1/4") 152 mm, splindiga [00341272] poltidele

Nõue:

- ✓ Seade on toitest lahutatud.
- ✓ Seade on veeühendusest lahutatud.

4.1.1 Tööpinna eemaldamine

- ▶ 1. Eemaldage kruvid (1).
- ▶ 2. Suruge tööpinna seadme tagasuunas (2).
- ▶ 3. Liigutage tööpinna eemaldamiseks ülessuunas (3).

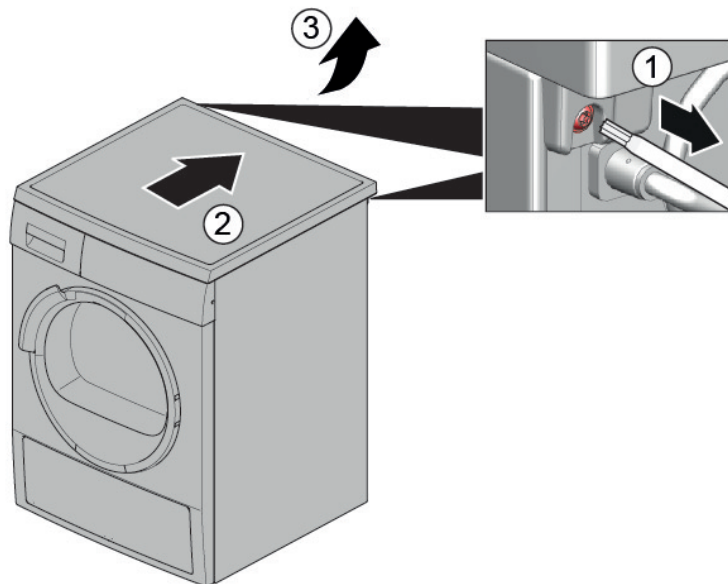



4.1.2 Tööpinna paigaldamine

- ▶ Paigaldage vastupidises järjekorras.

4.2 Välispaneeli vahetamine

	<p>⚠ ETTEVAATUST!</p> <p>Teravad korpuse osad! Lõikehaavad</p> <ul style="list-style-type: none"> ▶ Kandke kaitsekindaid.
--	--

	<p>⚠ HOIATUS</p> <p>Viltuses asendis seadmete libisemisoht! Luumurrud/muljumised</p> <ul style="list-style-type: none"> ▶ Kindlustage seadmed libisemise vastu.
--	--

	<p>⚠ ETTEVAATUST!</p> <p>Lahtikeeratud poltidest tingitud osade kukkumisoht! Kukkuvatest osadest tingitud vigastused.</p> <ul style="list-style-type: none"> ▶ Kinnitage osa allakukkumise vastu.
--	--

	<p>TÄHELEPANU!</p> <p>Lahtikeeratud poltidest tingitud osade kukkumisoht! Seadme teiste osade kahjustused või klientide vara kahjustused.</p> <ul style="list-style-type: none"> ▶ Kinnitage osa allakukkumise vastu.
--	--

Nõue:

- ✔ Seade on toitest lahutatud.
- ✔ Seade on veeühendusest lahutatud.
- ✔ [Tööpind on eemaldatud.→139](#)
- ✔ [Pesuaine sahtel eemaldatud.→141](#)

4.2.1 Välispaneeli eemaldamine

1. 1. Eemaldage kruvid (1).
2. 2. Vabastage kinnituselemendid (2, 3).

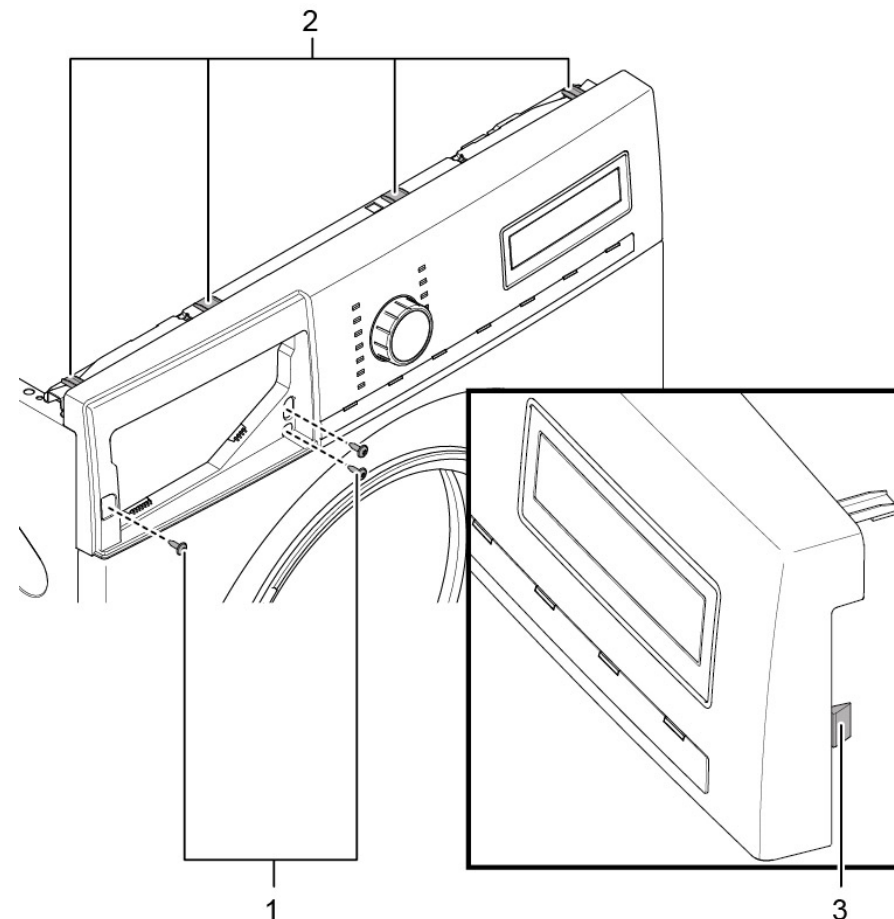

2. Lahutage juhtseadise pistik.
3. Eemaldage välispaneel.

4.2.2 Välispaneeli paigaldamine

- ▶ Paigaldage vastupidises järjekorras.

4.3 Pesuaine sahtli vahetamine

Nõue:

- ✓ Seade on toitest lahutatud.
- ✓ Seade on veeühendusest lahutatud.

4.3.1 Pesuaine sahtli eemaldamine

1. Tõmmake pesuaine sahtel välja.
2. 1. Suru kasseti (1) alla.
2. Eemaldage pesuaine sahtel (2).

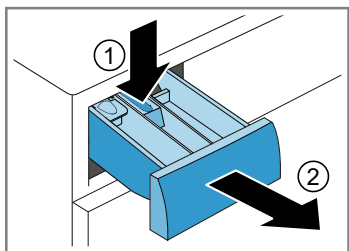

4.3.2 Pesuaine sahtli paigaldamine

- ▶ Paigaldage vastupidises järjekorras.

4.4 Pesuaine sahtli käepideme vahetamine

Nõue:

- ✓ Seade on toitest lahutatud.
- ✓ Seade on veeühendusest lahutatud.
- ✓ [Pesuaine sahtel eemaldatud.](#)→141

4.4.1 Pesuaine sahtli käepideme eemaldamine

1. Vabastage kinnituselemendid.

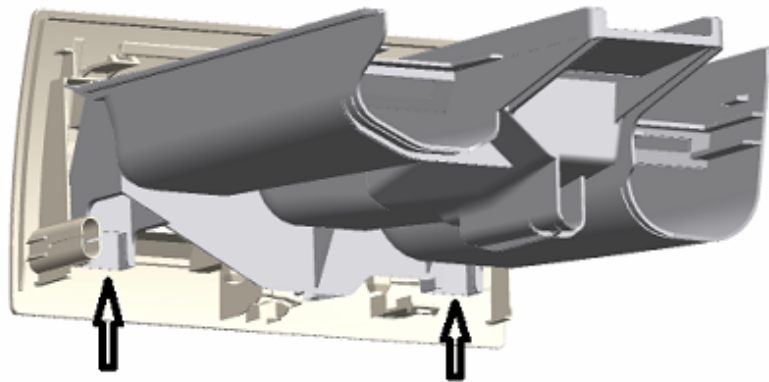

2. Eemaldage pesuaine sahtli käepide.

4.4.2 Pesuaine sahtli käepideme paigaldamine

- ▶ Paigaldage vastupidises järjekorras.

4.5 Ukse vahetamine



⚠ ETTEVAATUST!

Avatud liigendi piirkond!

Sõrmede muljumine/kinnijäämine

- ▶ Ärge pistke käsi liigendi piirkonda.
- ▶ Kandke kaitsekindaid.

Nõue:

- ✔ Seade on toitest lahutatud.
- ✔ Seade on veeühendusest lahutatud.
- ✔ Uks on avatud.

4.5.1 Ukse eemaldamine

1.



TÄHELEPANU!

Lahtikeeratud poltidest tingitud osade kukumisoht!

Seadme teiste osade kahjustused või klientide vara kahjustused.

- ▶ Kinnitage osa allakukkumise vastu.



⚠ ETTEVAATUST!

Lahtikeeratud poltidest tingitud osade kukumisoht!

Kukkuvatest osadest tingitud vigastused.

- ▶ Kinnitage osa allakukkumise vastu.

Eemaldage kruvid (1).

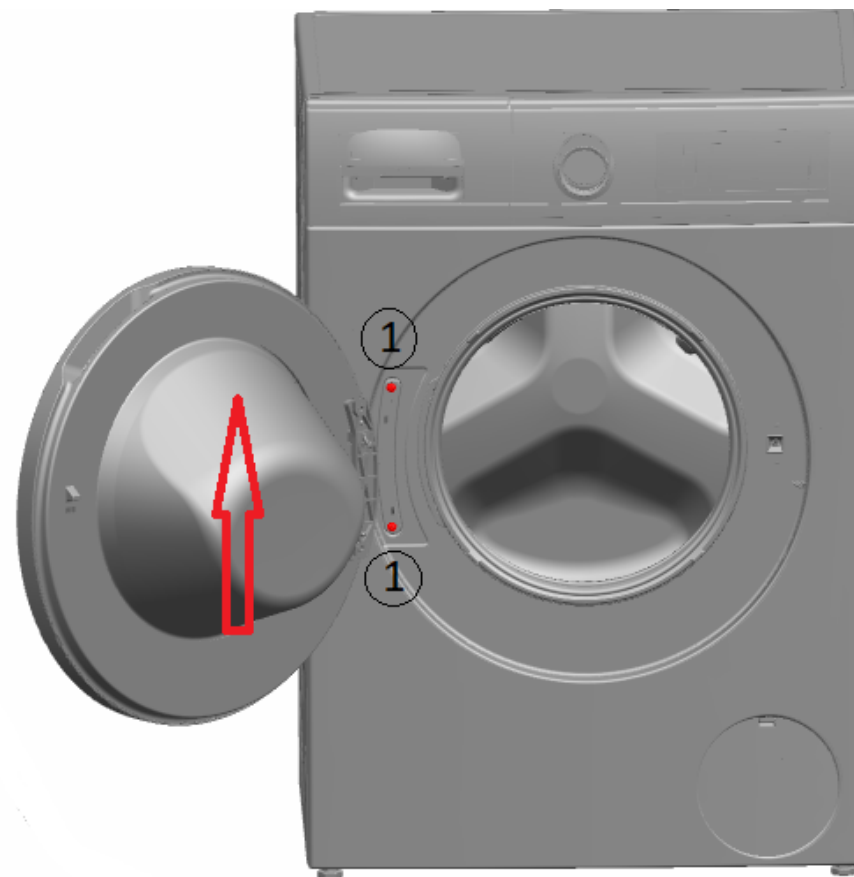

2. Eemaldage uks ülessuunas.

4.5.2 Ukse paigaldamine

- ▶ Paigaldage vastupidises järjekorras.

4.6 Ukseosade vahetamine



⚠ ETTEVAATUST!

Avatud liigendi piirkond!

Sõrmede muljumine/kinnijäämine

- ▶ Ärge pistke käsi liigendi piirkonda.
- ▶ Kandke kaitsekindaid.

Nõue:

- ✔ Seade on toitest lahutatud.
- ✔ Seade on veeühendusest lahutatud.
- ✔ [Uks on eemaldatud.→143](#)

4.6.1 Ukse osade eemaldamine

- ▶ Võtke uks lahti seestpoolt väljapoole.

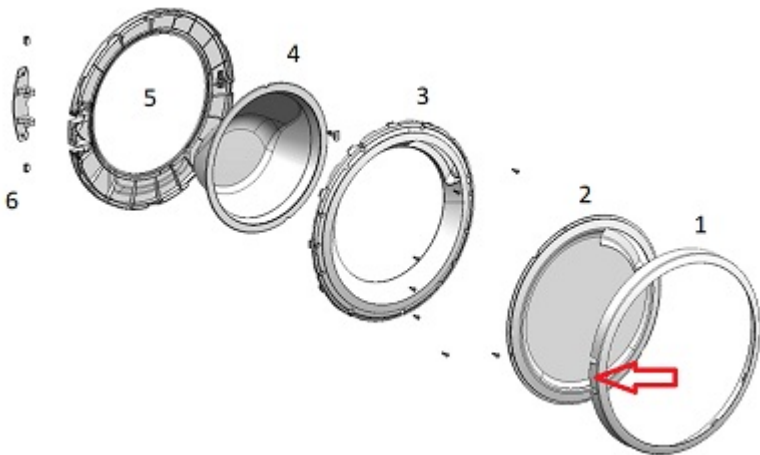



4.6.2 Ukse osade paigaldamine

- ▶ Paigaldage vastupidises järjekorras.

4.7 Ukse tihendi vahetamine

	⚠ ETTEVAATUST!
	<p>Teravad korpuse osad! Lõikehaavad</p> <ul style="list-style-type: none"> ▶ Kandke kaitsekindaid.

	⚠ ETTEVAATUST!
	<p>Lahtikeeratud poltidest tingitud osade kukkumisoht! Kukkuvatest osadest tingitud vigastused.</p> <ul style="list-style-type: none"> ▶ Kinnitage osa allakukkumise vastu.

	TÄHELEPANU!
	<p>Lahtikeeratud poltidest tingitud osade kukkumisoht! Seadme teiste osade kahjustused või klientide vara kahjustused.</p> <ul style="list-style-type: none"> ▶ Kinnitage osa allakukkumise vastu.

Nõue:

- ✓ Seade on toitest lahutatud.
- ✓ Seade on veeühendusest lahutatud.
- ✓ [Pesuaine sahtel eemaldatud.→141](#)
- ✓ [Uks on eemaldatud.→143](#)
- ✓ [Pumba kaas on eemaldatud.→152](#)

4.7.1 Ukse tihendi eemaldamine

1. 	⚠ HOIATUS
	<p>Viltuses asendis seadmete libisemisoht! Luumurrud/muljumised</p> <ul style="list-style-type: none"> ▶ Kindlustage seadmed libisemise vastu.

Kergitage seadet eestpoolt.

2. Vabastage esipaneeli alumised poldid (1).

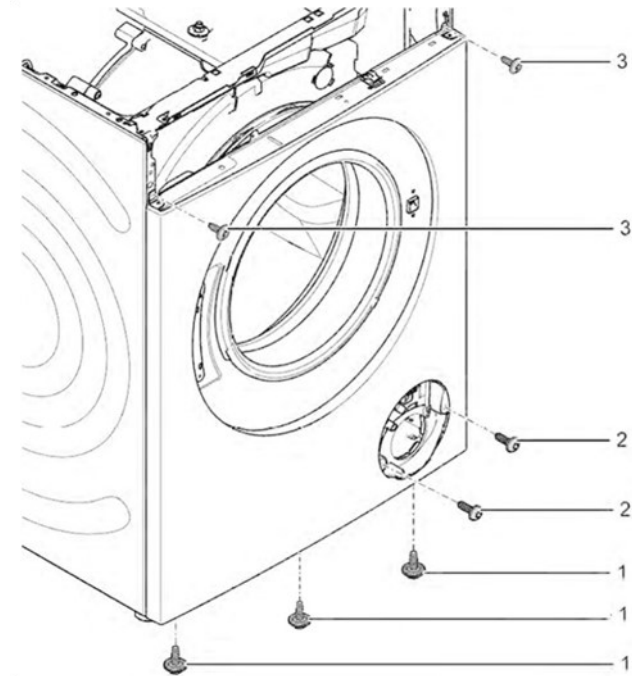

3. Langetage seadet allapoole.

4. Eemaldage pumbaala poldid (2).

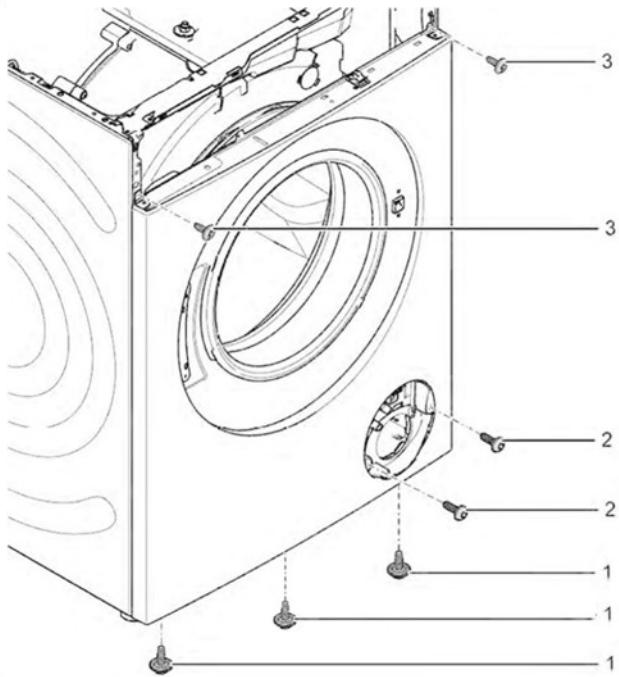

5. 1. Vabastage seadme tagaküljel olevad poldid (1).
2. Eemaldage tööpind (2, 3).

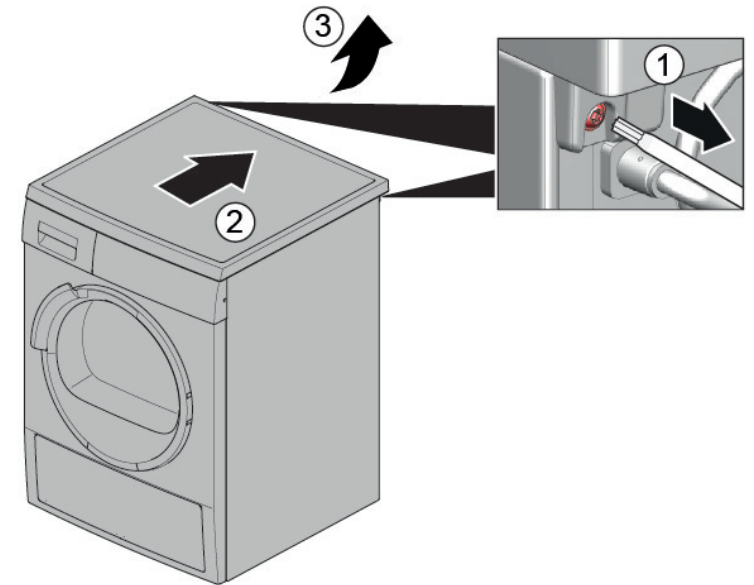

6. 1. Eemaldage kruvid (1).
2. Vabastage välispaneeli kinnituselemendid (2, 3).
3. Vabastage jaoturi korpuse poldid.

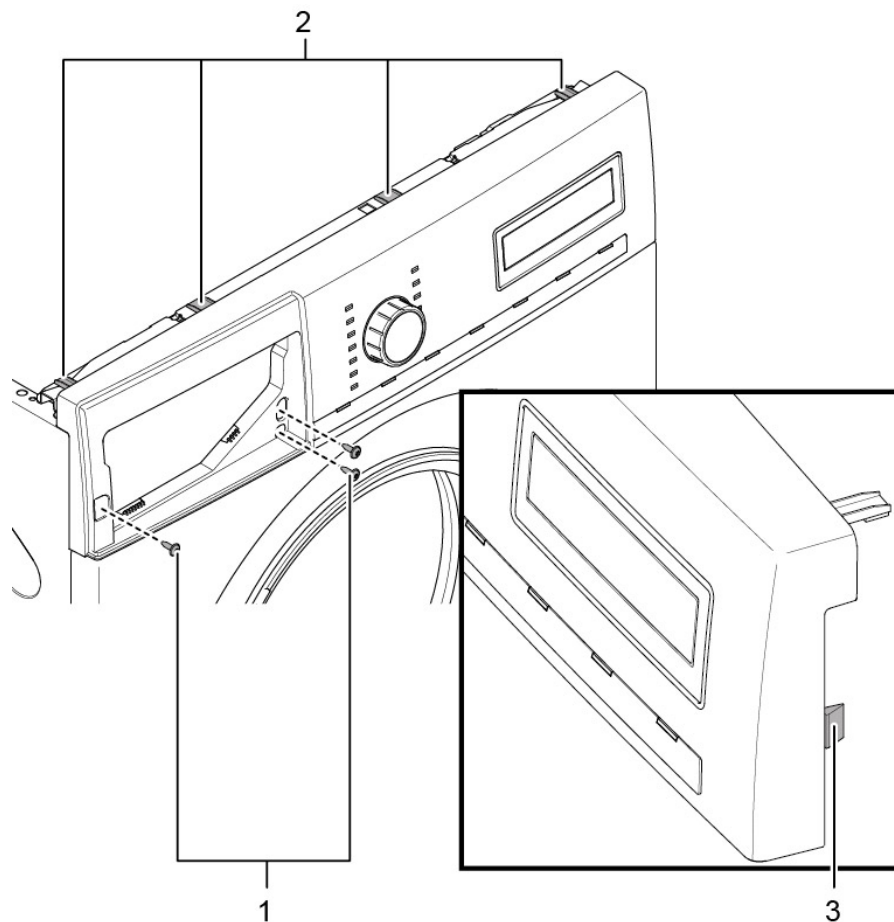

7. Eemaldage välispaneel.

8. Eemaldage üleval asuva trumli valgustuse hoidik.

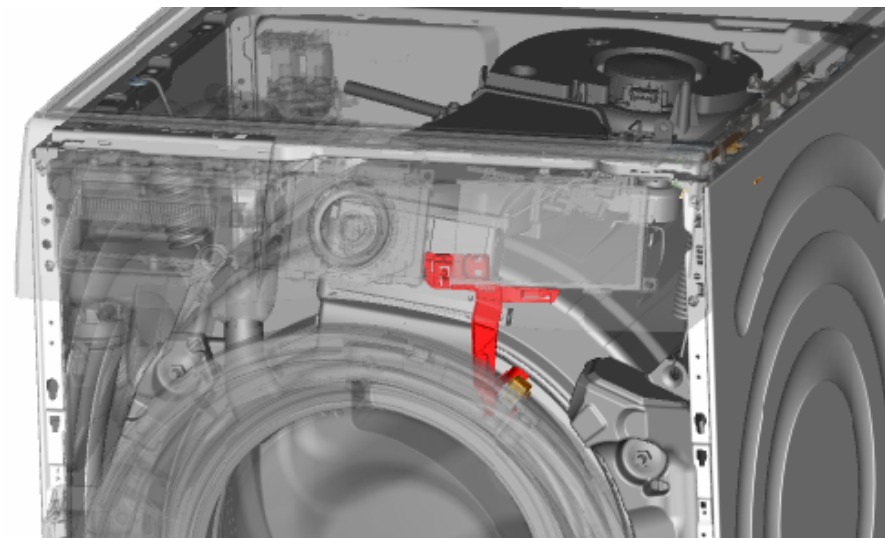

- 9.



TÄHELEPANU!

Pinna kahjustamise oht!

Valede tööriistadega võib seadme pind saada kriimustada.

- Kasutage pingutusrõnga vahetamisel ainult plastikust tööriistu.

Eemaldage pingutusrõngas muhvist plastikust tööriista abil.

10. Eemaldage esipaneeli tihend.
11. Vabastage kaabliühendus ukسلukult.

12. Vabastage esipaneeli ülemised poldid (3).

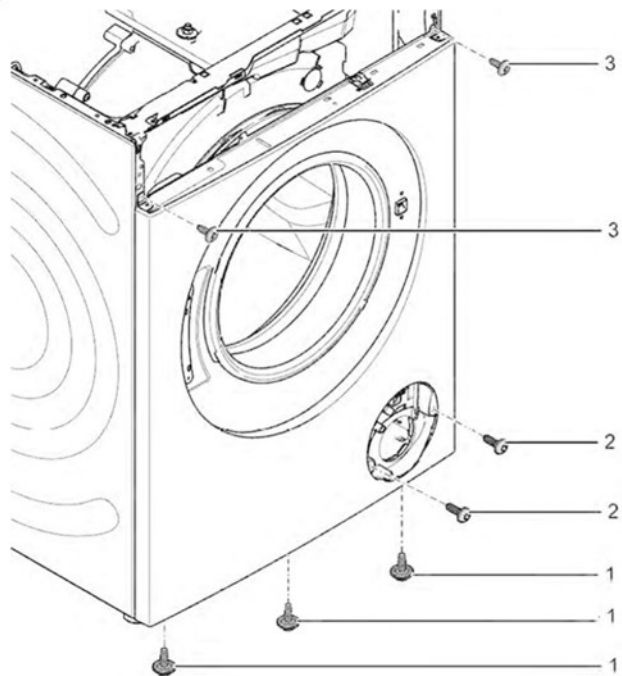

13. Eemaldage esipaneel.

14. Vabastage kõik voolikuühendused.

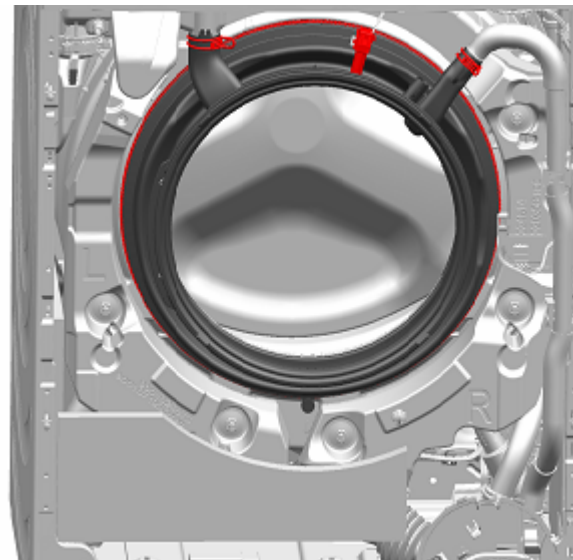

15. Eemaldage uksetihend.

4.7.2 Uksetihendi paigaldamine



HOIATUS

Valest paigaldusest tingitud osade kukumisoht!





Vigastused või seadme kahjustused.

► Pingutage pagasitihendi pingutusrõngast jõuga 3,4 Nm.

► Paigaldage vastupidises järjekorras.

4.8 Ukseluku vahetamine

Tootjana oleme kohustatud tagama tarbijatele ukseluku varuosad, sealhulgas remontimisjuhendi, vastavalt direktiivile (EL) 2019/2023. Siiski soovime viidata sellele, et pärast ukseluku vahetamist on enne seadme kasutuselevõttu vajalik lasta kvalifitseeritud elektrikul teha elektrotehniline ohutuskatse. See isik peab olema riiklike seaduste, määruste ja standardite järgi tõendatult koolitatud.

	<p>OHT</p> <p>Liikuvatest osadest tingitud elektrilöögi oht! Kui remonditööd on valesti tehtud, esineb elektrilöögist tingitud eluohu.</p> <ul style="list-style-type: none">▶ Elektrilisi osasid peavad parandama kvalifitseeritud elektrikud.▶ Pärast remonti peab olema tehtud ohutuskatse vastavalt standardile VDE 0701 või riiklikele määrustele.
	<p>ETTEVAATUST!</p> <p>Teravad korpuse osad! Lõikehaavad</p> <ul style="list-style-type: none">▶ Kandke kaitsekindaid.
	<p>HOIATUS</p> <p>Viltuses asendis seadmete libisemisoht! Luumurrud/muljumised</p> <ul style="list-style-type: none">▶ Kindlustage seadmed libisemise vastu.
	<p>ETTEVAATUST!</p> <p>Lahtikeeratud poltidest tingitud osade kukkumisoht! Kukkuvatest osadest tingitud vigastused.</p> <ul style="list-style-type: none">▶ Kinnitage osa allakukkumise vastu.
	<p>TÄHELEPANU!</p> <p>Lahtikeeratud poltidest tingitud osade kukkumisoht! Seadme teiste osade kahjustused või klientide vara kahjustused.</p> <ul style="list-style-type: none">▶ Kinnitage osa allakukkumise vastu.

Nõue:

- ✓ Seade on toitest lahutatud.
- ✓ Seade on veeühendusest lahutatud.
- ✓ Seadmetele pääseb vabalt ligi.

- ✓ [Tööpind on eemaldatud. → 139](#)
- ✓ Välispaneel on eemaldatud.
- ✓ [Uks on eemaldatud. → 143](#)
- ✓ Pingutusrõngas on eemaldatud.
- ✓ Esipaneel on eemaldatud.
- ✓ Uksetihend on eemaldatud.

4.8.1 Ukseluku eemaldamine

1. Ühendage ukseluku pistik lahti.
2. Vabastage ukselukk.



3. Eemaldage ukselukk.

4.8.2 Ukseluku paigaldamine

Ukseluk peab olema õiges asendis, et tagada seadme avariiuukse avanemise funktsioon.



- ▶ Paigaldage vastupidises järjekorras.

4.9 Trumli valgustuse vahetamine



⚠ ETTEVAATUST!

Teravad korpuse osad!
Lõikehaavad
▶ Kandke kaitsekindaid.



⚠ HOIATUS

Viltuses asendis seadmete libisemisoht!
Luumurrud/muljumised
▶ Kindlustage seadmed libisemise vastu.



⚠ ETTEVAATUST!

Lahtikeeratud poltidest tingitud osade kukkumisoht!
Kukkuvatest osadest tingitud vigastused.
▶ Kinnitage osa allakukkumise vastu.



TÄHELEPANU!

Lahtikeeratud poltidest tingitud osade kukkumisoht!
Seadme teiste osade kahjustused või klientide vara kahjustused.
▶ Kinnitage osa allakukkumise vastu.

Nõue:

- ✔ Seade on toitest lahutatud.
- ✔ Seade on veeühendusest lahutatud.
- ✔ Seadmetele pääseb vabalt ligi.
- ✔ [Tööpind on eemaldatud.→139](#)
- ✔ [Pesuaine sahtel eemaldatud.→141](#)
- ✔ Välispaneel on eemaldatud.

4.9.1 Trumli valgustuse eemaldamine

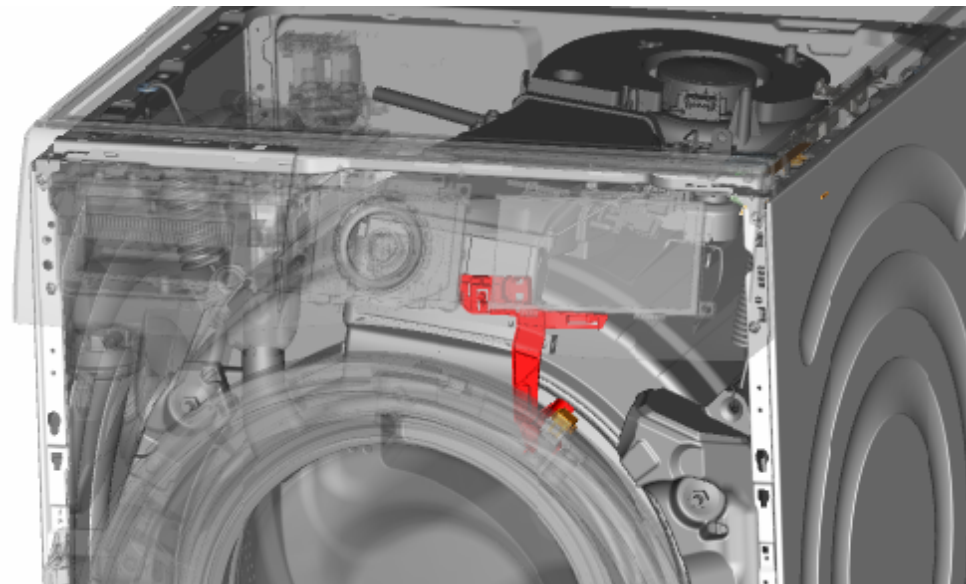

1. Tõmmake trumli valgustuse hoidik seadmest välja.
2. Ühendage elektriühendused lahti.
3. Eemaldage trumli valgustus trumli valgustuse hoidikust.

4.9.2 Trumli valgustuse paigaldamine

- ▶ Paigaldage vastupidises järjekorras.

4.10 Pumba katte vahetamine

Nõue:

- ✓ Seade on toitest lahutatud.
- ✓ Seade on veeühendusest lahutatud.

4.10.1 Pumba katte eemaldamine

1. Avage pumba kate.

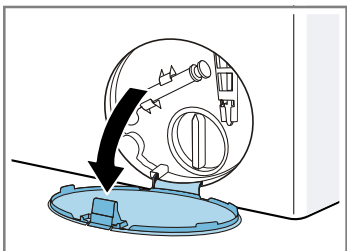

2. Eemaldage pumba kate.

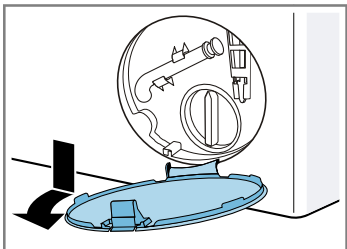

4.10.2 Pumba katte paigaldamine

- ▶ Paigaldage vastupidises järjekorras.

4.11 Esipaneeli vahetamine



⚠ ETTEVAATUST!

Teravad korpuse osad!
Lõikehaavad
▶ Kandke kaitsekindaid.

Nõue:

- ✓ Seade on toitest lahutatud.
- ✓ Seade on veeühendusest lahutatud.
- ✓ [Pesuaine sahtel eemaldatud.→141](#)
- ✓ [Uks on eemaldatud.→143](#)
- ✓ Uksetihend on eemaldatud.
- ✓ [Pumba kaas on eemaldatud.→152](#)

4.11.1 Esipaneeli eemaldamine

1.



⚠ HOIATUS

Viltuses asendis seadmete libisemisoht!
Luumurrud/muljumised
▶ Kindlustage seadmed libisemise vastu.

Kergitage seadet eestpoolt.

2. Eemaldage põhjal olevad poldid kruvid (1).

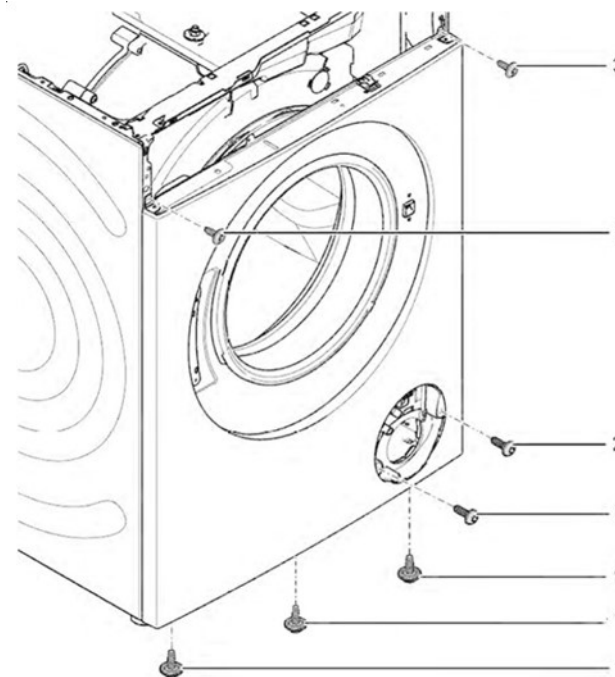

3. Langetage seadet allapoole.

Remont

4. 1. Eemaldage kruvid (1).
2. Suruge tööpinda seadme tagasuunas (2).
3. Liigutage tööpinda eemaldamiseks ülessuunas (3).

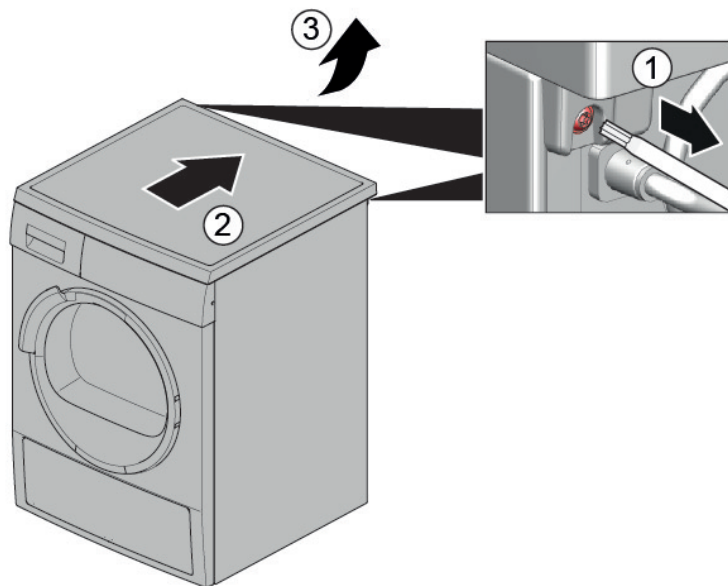

5. 1. Eemaldage kruvid (1).
2. Vabastage kinnituselemendid (2, 3).

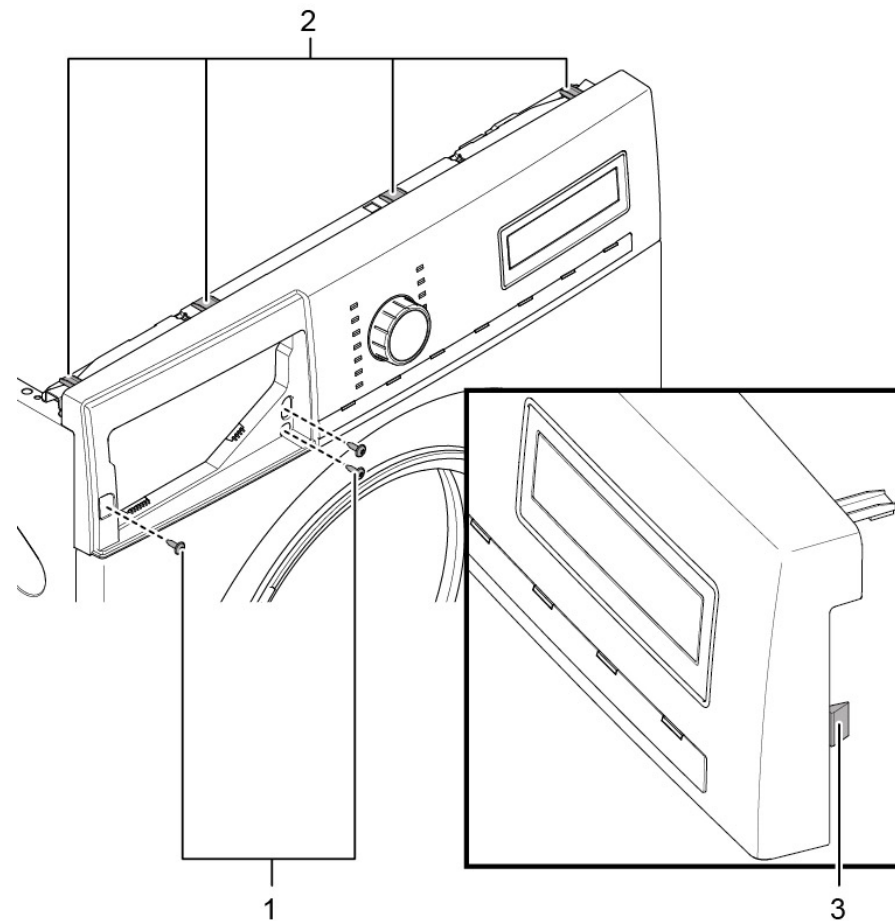

6. Eemaldage välispaneel.

7.



⚠ ETTEVAATUST!

Lahtikeeratud poldidest tingitud osade kukumisoht!

Kukkuvatest osadest tingitud vigastused.

- ▶ Kinnitage osa allakukkumise vastu.



TÄHELEPANU!

Lahtikeeratud poltidest tingitud osade kukumisoht!

Seadme teiste osade kahjustused või klientide vara kahjustused.

- ▶ Kinnitage osa allakukkumise vastu.

Eemaldage esiosal olevad poldid suunaga alt üles (2, 3).

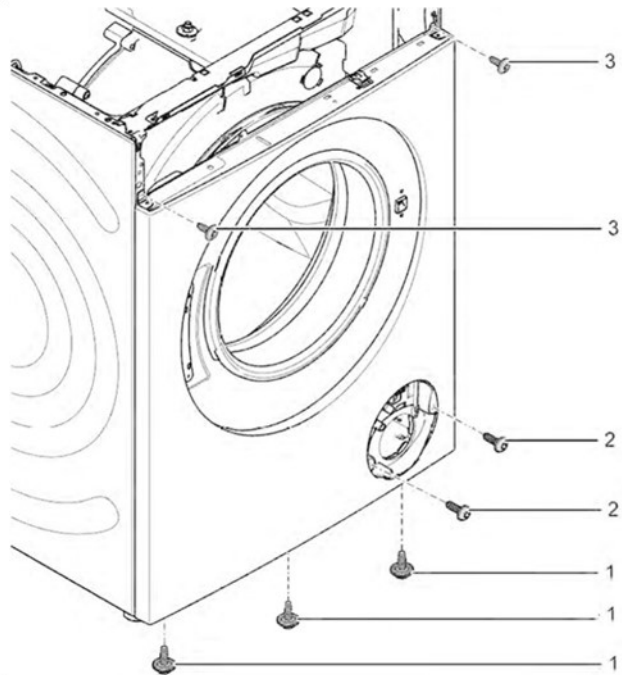





8. Eemaldage esipaneel.

4.11.2 Esipaneeli paigaldamine

- ▶ Paigaldage vastupidises järjekorras.

Korjausvinkit - Pyykinpesukone

 Tämä asiakirja	157
1.1 Tärkeitä tietoja.....	157
1.1.1 Tarkoitus	157
1.2 Symboleiden merkitys.....	157
1.2.1 Vaaratasot.....	157
1.2.2 Varoitusmerkit.....	157
1.2.3 Varoitusten rakenne	158
1.2.4 Yleiset symbolit.....	158
 Turvallisuus	159
2.1 Yleiset turvallisuusohjeet.....	159
2.1.1 Kaikki kotitalouskoneet.....	159
 Työkalut ja apuvälineet	160
 Korjaus	161
4.1 Työtason vaihtaminen.....	161
4.1.1 Työtason poistaminen	161
4.1.2 Työtason asennus.....	161
4.2 Ohjauspaneelin vaihtaminen	162
4.2.1 Ohjauspaneelin poistaminen.....	162
4.2.2 Ohjauspaneelin asentaminen.....	162
4.3 Pesuainelokeron vaihtaminen.....	163
4.3.1 Pesuainelokeron poistaminen	163
4.3.2 Pesuainelokeron asentaminen	163
4.4 Pesuainelokeron kahvan vaihtaminen	164
4.4.1 Pesuainelokeron kahvan poistaminen	164
4.4.2 Pesuainelokeron kahvan asentaminen	164
4.5 Luukun vaihtaminen.....	165
4.5.1 Luukun poistaminen	165
4.5.2 Luukun asennus	165
4.6 Luukun komponenttien vaihtaminen.....	166
4.6.1 Luukun komponenttien poistaminen	166
4.6.2 Luukun komponenttien asennus.....	166
4.7 Luukun tiivisteiden vaihtaminen.....	167
4.7.1 Luukun tiivisteiden poistaminen	167
4.7.2 Luukun tiivisteiden asennus	170

4.8 Luukun lukitsimen vaihtaminen	171
4.8.1 Luukun lukitsimen poistaminen.....	171
4.8.2 Luukun lukitsimen asennus	172
4.9 Rummun lampun vaihtaminen.....	173
4.9.1 Rummun lampun poistaminen	173
4.9.2 Rummun lampun asennus	173
4.10 Pumpun suojuksen vaihtaminen.....	174
4.10.1 Pumpun suojuksen poistaminen	174
4.10.2 Pumpun suojuksen asennus	174
4.11 Etupaneelin vaihtaminen	175
4.11.1 Etupaneelin poistaminen.....	175
4.11.2 Etupaneelin asentaminen.....	177

Tämä asiakirja

1.1 Tärkeitä tietoja

1.1.1 Tarkoitus

Näiden korjausohjeiden tarkoituksena on auttaa kuluttajaa korjaamaan laitteita itse ekologista suunnittelua koskevan asetuksen (päivitys 03/2021) mukaisesti.



Ne sisältävät tietoja siitä, miten määrätyt varaosat voidaan vaihtaa. Lisäksi niihin sisältyy tietoja varoituksista ja riskeistä.

Ota yhteyttä huoltopalveluun, jos sinulla on kysyttävää. Vastamme vahingoista vain, jos korjausohjeita on noudatettu oikein.

1.2 Symboleiden merkitys

1.2.1 Vaaratasot

Varoitustasot koostuvat symbolista ja huomiosanasta. Huomiosanat ilmoittava vaaran vakavuuden.

Varoitustaso	Merkitys
 VAARA	Varoituksen laiminlyönti johtaa kuolemaan tai vakaviin loukkaantumisiin.
 VAROITUS	Varoituksen laiminlyönti voi johtaa kuolemaan tai vakaviin loukkaantumisiin.
 HUOMAA	Varoituksen laiminlyönti voi johtaa lieviin loukkaantumisiin.
HUOMIO!	Varoituksen laiminlyönti voi johtaa omaisuusvahinkoihin.

Taulukko 1: Vaaratasot

1.2.2 Varoitusmerkit

Varoitusmerkit ovat symboleita sisältäviä esityksiä, jotka osoittavat vaaran tyyppin.

Tässä asiakirjassa käytetään seuraavia varoitusmerkkejä:

Varoitusmerkki	Merkitys
	Yleinen varoitus
	Sähköjännitteestä aiheutuva vaara
	Räjähdysvaara
	Viiltohaavojen vaara
	Murskautumisen vaara

Tämä asiakirja

Varoitusmerkki	Merkitys
	Kuumista pinnoista aiheutuva vaara
	Voimakkaasta magneettikentästä aiheutuva vaara
	Ionisoimattomasta säteilystä aiheutuva vaara



Taulukko 2: Varoitusmerkit

1.2.3 Varoitusten rakenne

Tämän asiakirjan sisältämillä varoituksilla on standardoitu ulkonäkö ja rakenne.



	<div style="background-color: red; color: white; padding: 2px; text-align: center;"> VAARA</div> <p>Vaaran tyyppi ja lähde! Vaaran/varoituksen laiminlyönnistä mahdollisesti aiheutuvat seuraukset.</p> <ul style="list-style-type: none">▶ Vaaran ehkäisemiseen liittyvät toimenpiteet ja kiellot.
--	--

Seuraavassa esimerkissä näytetään varoitus, joka varoittaa jännitteisten osien aiheuttamasta sähköiskusta. Vaaran välttämiseksi suoritettava toimenpide mainitaan.

	<div style="background-color: red; color: white; padding: 2px; text-align: center;"> VAARA</div> <p>Jännitteisten osien aiheuttama sähköiskun vaara! Sähköiskun aiheuttama kuolema</p> <ul style="list-style-type: none">▶ Erotta laitteet sähkövirrasta vähintään 60 sekuntia ennen korjaustöiden aloittamista.
---	---

1.2.4 Yleiset symbolit

Tässä asiakirjassa käytetään seuraavia yleisiä symboleja:

Yl. symboli	Merkitys
	Erikoisohjeen tunniste (teksti ja/tai kaavio)
	Yksinkertaisen ohjeen tunniste (vain teksti)

Yl. symboli	Merkitys
	Video-opetusohjelmaan johtavan linkin tunniste
	Tarvittavien työkalujen tunniste
	Tarvittavien edellytysten tunniste
	Ehdon (jos ..., sitten ...) tunniste
	Tuloksen tunniste
	Näppäimen tai painikkeen tunniste
	Materiaalinumeron tunniste
	Näytetyn tekstin/ikkunan (laitteen näytössä) tunniste

Taulukko 3: Yleiset symbolit

2.1 Yleiset turvallisuusohjeet

2.1.1 Kaikki kotitalouskoneet

Jännitteisten osien aiheuttama sähköiskun vaara!

- Virheet sähkökomponentteja sisältävissä korjauksissa voivat johtaa sähköiskuun!
- Kytke kone irti verkkovirrasta vähintään 60 sekuntia ennen töiden aloittamista.
- Pyydä korjauksen jälkeen suorittamaan VDE 0701 -säädöksen tai maakohtaisten säädösten mukainen turvallisuustesti.

Terävistä reunoista aiheutuva loukkaantumisvaara!

- Käytä suojakäsineitä.

Painavista ja liikkuvista komponenteista aiheutuva murskautumisen riski korjauksen, kunnossapidon, vianetsinnän ja huollon aikana

- Käytä suojakenkiä.
- Estä painavien komponenttien putoaminen.
- Älä koske liikkuviin komponentteihin.







Laitteen turvallisuudelle/toiminnalle aiheutuva riski!





- Käytä vain alkuperäisiä varaosia.

Staattiselle sähkölle herkkien komponenttien (ESDS) vaurioitumisen riski!

- Älä koske moduuleihin, liitännät ja johdinreitit mukaan luettuna.

Työkalut ja apuvälineet

Nimitys	Yksityiskohdat	Kuvat
Lisätyökalu [15000155]	Työkalu, jota käytetään muoviosien irrottamiseen	
Torx T20 -ruuvimeisseli, reiällinen [00340764]	100 mm, ruuveille lukituksella	
Momenttiavain [15000441]	Momenttiavain 20 - 100 Nm	
Uraruuvimeisseli [00340854]	Terä 3,5 mm x 0,6 mm x 100 mm, suojaeristys 1000 V AC	
Uraruuvimeisseli [00340855]	Terä 5,5 mm x 1,0 mm x 125 mm, suojaeristys 1000 V AC	
Nokkapihdit, taivutetut [00341269]	Pituus 200 mm	
Sivuleikkurit [00342182]	Pituus: 200 mm	



Nimitys	Yksityiskohdat	Kuvat
Yhdistelmä kiintoavain [00340811]	Avainväli 10 ^o mm, M6	
Combination wrench [00340814]	Avainväli 13 ^o mm, M8	
Yhdistelmä kiintoavain [00340817]	Avainväli 17 mm, M10	
Yhdistelmä kiintoavain [15000459]	Avainväli 16 ^o mm, M10	

4.1 Työtason vaihtaminen

Erikoistyökalut:

-  Torx-kärki TX20, reikä, pitkä 6,3°mm (1/4") 152°mm, ruuveille lukituksella [00341272]

Vaatus:

-  Kone on erotettu teholahteesta.
-  Kone on erotettu vedenjakelusta.

4.1.1 Työtason poistaminen

- ▶ 1. Poista ruuvit (1).
- ▶ 2. Työnnä työtaso koneen takaosaan (2).
- ▶ 3. Nosta työtasoa ylös (3) ja poista se.

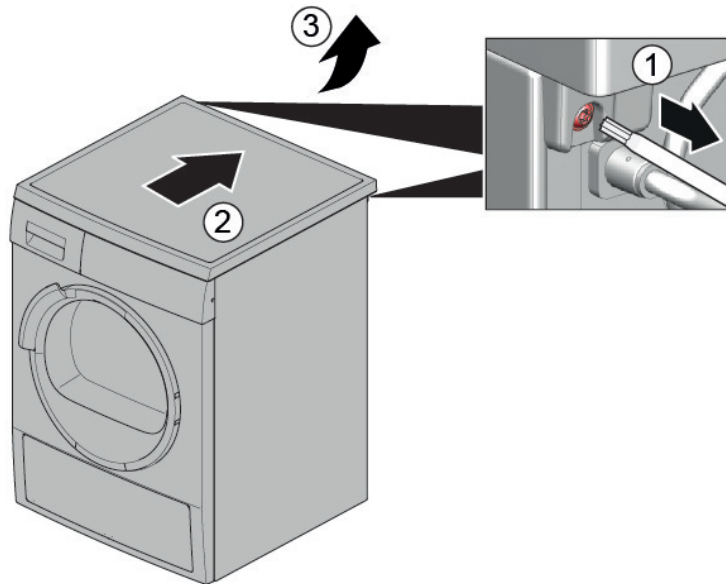



4.1.2 Työtason asennus

- ▶ Asenna vastakkaisessa järjestyksessä.

4.2 Ohjauspaneelin vaihtaminen

	⚠ HUOMAA
Terävät kotelon reunat! Viiltovammat ▶ Käytä suojakäsineitä.	

	⚠ VAROITUS
Kallistetun koneen luiskahtaminen! Luunmurtumat/murskavammat ▶ Estä koneiden luiskahtaminen.	

	⚠ HUOMAA
Ruuvien avaamisesta aiheutuva osien putoamisen riski! Loukkaantuminen putoavien osien vuoksi. ▶ Estä komponentin putoaminen.	

	HUOMIO!
Ruuvien avaamisesta aiheutuva osien putoamisen riski! Vauriot koneen muille osille tai asiakkaan kodille, esim. lattia. ▶ Estä komponentin putoaminen.	

Vaatus:

- ✔ Kone on erotettu teholähteestä.
- ✔ Kone on erotettu vedenjakelusta.
- ✔ [Työtaso on poistettu.→161](#)
- ✔ [Pesuainelokero on poistettu.→163](#)

4.2.1 Ohjauspaneelin poistaminen

1. 1. Poista ruuvit (1).
2. 2. Vapauta lukitusosat (2, 3).

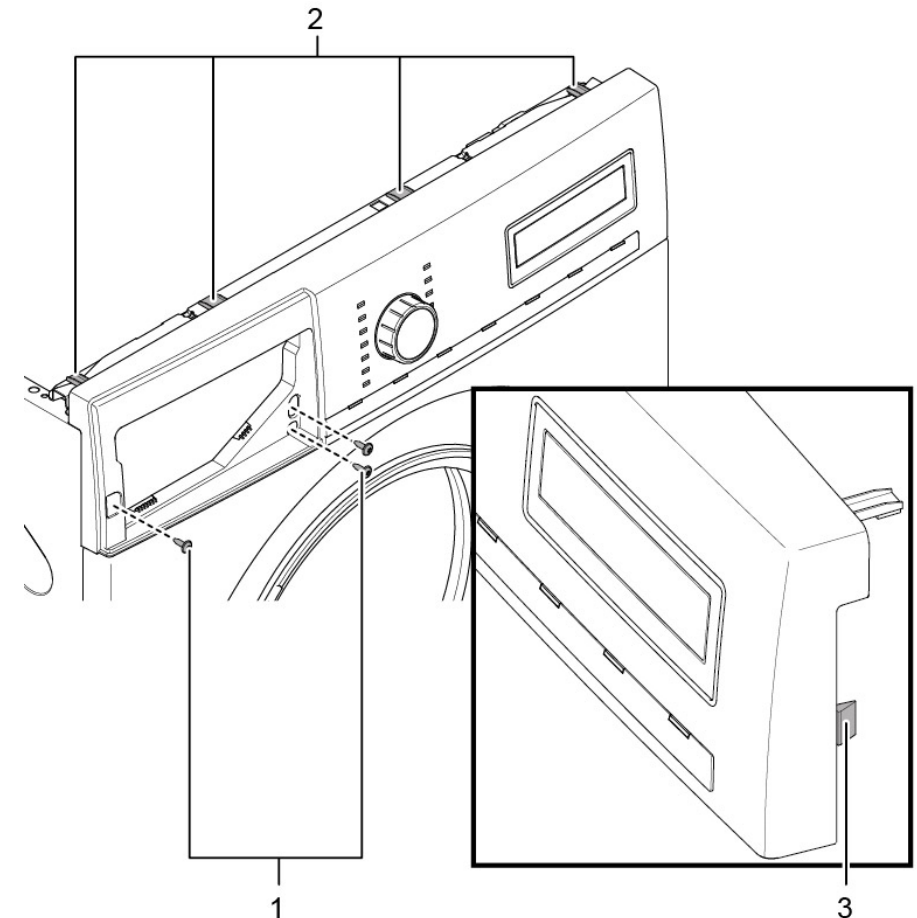

2. Irrota ohjausyksikön pistokekontakti.
3. Poista ohjauspaneeli.

4.2.2 Ohjauspaneelin asentaminen

- ▶ Asenna vastakkaisessa järjestyksessä.

4.3 Pesuainelokeron vaihtaminen

Vaatus:

- ✓ Kone on erotettu tehölähteestä.
- ✓ Kone on erotettu vedenjakelusta.

4.3.1 Pesuainelokeron poistaminen

1. Vedä pesuainelokero ulos.
2. 1. Paina liitintä sisään (1).
2. Poista pesuainelokero (2).

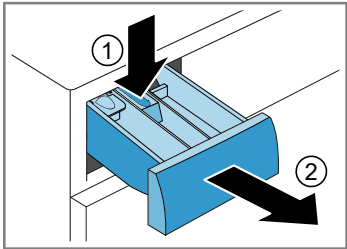

4.3.2 Pesuainelokeron asentaminen

- ▶ Asenna vastakkaisessa järjestyksessä.

4.4 Pesuainelokeron kahvan vaihtaminen

Vaatus:

- ✓ Kone on erotettu tehölähteestä.
- ✓ Kone on erotettu vedenjakelusta.
- ✓ [Pesuainelokero on poistettu.→ 163](#)

4.4.1 Pesuainelokeron kahvan poistaminen

1. Vapauta lukitusosat.

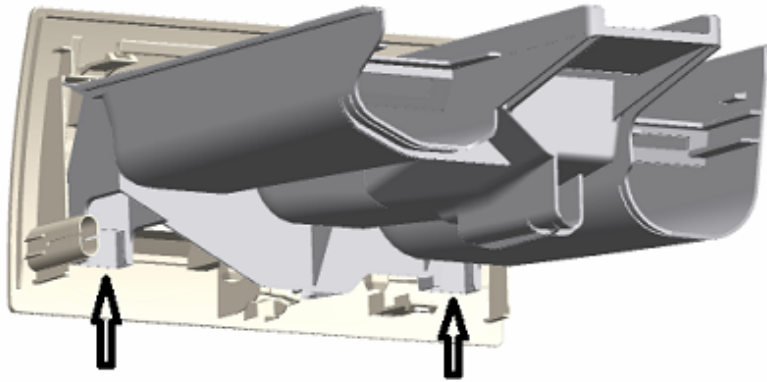

2. Poista pesuainelokeron kahva.

4.4.2 Pesuainelokeron kahvan asentaminen

- Asenna vastakkaisessa järjestyksessä.

4.5 Luukun vaihtaminen

	⚠ HUOMAA Avoim saranan alue! Sormien murskautuminen / jääminen väliin ▶ Älä koske saranan alueelle. ▶ Käytä suojakäsineitä.
--	---

Vaatus:

- ✔ Kone on erotettu teholähteestä.
- ✔ Kone on erotettu vedenjakelusta.
- ✔ Luukku on avattu.

4.5.1 Luukun poistaminen

1.

	HUOMIO! Ruuvien avaamisesta aiheutuva osien putoamisen riski! Vauriot koneen muille osille tai asiakkaan kodille, esim. lattia. ▶ Estä komponentin putoaminen.
---	---

	⚠ HUOMAA Ruuvien avaamisesta aiheutuva osien putoamisen riski! Loukkaantuminen putoavien osien vuoksi. ▶ Estä komponentin putoaminen.
---	--

Poista ruuvit (1).

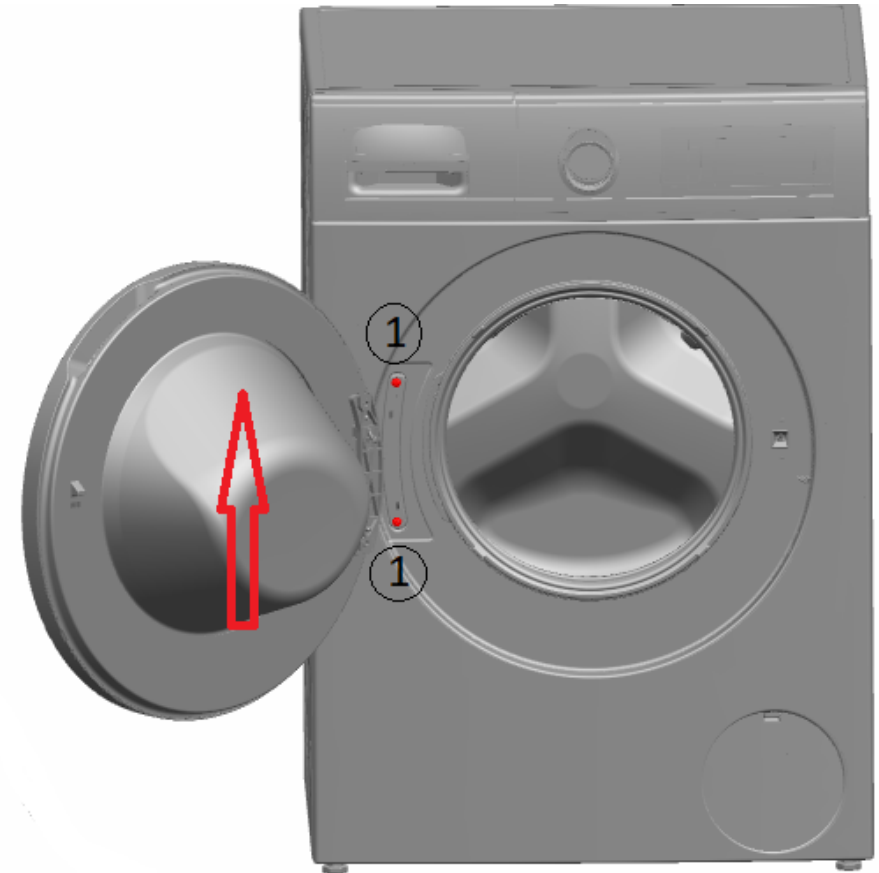

2. Poista luukku yläsuuntaan.

4.5.2 Luukun asennus

- ▶ Asenna vastakkaisessa järjestyksessä.

4.6 Luukun komponenttien vaihtaminen



⚠ HUOMAA

Avoim saranan alue!

- Sormien murskautuminen / jääminen väliin
- ▶ Älä koske saranan alueelle.
 - ▶ Käytä suojakäsineitä.

Vaatus:

- ✓ Kone on erotettu teholahteesta.
- ✓ Kone on erotettu vedenjakelusta.
- ✓ [Luukku on poistettu.→165](#)

4.6.1 Luukun komponenttien poistaminen

- ▶ Pura luukku osiin ulkoa sisäänpäin.

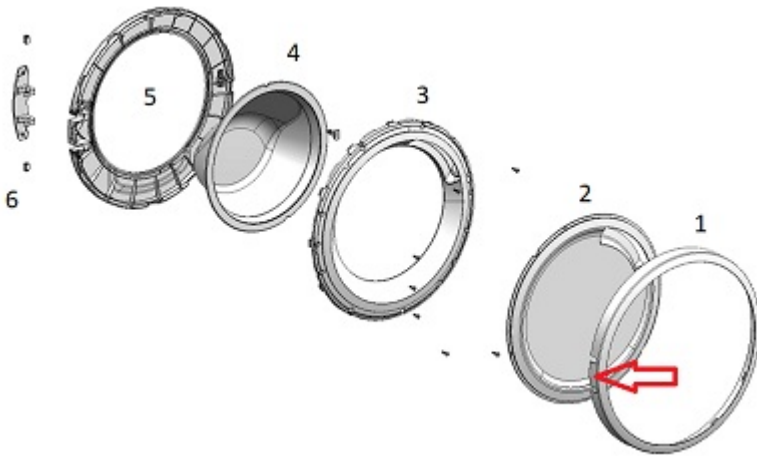



4.6.2 Luukun komponenttien asennus

- ▶ Asenna vastakkaisessa järjestyksessä.

4.7 Luukun tiivisteiden vaihtaminen

	⚠ HUOMAA
	Terävät kotelon reunat! Viiltovammat ▶ Käytä suojakäsineitä.

	⚠ HUOMAA
	Ruuvien avaamisesta aiheutuva osien putoamisen riski! Loukkaantuminen putoavien osien vuoksi. ▶ Estä komponentin putoaminen.

	HUOMIO!
	Ruuvien avaamisesta aiheutuva osien putoamisen riski! Vauriot koneen muille osille tai asiakkaan kodille, esim. lattia. ▶ Estä komponentin putoaminen.

Vaatus:

- ✓ Kone on erotettu tehollähteestä.
- ✓ Kone on erotettu vedenjakelusta.
- ✓ [Pesuainelokero on poistettu.→163](#)
- ✓ [Luukku on poistettu.→165](#)
- ✓ [Pumpun suojuus on poistettu.→174](#)

4.7.1 Luukun tiivisteiden poistaminen

	⚠ VAROITUS
	Kallistetun koneen luiskahtaminen.! Luunmurtumat/murskavammat ▶ Estä koneiden luiskahtaminen.

Nosta konetta ylös edestä.

2. Avaa ruuvit etupaneelin alaosassa (1).

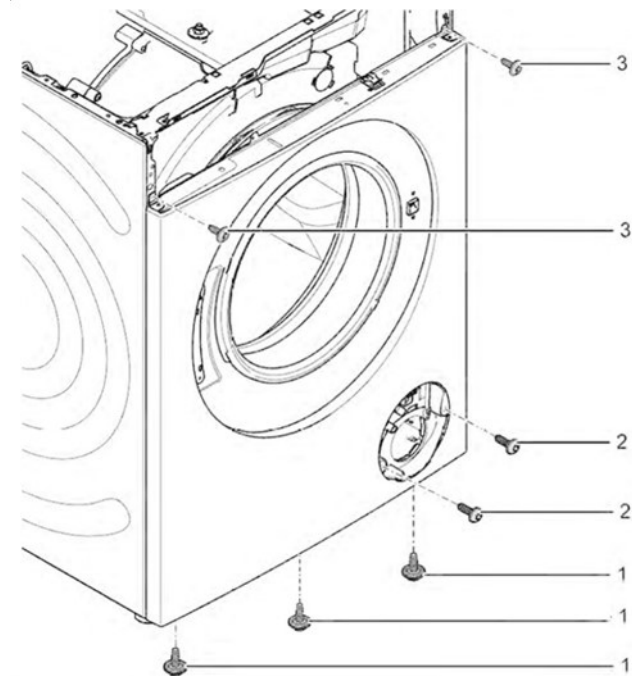

3. Laske kone alas.

4. Poista ruuvit pumpun alueelta (2).

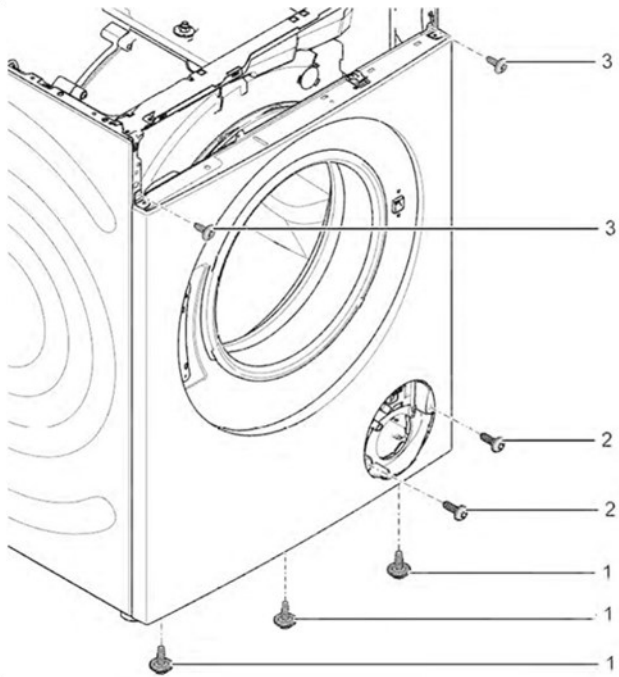

5. 1. Avaa ruuvit koneen takana (1).
2. Poista työtaso (2, 3).

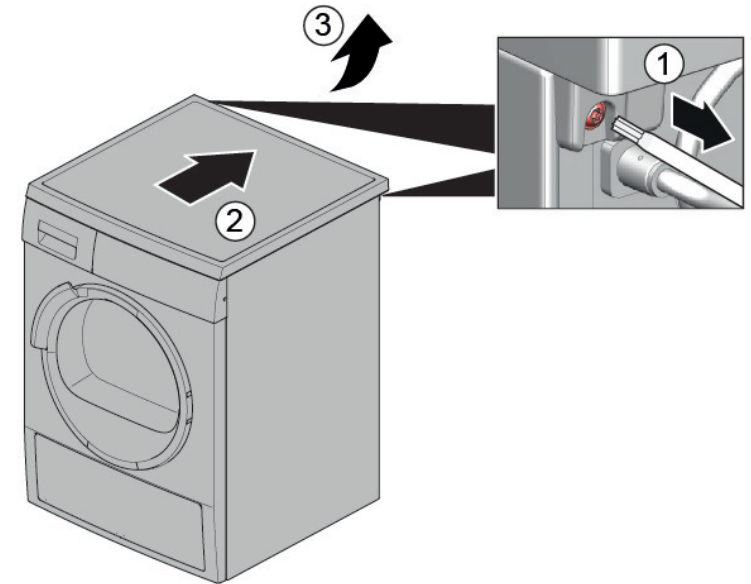

6. 1. Poista ruuvit (1).
2. Vapauta ohjauspaneelin lukitusosat (2, 3).
3. Avaa annostelukotelon ruuvit.

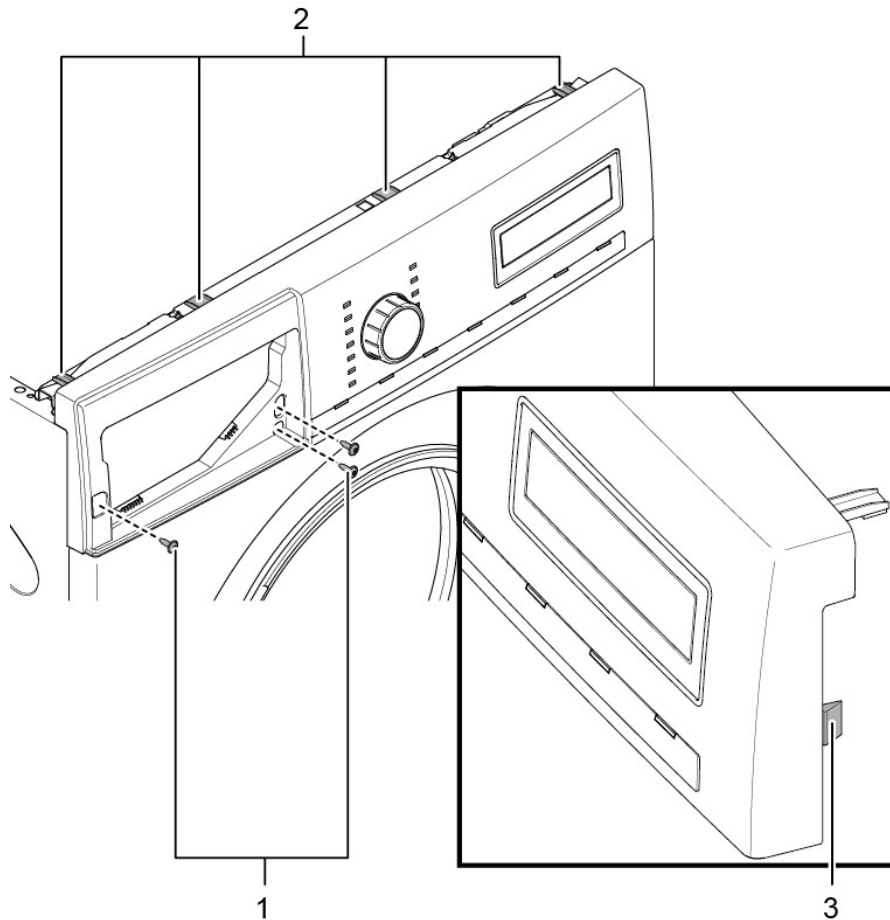

7. Poista ohjauspaneeli.

8. Poista rummun lampunpidike yläosasta.

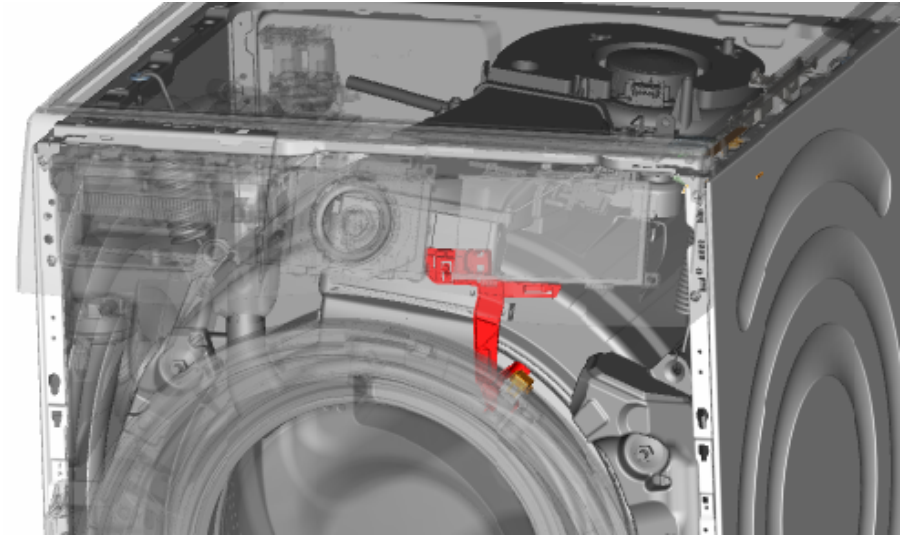

- 9.



HUOMIO!

Pinnan vaurioitumisen riski!

Koneen pinta voi naarmuuntua, jos käytetään väärä työkaluja.

- Käytä kiristysrenkaan vaihtamiseen vain muovisia työkaluja.

Poista kiristysrenkas tiivisteestä muovisella työkalulla.

10. Irrota luukun tiiviste etupaneelistä.
11. Irrota kaapeliliitin luukun lukitsimesta.

12. Avaa ruuvit etupaneelin yläosassa (3).

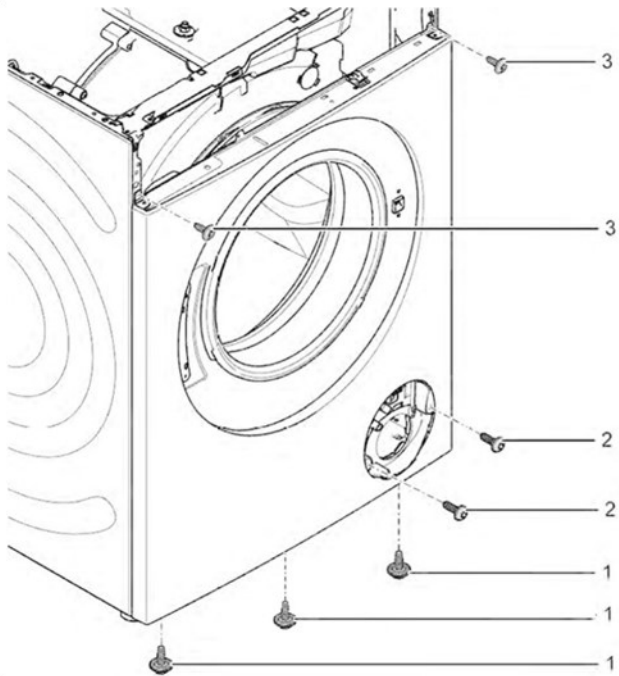

13. Poista etupaneeli.

14. Irrota kaikki letkuliitännät.

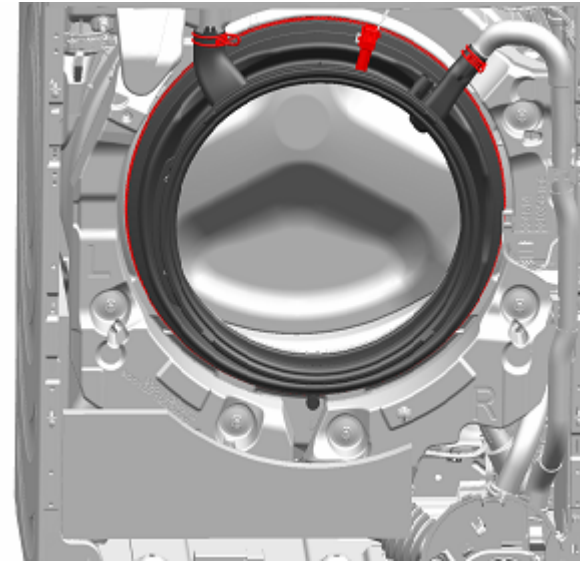

15. Poista luukun tiiviste.

4.7.2 Luukun tiivisteiden asennus

	VAROITUS
	Väärästä asennuksesta aiheutuva osien putoamisen riski! Loukkaantuminen tai laitteen vahingoittuminen. ▶ Kiristä kumitiivisteiden kiristysrenkas 3,4 Nm:llä.

▶ Asenna vastakkaisessa järjestyksessä.

4.8 Luukun lukitsimen vaihtaminen

Valmistajana olemme velvoitettuja toimittamaan kuluttajille varaosana ovilukon sekä korjausohjeet (EU) 2019/2023 -säädöksen mukaisesti. Haluaisimme kuitenkin huomauttaa, että ovilukon vaihtamisen jälkeen pätevän sähköasentajan on testattava sähkötekninen turvallisuus ennen kuin laite otetaan uudelleen käyttöön. Tällä henkilöllä on oltava todistettavissa oleva pätevyys maan erityisten lakien, säädösten ja standardien mukaisesti.

	VAARA
	<p>Jännitteisten osien aiheuttama sähköiskun vaara! Sähköiskusta aiheutuva hengenvaara väärän korjauksen tapauksessa</p> <ul style="list-style-type: none"> ▶ Sähköosien korjaus tulisi antaa pätevien sähköasentajien suorittavaksi. ▶ Pyydä korjauksen jälkeen suorittamaan VDE 0701 -säädöksen tai maakontaisten säädösten mukainen turvallisuustesti.

	HUOMAA
	<p>Terävät kotelon reunat! Viiltovammat</p> <ul style="list-style-type: none"> ▶ Käytä suojakäsineitä.

	VAROITUS
	<p>Kallistetun koneen luiskahtaminen! Luunmurtumat/murskavammat</p> <ul style="list-style-type: none"> ▶ Estä koneiden luiskahtaminen.

	HUOMAA
	<p>Ruuvien avaamisesta aiheutuva osien putoamisen riski! Loukkaantuminen putoavien osien vuoksi.</p> <ul style="list-style-type: none"> ▶ Estä komponentin putoaminen.

	HUOMIO!
	<p>Ruuvien avaamisesta aiheutuva osien putoamisen riski! Vauriot koneen muille osille tai asiakkaan kodille, esim. lattia.</p> <ul style="list-style-type: none"> ▶ Estä komponentin putoaminen.

Vaatus:

- ✓ Kone on erotettu tehollisesta.
- ✓ Kone on erotettu vedenjakelusta.

- ✓ Koneeseen on vapaa pääsy.
- ✓ [Työtaso on poistettu.→161](#)
- ✓ Ohjauspaneeli on poistettu.
- ✓ [Luukku on poistettu.→165](#)
- ✓ Kiristysrenkas on poistettu.
- ✓ Etupaneeli on poistettu.
- ✓ Luukun tiiviste on poistettu.

4.8.1 Luukun lukitsimen poistaminen

1. Irrota luukun lukitsimen pistotulppa.
2. Vapauta luukun lukitsin.



3. Poista luukun lukitsin.





4.8.2 Luukun lukitsimen asennus

Luukun lukitsimen on oltava oikeassa asennossa, jotta koneen luukun hätäavaustoiminto on mahdollinen.



- ▶ Asenna vastakkaisessa järjestyksessä.

4.9 Rummun lampun vaihtaminen

	⚠ HUOMAA Terävät kotelon reunat! Viiltovammat ▶ Käytä suojakäsineitä.
	⚠ VAROITUS Kallistetun koneen luiskahtaminen! Luunmurtumat/murskavammat ▶ Estä koneiden luiskahtaminen.
	⚠ HUOMAA Ruuvien avaamisesta aiheutuva osien putoamisen riski! Loukkaantuminen putoavien osien vuoksi. ▶ Estä komponentin putoaminen.
	⚠ HUOMIO! Ruuvien avaamisesta aiheutuva osien putoamisen riski! Vauriot koneen muille osille tai asiakkaan kodille, esim. lattia. ▶ Estä komponentin putoaminen.

Vaatus:

- ✔ Kone on erotettu teholähteestä.
- ✔ Kone on erotettu vedenjakelusta.
- ✔ Koneeseen on vapaa pääsy.
- ✔ [Työtaso on poistettu.→161](#)
- ✔ [Pesuainelokero on poistettu.→163](#)
- ✔ Ohjauspaneeli on poistettu.

4.9.1 Rummun lampun poistaminen

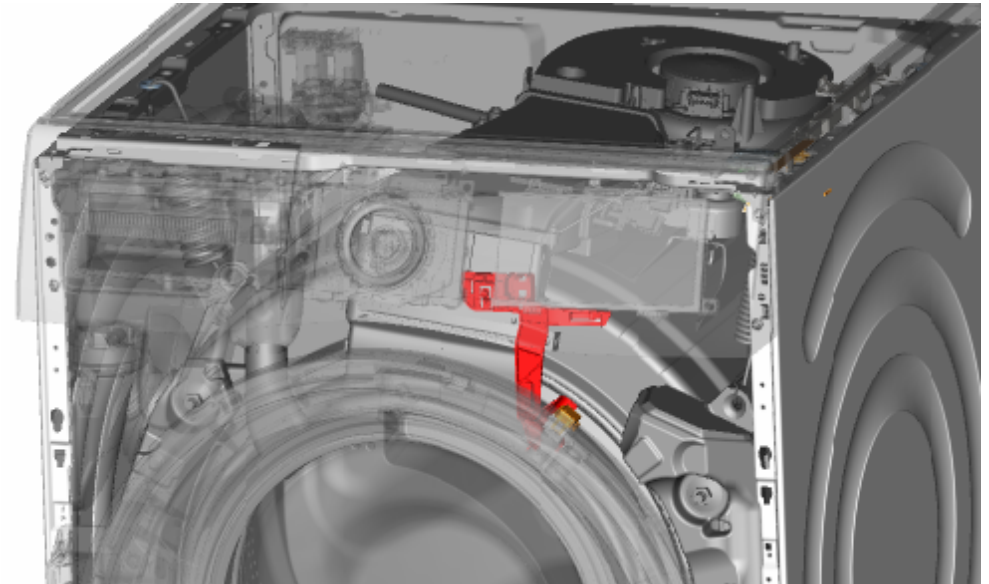

1. Vedä rummun lamppupidike ulos koneesta.
2. Irrota sähköliitännät.
3. Poista lamppu rummun lampunpidikkeestä.

4.9.2 Rummun lampun asennus

- ▶ Asenna vastakkaisessa järjestyksessä.

4.10 Pumpun suojuksen vaihtaminen

Vaatus:

- ✔ Kone on erotettu teholähteestä.
- ✔ Kone on erotettu vedenjakelusta.

4.10.1 Pumpun suojuksen poistaminen

1. Avaa pumpun suojus.

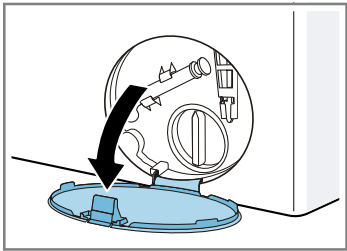

2. Poista pumpun suojus.

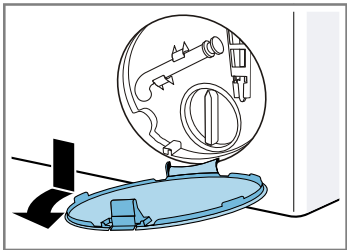

4.10.2 Pumpun suojuksen asennus

- ▶ Asenna vastakkaisessa järjestyksessä.

4.11 Etupaneelin vaihtaminen



⚠ HUOMAA

Terävät kotelon reunat!
Viiltovammat
► Käytä suojakäsineitä.

Vaatus:

- ✓ Kone on erotettu teholahteesta.
- ✓ Kone on erotettu vedenjakelusta.
- ✓ [Pesuainelokero on poistettu.→163](#)
- ✓ [Luukku on poistettu.→165](#)
- ✓ Luukun tiiviste on poistettu.
- ✓ [Pumpun suojus on poistettu.→174](#)

4.11.1 Etupaneelin poistaminen

1.



⚠ VAROITUS

Kallistetun koneen luiskahtaminen.!
Luunmurtumat/murskavammat
► Estä koneiden luiskahtaminen.

Nosta konetta ylös edestä.

2. Poista ruuvit alaosasta (1).

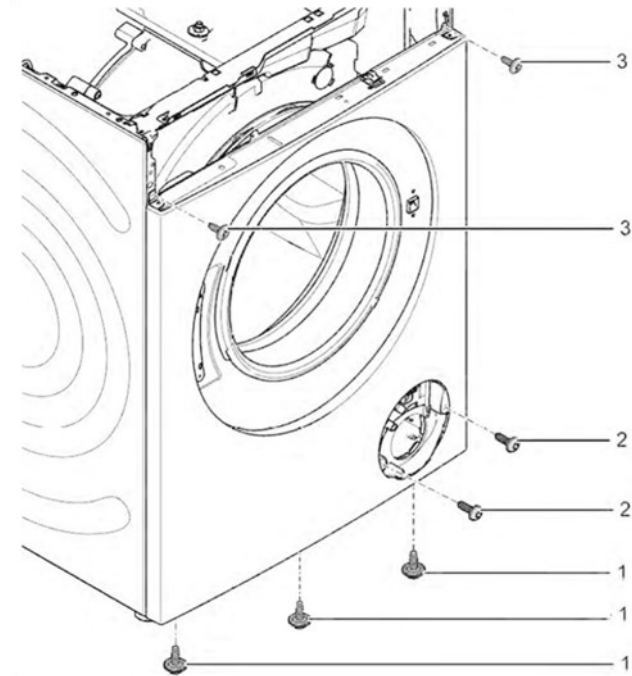

3. Laske kone alas.

4. 1. Poista ruuvit (1).
2. Työnnä työtaso koneen takaosaan (2).
3. Nosta työtasoa ylös (3) ja poista se.

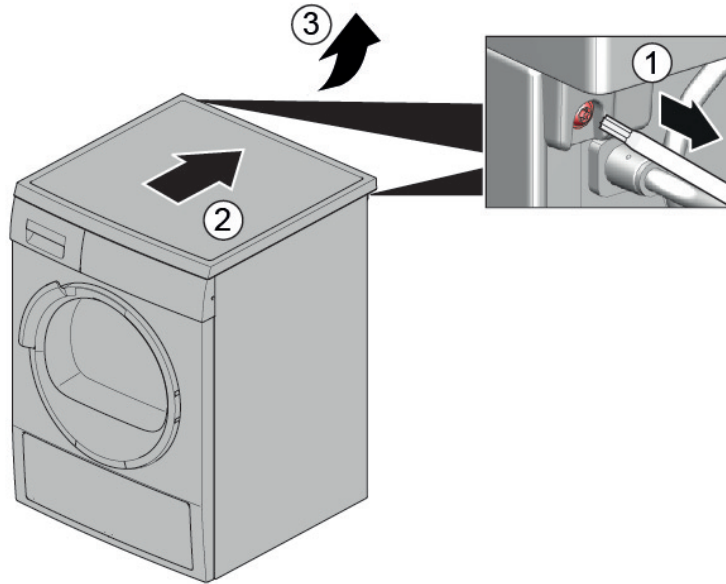

5. 1. Poista ruuvit (1).
2. Vapauta lukitusosat (2, 3).

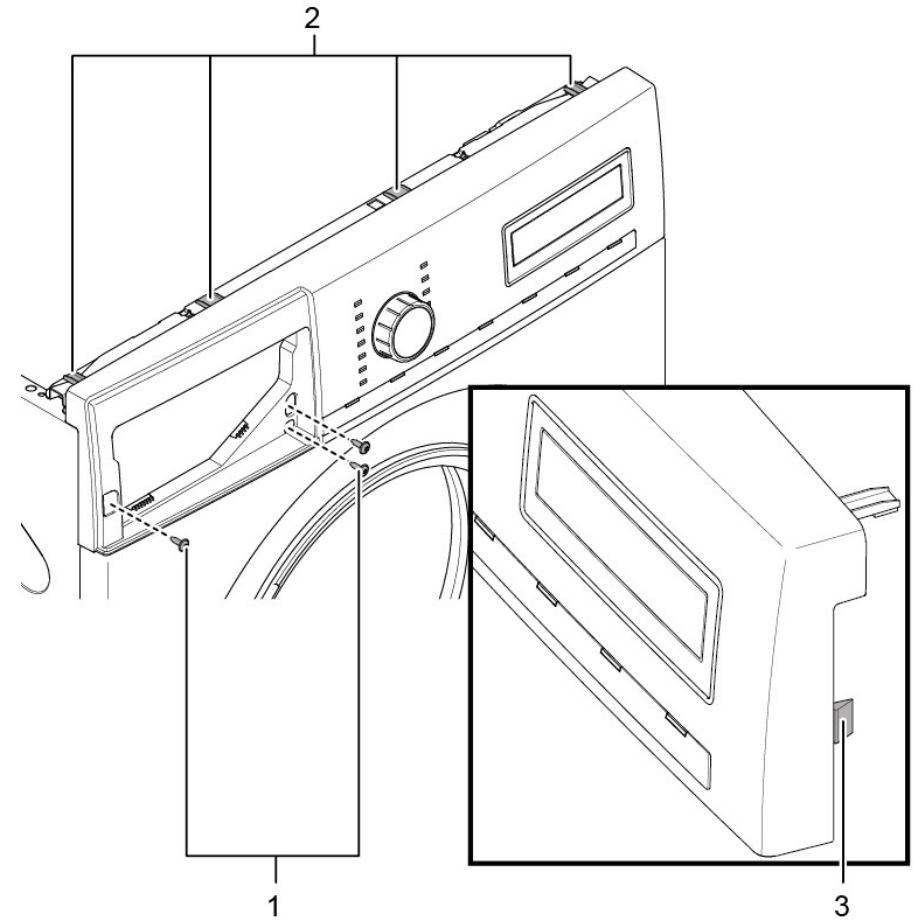

6. Poista ohjauspaneeli.

7.



⚠ HUOMAA

Ruuvien avaamisesta aiheutuva osien putoamisen riski!
Loukkaantuminen putoavien osien vuoksi.
▶ Estä komponentin putoaminen.



HUOMIO!

Ruuvien avaamisesta aiheutuva osien putoamisen riski!
Vauriot koneen muille osille tai asiakkaan kodille, esim. lattia.
► Estä komponentin putoaminen.

Poista ruuvit edestä etenemällä alhaalta ylöspäin (2, 3).

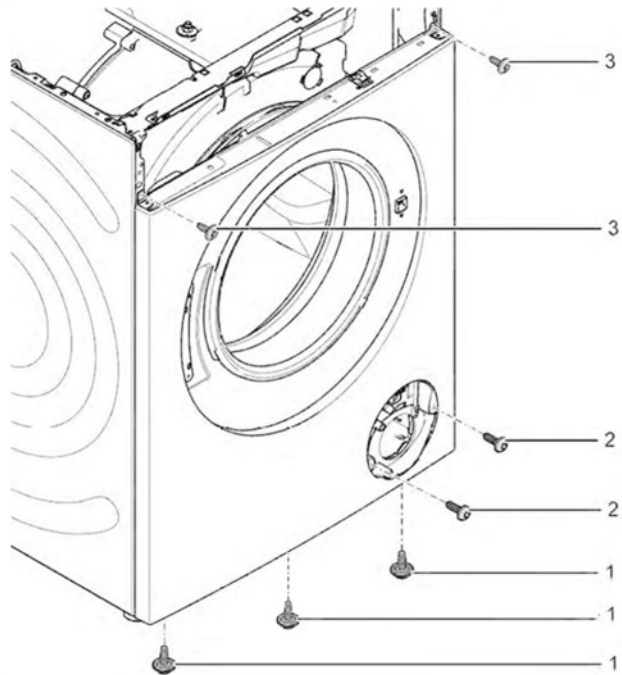

8. Poista etupaneeli.

4.11.2 Etupaneelin asentaminen

► Asenna vastakkaisessa järjestyksessä.

Conseils de réparation - Lave-linge

A propos de ce document..... 179

1.1 Informations importantes.....	179
1.1.1 Objectif.....	179
1.2 Explication des symboles.....	179
1.2.1 Niveaux de risque.....	179
1.2.2 Symboles de danger.....	179
1.2.3 Structure des indications d'avertissement.....	180
1.2.4 Symboles généraux.....	180

Sécurité..... 181

2.1 Consignes de sécurité générales.....	181
2.1.1 Tous les appareils électroménagers.....	181

Outils et aides..... 182

Réparation 183

4.1 Changer le dessus.....	183
4.1.1 Retirer le dessus.....	183
4.1.2 Monter le dessus.....	183
4.2 Changer le panneau de commande.....	184
4.2.1 Retirer le panneau de commande.....	184
4.2.2 Monter le panneau de commande.....	184
4.3 Changer le bac à produits.....	185
4.3.1 Retirer le bac à produits.....	185
4.3.2 Monter le bac à produits.....	185
4.4 Changer la poignée du bac à produits.....	186
4.4.1 Retirer la poignée du bac à produits.....	186
4.4.2 Monter la poignée du bac à produits.....	186
4.5 Changer la porte.....	187
4.5.1 Retirer la porte.....	187
4.5.2 Monter la porte.....	187
4.6 Changer les composants de la porte.....	188
4.6.1 Retirer les composants de la porte.....	188
4.6.2 Monter les composants de la porte.....	188
4.7 Changer le joint de porte.....	189
4.7.1 Retirer le joint de porte.....	189
4.7.2 Monter le joint de porte.....	192

4.8 Echange de la fermeture de porte.....	193
4.8.1 Retrait de la fermeture de porte.....	193
4.8.2 Monter la fermeture de porte.....	194
4.9 Changer la lumière du tambour.....	195
4.9.1 Retirer la lumière du tambour.....	195
4.9.2 Monter la lumière du tambour.....	195
4.10 Changer le couvercle de la pompe.....	196
4.10.1 Retirer le couvercle de la pompe.....	196
4.10.2 Monter le couvercle de la pompe.....	196
4.11 Changer le panneau de façade.....	197
4.11.1 Retirer le panneau de façade.....	197
4.11.2 Monter le panneau de façade.....	199

i A propos de ce document

1.1 Informations importantes

1.1.1 Objectif

Les conseils de réparation qui suivent aident le consommateur à réparer l'appareil par lui-même, conformément au règlement sur l'écoconception (en vigueur en 03/2021).

Ils contiennent des informations sur l'échange de certaines pièces détachées, ainsi que des avertissements et risques.

Pour toute question, veuillez contacter notre service après-vente. Nous ne serons responsables des dommages que si les indications de réparation ont été suivies correctement.

1.2 Explication des symboles

1.2.1 Niveaux de risque

Les niveaux de risque se composent d'un symbole et d'un terme d'avertissement. Le mot d'avertissement caractérise la gravité du danger.









Niveau de dangerosité	Signification
 DANGER	Le non respect de la consigne d'avertissement provoque la mort ou des blessures graves.
 AVERTISSEMENT	Le non respect de la consigne d'avertissement peut provoquer la mort ou des blessures graves.
 PRUDENCE	Le non respect de la consigne d'avertissement peut provoquer des blessures légères.
 ATTENTION !	Le non respect de la consigne d'avertissement peut provoquer des dégâts matériels.

Tableau 1: Niveaux de risque

1.2.2 Symboles de danger

Les symboles de danger sont des représentations figuratives renseignant sur la nature du danger.

Ce document utilise les symboles de danger suivants:

Symbole de danger	Signification
	Consigne d'avertissement générale
	Danger engendré par la tension électrique
	Risque d'explosion
	Risque de blessures par coupure

i A propos de ce document





Symbole de danger	Signification
	Risque de blessures par écrasement
	Danger engendré par des surfaces très chaudes
	Danger engendré par un champ magnétique puissant
	Danger engendré par un rayonnement non ionisant

Tableau 2: Symboles de danger

1.2.3 Structure des indications d'avertissement

Les consignes d'avertissement figurant dans ce document ont un aspect uniforme et une structure uniforme.

	<div style="background-color: red; color: white; padding: 2px; text-align: center;">⚠ DANGER</div> <p>Type et source du danger ! Conséquences possibles en cas de non-respect du danger / de l'avertissement.</p> <ul style="list-style-type: none"> ▶ Mesures et interdictions pour éviter le danger.
--	---

L'exemple suivant montre une consigne d'avertissement mettant en garde contre le risque d'électrocution. La mesure permettant d'éviter le danger est nommée.

	<div style="background-color: red; color: white; padding: 2px; text-align: center;">⚠ DANGER</div> <p>Risque d'électrocution par des pièces conductrices de tension ! Mort par électrocution.</p> <ul style="list-style-type: none"> ▶ Débrancher l'appareil du secteur minimum 60 secondes avant de démarrer la réparation.
--	---

1.2.4 Symboles généraux

Ce document utilise les symboles généraux suivants:











Symbole général	Signification
	Caractérisation d'une astuce particulière (texte et/ou graphique)
	Caractérisation d'une astuce simple (texte seul)
	Caractérisation d'un lien vers une vidéo
	Caractérisation d'outils nécessaires
	Caractérisation de conditions nécessaires
	Caractérisation d'une condition (si... , alors ...)
	Caractérisation d'un résultat
	Caractérisation d'une touche ou surface de commande
	Caractérisation d'une référence de pièce
	Caractérisation d'un texte affiché / fenêtre (sur l'afficheur)

Tableau 3: Symboles généraux

2.1 Consignes de sécurité générales

2.1.1 Tous les appareils électroménagers

Risque d'électrocution en raison de pièces sous tension!

- Des erreurs lors de réparations impliquant des composants électriques peuvent entraîner une décharge électrique!
- Débrancher l'appareil du secteur minimum 60 secondes avant de démarrer la réparation.
- Après la réparation, effectuer un test de sécurité selon VDE 0701 ou les réglementations spécifiques nationales.

Risque de blessures par coupure sur des bords tranchants!

- Porter des gants de protection.

Risque de casse durant la réparation, maintenance, dépannage et SAV en raison de composants lourds et mobiles

- Porter des chaussures de protection.
- Sécuriser les composants lourds contre le risque de chute.
- Ne pas coller les pièces du châssis sur les composants mobiles.







Risque lié à la sécurité / fonction de l'appareil!

- Utiliser uniquement des pièces détachées d'origine.

Risque d'endommagement des composants sensibles aux décharges électrostatiques!

- Ne pas toucher les modules, ni leur connexions et pistes conductrices.

Outils et aides

Désignation	Détails	Images
Outil auxiliaire [15000155]	Cale de montage pour démonter les pièces en plastique	
Tournevis Torx T20 avec perçage [00340764]	100 mm , pour les vis avec la tige de sécurité	
Clé dynamométrique [15000441]	Clé dynamométrique 20 - 100 Nm	
Tournevis plat [00340854]	Lame 3.5 mm x 0.6 mm x 100 mm, Isolation de protection 1000 V AC	
Tournevis plat [00340855]	Lame 5.5 mm x 1.0 mm x 125 mm, isolation de protection 1000 V AC	
Pince à bec fin, angulaire [00341269]	Longueur 200 mm	
Pince coupante [00342182]	Longueur: 200 mm	



Désignation	Détails	Images
Clé mixte [00340811]	Taille de la clé 10°mm, M6	
Combinaison wrench [00340814]	Taille de la clé 13°mm, M8	
Clé mixte [00340817]	Taille de la clé 17 mm, M10	
Clé mixte [15000459]	Taille de la clé 16°mm, M10	

4.1 Changer le dessus

Outillage nécessaire:

-  Embout tournevis Torx TX20 6.3°mm (1/4") 152°mm, pour vis avec [00341272] avec trou, long axe de sécurité

Pré-requis:

-  Appareil n'est pas sous tension.
-  L'appareil n'est pas connecté à une alimentation en eau.

4.1.1 Retirer le dessus

- ▶ 1. Retirer les vis (1).
- ▶ 2. Repousser le dessus vers l'arrière l'appareil (2).
- ▶ 3. Soulever le dessus (3) pour le retirer.

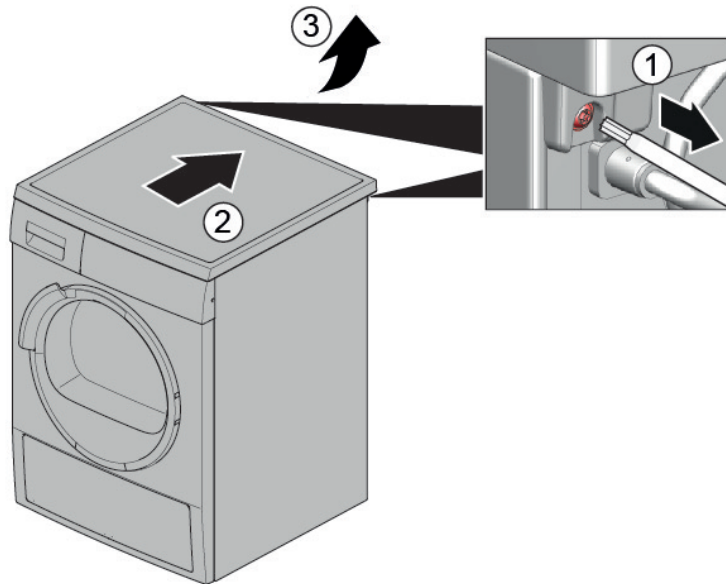

4.1.2 Monter le dessus

- ▶ Le montage s'effectue dans l'ordre chronologique inverse.

4.2 Changer le panneau de commande



⚠️ PRUDENCE

Bords tranchants du boîtier !
Risque de coupures!
▶ Porter des gants de protection.



⚠️ AVERTISSEMENT

Chute d'appareils inclinés !
Fractures/blessures d'écrasement
▶ Sécuriser les appareils contre le risque de chute.



⚠️ PRUDENCE

Risque de pièces qui chutent en raison de vis trop lâches !
Blessures dues à des pièces qui chutent.
▶ Sécuriser les composants contre le risque de chute.



⚠️ ATTENTION !

Risque de pièces qui chutent en raison de vis trop lâches !
Dommages à d'autres parties de l'appareil ou à la propriété du client, p. ex. au plancher.
▶ Sécuriser les composants contre le risque de chute.

Pré-requis:

- ✔ Appareil n'est pas sous tension.
- ✔ L'appareil n'est pas connecté à une alimentation en eau.
- ✔ [Dessus a été retiré. → 183](#)
- ✔ [Bac à produits retiré. → 185](#)

4.2.1 Retirer le panneau de commande

1. 1. Retirer les vis (1).
2. 2. Retirer les éléments de fixation (2, 3).

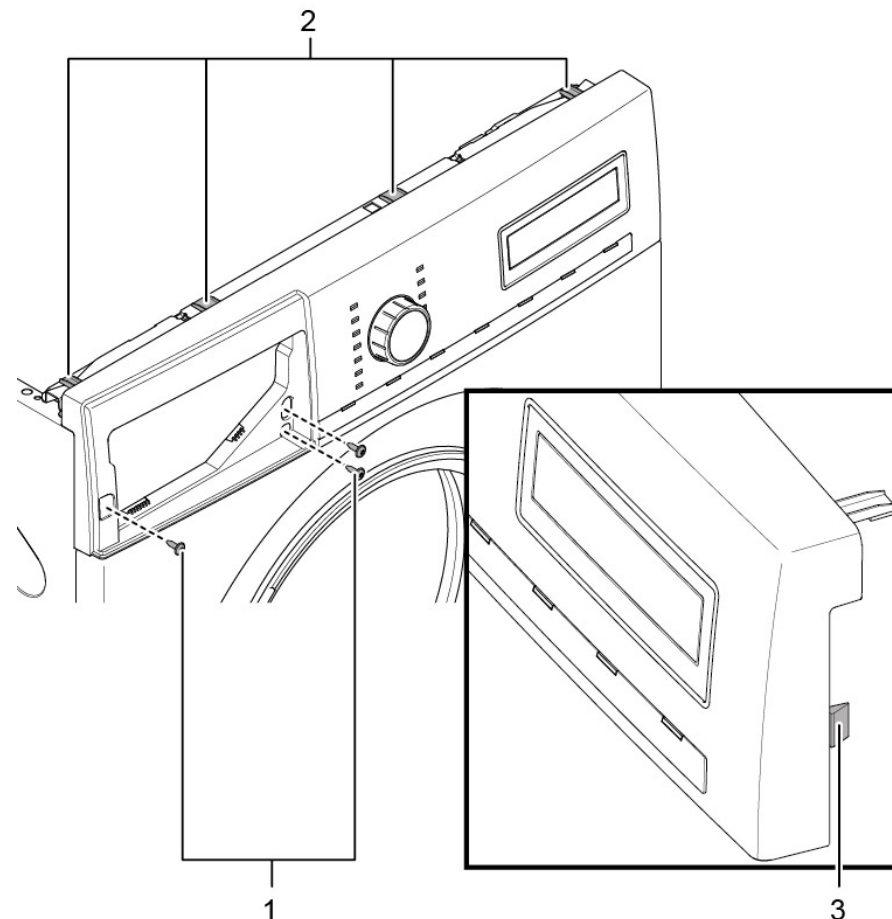

2. 2. Relâcher le contact à fiche de l'unité de commande.
3. 3. Retirer le panneau de commande.

4.2.2 Monter le panneau de commande

- ▶ Le montage s'effectue dans l'ordre chronologique inverse.

4.3 Changer le bac à produits

Pré-requis:

- ✓ Appareil n'est pas sous tension.
- ✓ L'appareil n'est pas connecté à une alimentation en eau.

4.3.1 Retirer le bac à produits

1. Ouvrir le bac à produits.
2. 1. Appuyer dessus pour l'insérer (1).
2. Retirer le bac à produits (2).

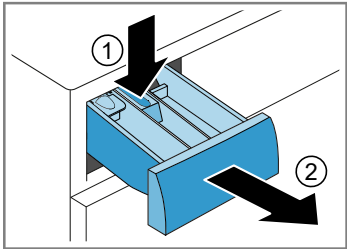

4.3.2 Monter le bac à produits

- ▶ Le montage s'effectue dans l'ordre chronologique inverse.

4.4 Changer la poignée du bac à produits

Pré-requis:

- ✓ Appareil n'est pas sous tension.
- ✓ L'appareil n'est pas connecté à une alimentation en eau.
- ✓ [Bac à produits retiré. → 185](#)

4.4.1 Retirer la poignée du bac à produits

1. Retirer les éléments de fixation.

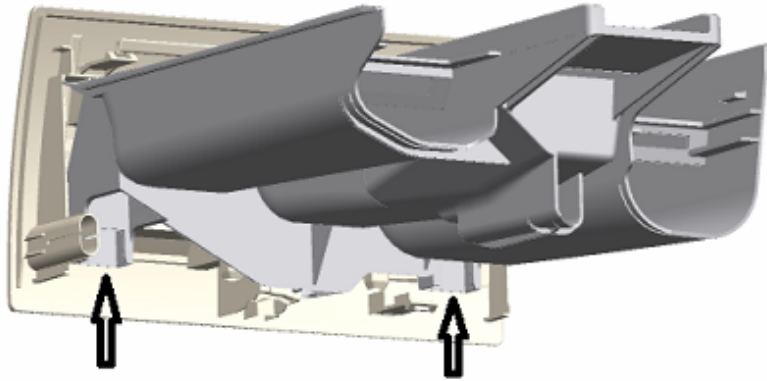

2. Retirer la poignée du bac à produits.

4.4.2 Monter la poignée du bac à produits

- ▶ Le montage s'effectue dans l'ordre chronologique inverse.

4.5 Changer la porte



PRUDENCE

Ouvrir la zone de charnière !

Écrasement/coincement des doigts

- ▶ Ne pas insérer les doigts dans la zone de la charnière.
- ▶ Porter des gants de protection.

Pré-requis:

- ✓ Appareil n'est pas sous tension.
- ✓ L'appareil n'est pas connecté à une alimentation en eau.
- ✓ La porte est ouverte.

4.5.1 Retirer la porte

1.



ATTENTION !

Risque de pièces qui chutent en raison de vis trop lâches !

Domages à d'autres parties de l'appareil ou à la propriété du client, p. ex. au plancher.

- ▶ Sécuriser les composants contre le risque de chute.



PRUDENCE

Risque de pièces qui chutent en raison de vis trop lâches !

Blessures dues à des pièces qui chutent.

- ▶ Sécuriser les composants contre le risque de chute.

Retirer les vis (1).

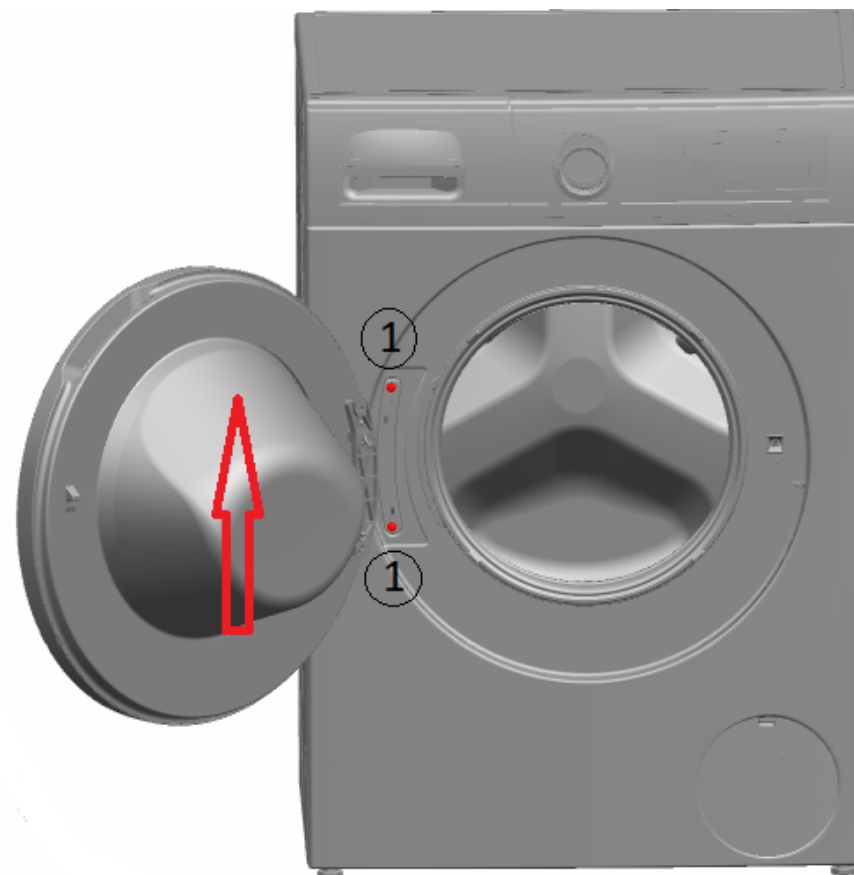

2. Retirer la porte en la soulevant.

4.5.2 Monter la porte

- ▶ Le montage s'effectue dans l'ordre chronologique inverse.

4.6 Changer les composants de la porte



PRUDENCE

Ouvrir la zone de charnière !

Écrasement/coincement des doigts

- ▶ Ne pas insérer les doigts dans la zone de la charnière.
- ▶ Porter des gants de protection.

Pré-requis:

- ✓ Appareil n'est pas sous tension.
- ✓ L'appareil n'est pas connecté à une alimentation en eau.
- ✓ [Porte a été retirée.→187](#)

4.6.1 Retirer les composants de la porte

- ▶ Démonter la porte de l'extérieur vers l'intérieur.

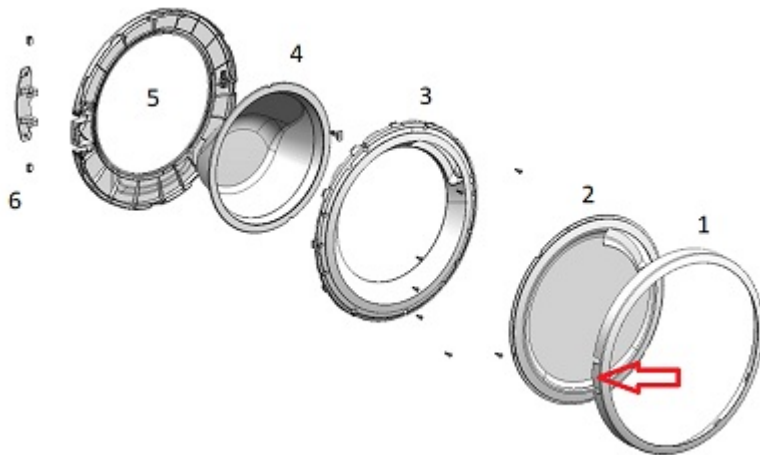

4.6.2 Monter les composants de la porte

- ▶ Le montage s'effectue dans l'ordre chronologique inverse.

4.7 Changer le joint de porte



⚠️ PRUDENCE

Bords tranchants du boîtier !
 Risque de coupures!
 ▶ Porter des gants de protection.



⚠️ PRUDENCE

Risque de pièces qui chutent en raison de vis trop lâches !
 Blessures dues à des pièces qui chutent.
 ▶ Sécuriser les composants contre le risque de chute.



ATTENTION !

Risque de pièces qui chutent en raison de vis trop lâches !
 Dommages à d'autres parties de l'appareil ou à la propriété du client, p. ex. au plancher.
 ▶ Sécuriser les composants contre le risque de chute.

Pré-requis:

- ✓ Appareil n'est pas sous tension.
- ✓ L'appareil n'est pas connecté à une alimentation en eau.
- ✓ [Bac à produits retiré. → 185](#)
- ✓ [Porte a été retirée. → 187](#)
- ✓ [Couvercle de la pompe a été retiré. → 196](#)

4.7.1 Retirer le joint de porte

1.



⚠️ AVERTISSEMENT

Chute d'appareils inclinés !
 Fractures/blessures d'écrasement
 ▶ Sécuriser les appareils contre le risque de chute.

Soulever l'appareil par l'avant.

2. Desserrer les vis dans la portion inférieure du panneau de façade (1).

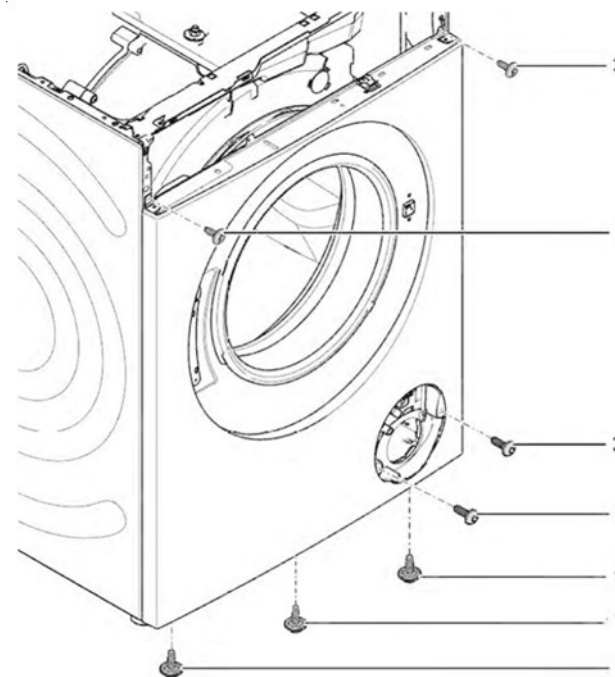

3. Abaisser l'appareil.

Réparation

4. Retirer les vis dans la zone de la pompe (2).

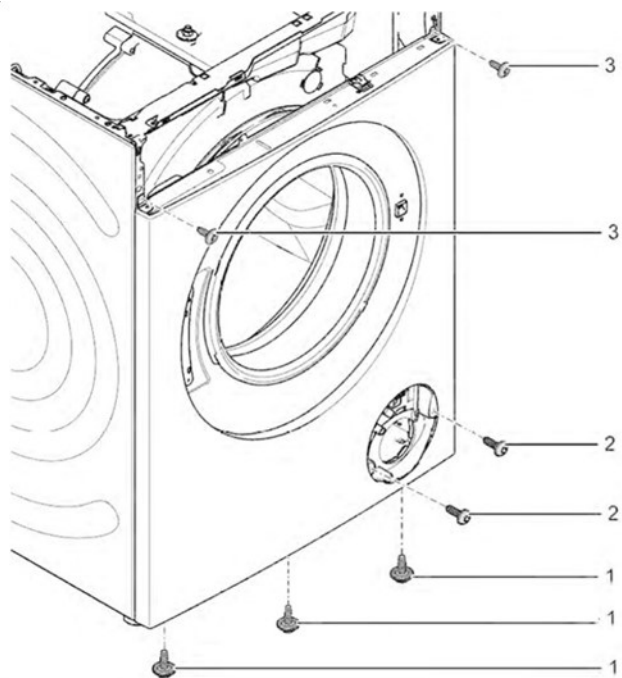

5. 1. Desserrer les vis à l'arrière de l'appareil (1).
2. Retirer le dessus (2, 3).

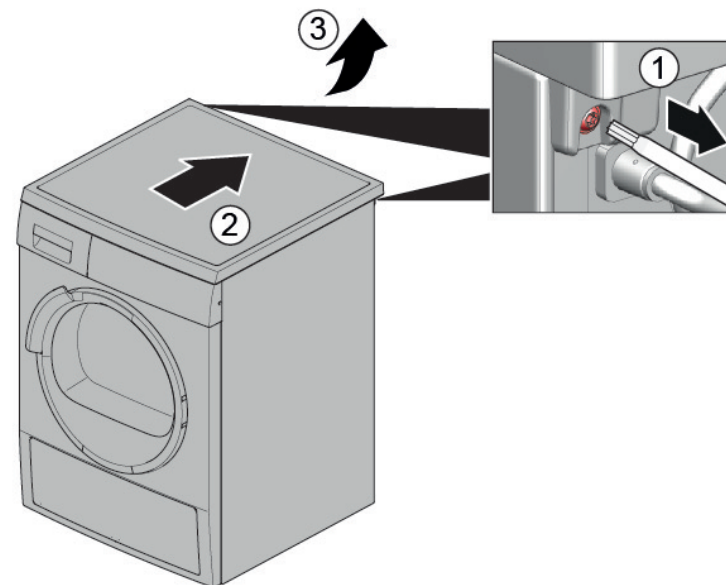

Réparation

6. 1. Retirer les vis (1).
2. Relâcher les éléments de fixation du panneau (2, 3).
3. Desserrer les vis du boîtier du distributeur.

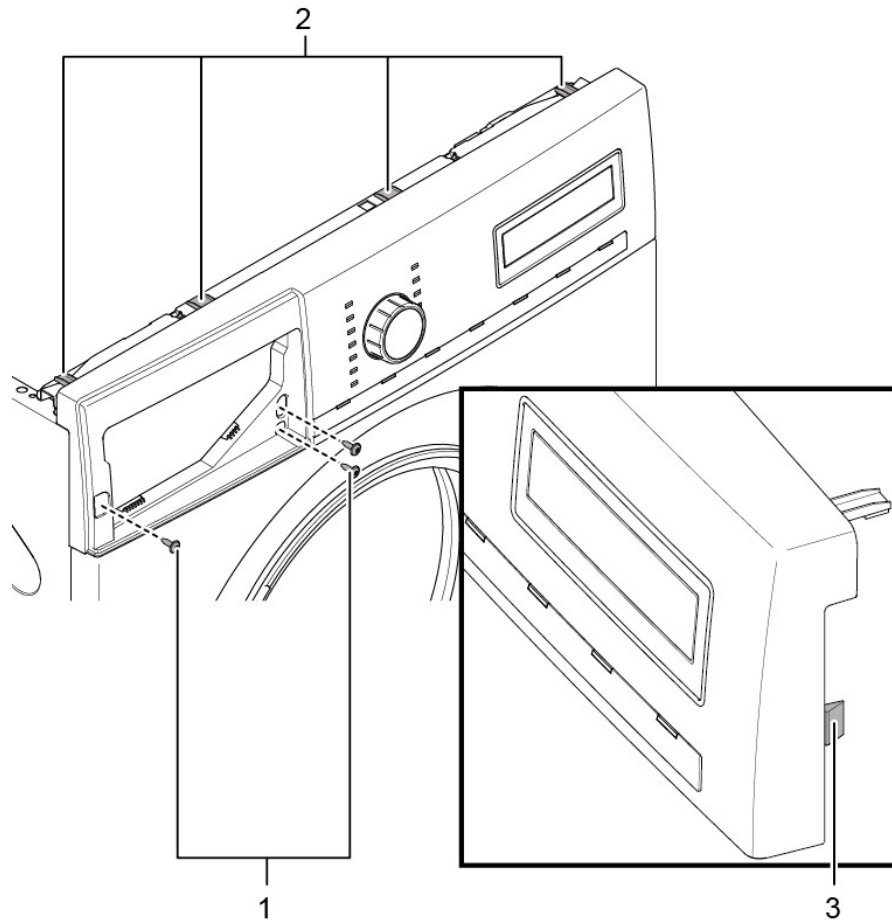

7. Retirer le panneau de commande.

8. Retirer le support de la lumière du tambour en partie supérieure.

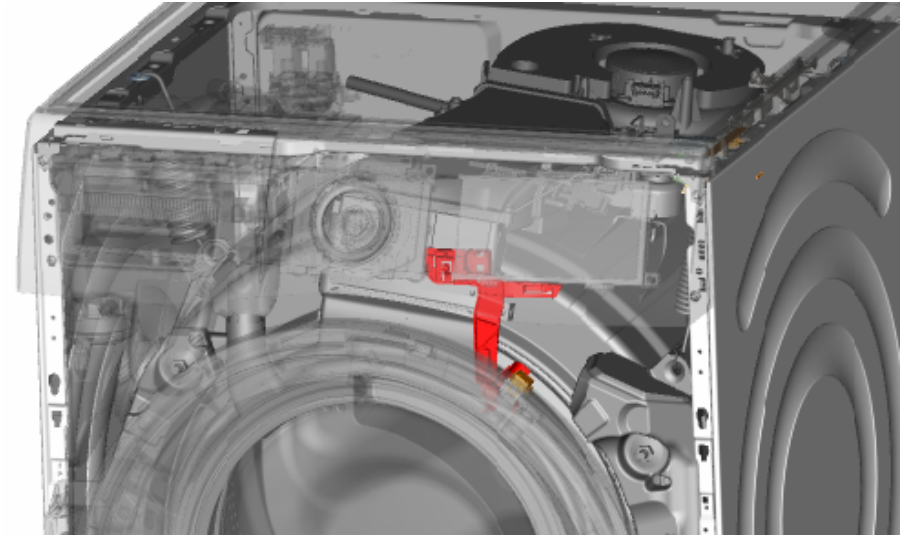

- 9.



ATTENTION !

Risque de dommage superficiel !

La surface de l'appareil peut être rayée par l'utilisation d'outils inadéquats.

- ▶ Remplacer le collier de serrage uniquement avec des outils en plastique.

Retirer le collier de serrage de la manchette avec un outil en plastique.

10. Défaire le joint de porte du panneau de façade.
11. Débrancher le connecteur de câble de la fermeture de porte.

12. Desserrer les vis dans la portion supérieure du panneau de façade (3).

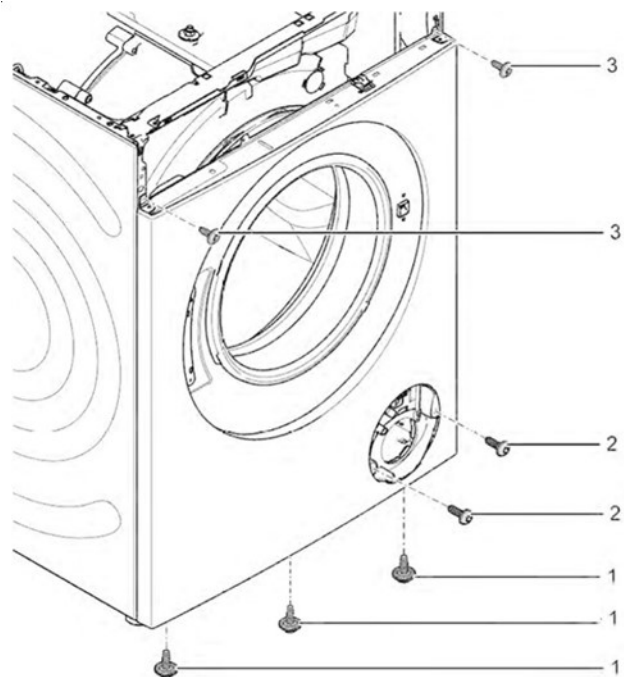

13. Retirer le panneau de façade.

14. Retirer tous les raccords de flexibles.

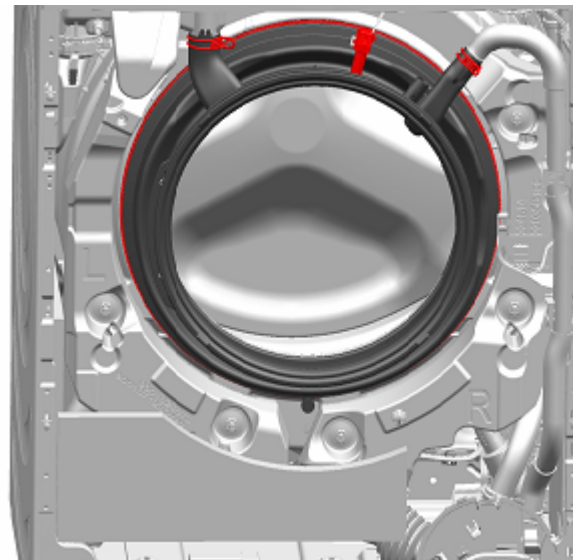

15. Retirer le joint de porte.

4.7.2 Monter le joint de porte



AVERTISSEMENT

Risque de chute de pièces en cas d'installation incorrecte !
Risque de blessure ou endommagement de l'appareil.
▶ Serrer l'anneau de tension du joint de 3,4 Nm.

▶ Le montage s'effectue dans l'ordre chronologique inverse.

4.8 Echange de la fermeture de porte

En tant que fabricant, nous sommes obligés de fournir aux clients la fermeture de porte SAV incluant les instructions de réparation selon la réglementation (EU) 2019/2023. Toutefois, nous aimerions mentionner la nécessité d'effectuer un test électrotechnique par un électricien qualifié, après l'échange d'une fermeture de porte, avant la mise en service de l'appareil. Cette personne doit être qualifiée selon les lois, réglementations et standards nationaux spécifiques, de façon vérifiable.

	⚠ DANGER
	Risque d'électrocution en raison de pièces sous tension ! Risque d'électrocution en cas de réparation non conforme <ul style="list-style-type: none">▶ Les pièces électriques doivent être réparées par des techniciens qualifiés.▶ Après la réparation, effectuer un test de sécurité selon VDE 0701 ou les réglementations spécifiques nationales.

	⚠ PRUDENCE
	Bords tranchants du boîtier ! Risque de coupures! <ul style="list-style-type: none">▶ Porter des gants de protection.

	⚠ AVERTISSEMENT
	Chute d'appareils inclinés ! Fractures/blessures d'écrasement <ul style="list-style-type: none">▶ Sécuriser les appareils contre le risque de chute.

	⚠ PRUDENCE
	Risque de pièces qui chutent en raison de vis trop lâches ! Blessures dues à des pièces qui chutent. <ul style="list-style-type: none">▶ Sécuriser les composants contre le risque de chute.

	ATTENTION !
	Risque de pièces qui chutent en raison de vis trop lâches ! Dommages à d'autres parties de l'appareil ou à la propriété du client, p. ex. au plancher. <ul style="list-style-type: none">▶ Sécuriser les composants contre le risque de chute.

Pré-requis:

- ✓ Appareil n'est pas sous tension.

- ✓ L'appareil n'est pas connecté à une alimentation en eau.
- ✓ L'appareil est librement accessible.
- ✓ [Dessus a été retiré. → 183](#)
- ✓ Panneau de commande a été retiré.
- ✓ [Porte a été retirée. → 187](#)
- ✓ Collier de serrage a été retiré.
- ✓ Panneau de façade a été retiré.
- ✓ Joint de porte a été retiré.

4.8.1 Retrait de la fermeture de porte

1. Débrancher la prise de la fermeture de porte.
2. Défaire la fermeture de porte.



3. Retirer la fermeture de porte.

4.8.2 Monter la fermeture de porte

La fermeture de porte doit être dans la bonne position pour garantir la fonction d'ouverture d'urgence de la porte de l'appareil.

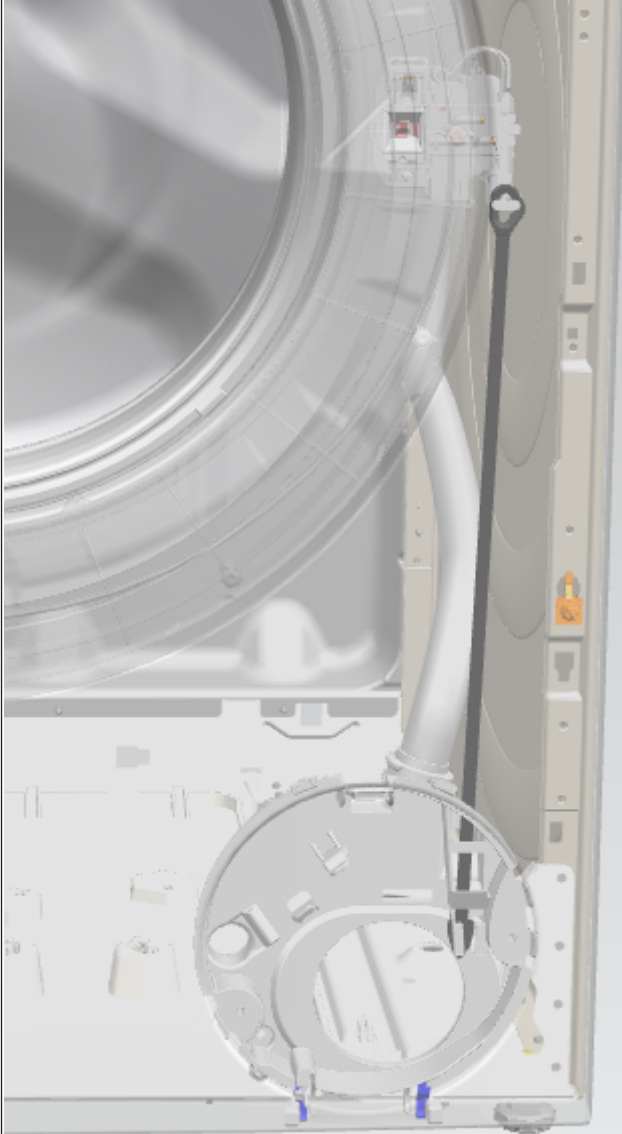

- ▶ Le montage s'effectue dans l'ordre chronologique inverse.

4.9 Changer la lumière du tambour



⚠️ PRUDENCE

Bords tranchants du boîtier !
Risque de coupures!
▶ Porter des gants de protection.



⚠️ AVERTISSEMENT

Chute d'appareils inclinés !
Fractures/blessures d'écrasement
▶ Sécuriser les appareils contre le risque de chute.



⚠️ PRUDENCE

Risque de pièces qui chutent en raison de vis trop lâches !
Blessures dues à des pièces qui chutent.
▶ Sécuriser les composants contre le risque de chute.



⚠️ ATTENTION !

Risque de pièces qui chutent en raison de vis trop lâches !
Dommages à d'autres parties de l'appareil ou à la propriété du client, p. ex. au plancher.
▶ Sécuriser les composants contre le risque de chute.

Pré-requis:

- ✔ Appareil n'est pas sous tension.
- ✔ L'appareil n'est pas connecté à une alimentation en eau.
- ✔ L'appareil est librement accessible.
- ✔ [Dessus a été retiré. → 183](#)
- ✔ [Bac à produits retiré. → 185](#)
- ✔ Panneau de commande a été retiré.

4.9.1 Retirer la lumière du tambour

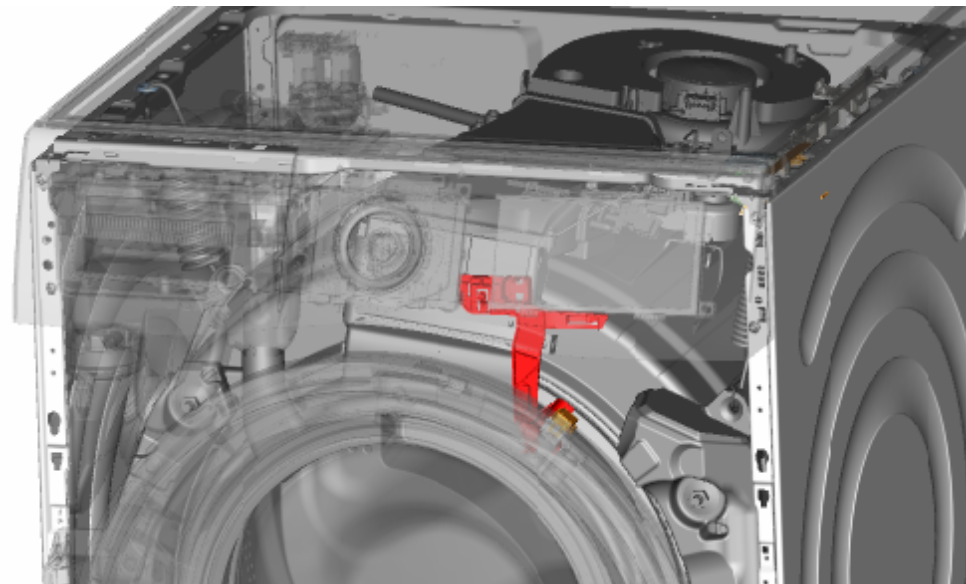

1. Sortir le support de la lumière du tambour de l'appareil.
2. Débrancher les connexions électriques.
3. Retirer la lumière du tambour de son support.

4.9.2 Monter la lumière du tambour

- ▶ Le montage s'effectue dans l'ordre chronologique inverse.

4.10 Changer le couvercle de la pompe

Pré-requis:

- ✓ Appareil n'est pas sous tension.
- ✓ L'appareil n'est pas connecté à une alimentation en eau.

4.10.1 Retirer le couvercle de la pompe

1. Ouvrir le couvercle de la pompe.

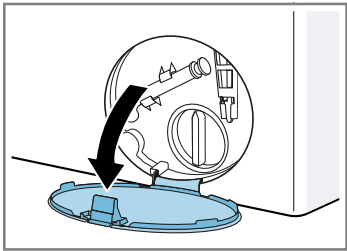

2. Retirer le couvercle de la pompe.

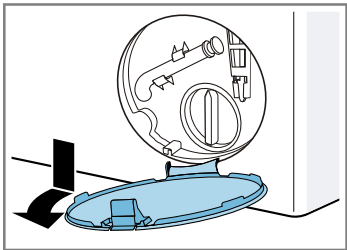

4.10.2 Monter le couvercle de la pompe

- ▶ Le montage s'effectue dans l'ordre chronologique inverse.

4.11 Changer le panneau de façade



⚠️ PRUDENCE

Bords tranchants du boîtier !
Risque de coupures!
▶ Porter des gants de protection.

Pré-requis:

- ✓ Appareil n'est pas sous tension.
- ✓ L'appareil n'est pas connecté à une alimentation en eau.
- ✓ [Bac à produits retiré. → 185](#)
- ✓ [Porte a été retirée. → 187](#)
- ✓ Joint de porte a été retiré.
- ✓ [Couvercle de la pompe a été retiré. → 196](#)

4.11.1 Retirer le panneau de façade

1.



⚠️ AVERTISSEMENT

Chute d'appareils inclinés !
Fractures/blessures d'écrasement
▶ Sécuriser les appareils contre le risque de chute.

Soulever l'appareil par l'avant.

2. Retirer les vis dans la portion inférieure (1).

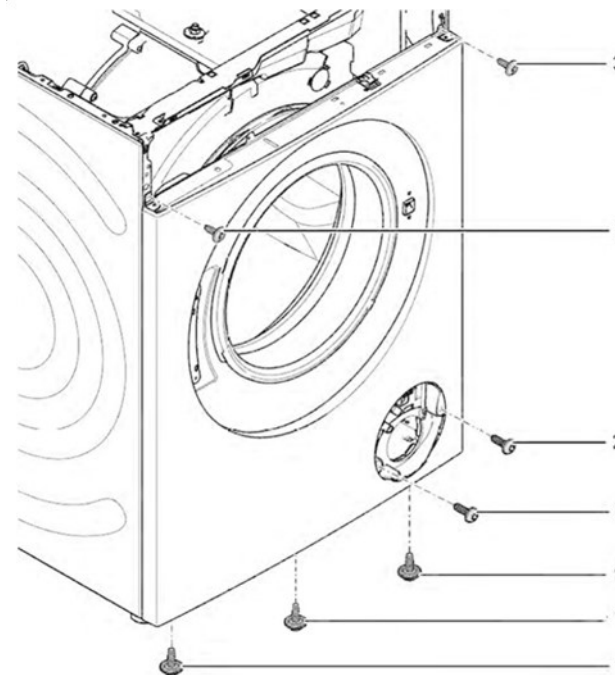

3. Abaisser l'appareil.

Réparation

4. 1. Retirer les vis (1).
2. Repousser le dessus vers l'arrière l'appareil (2).
3. Soulever le dessus (3) pour le retirer.

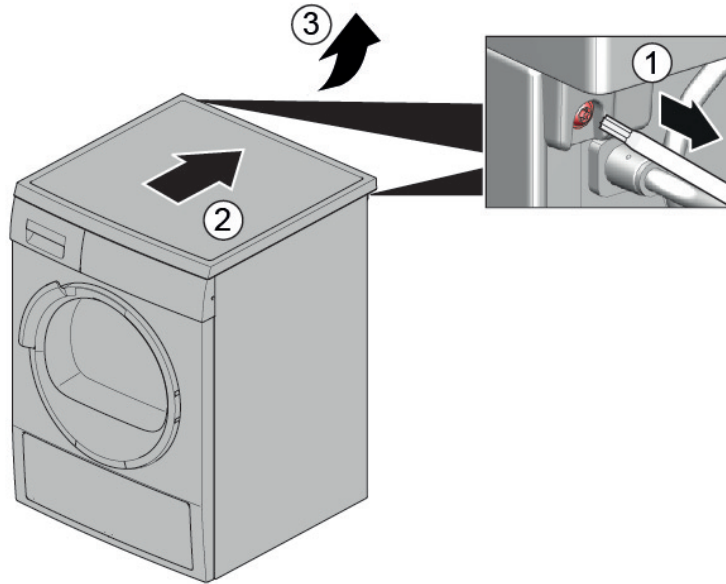

5. 1. Retirer les vis (1).
2. Retirer les éléments de fixation (2, 3).

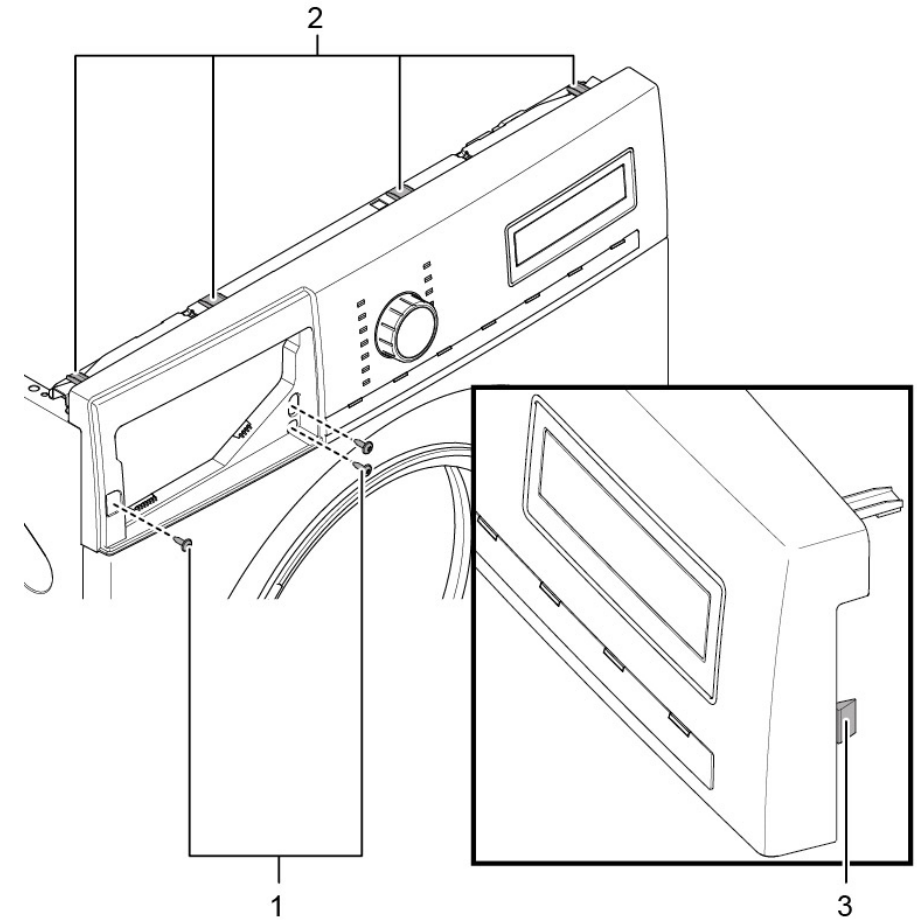

6. Retirer le panneau de commande.

7.



PRUDENCE

Risque de pièces qui chutent en raison de vis trop lâches !

Blessures dues à des pièces qui chutent.

- ▶ Sécuriser les composants contre le risque de chute.



ATTENTION !

Risque de pièces qui chutent en raison de vis trop lâches !
Dommages à d'autres parties de l'appareil ou à la propriété du client, p. ex. au plancher.
▶ Sécuriser les composants contre le risque de chute.

Retirer les vis à l'avant à partir du bas (2, 3).

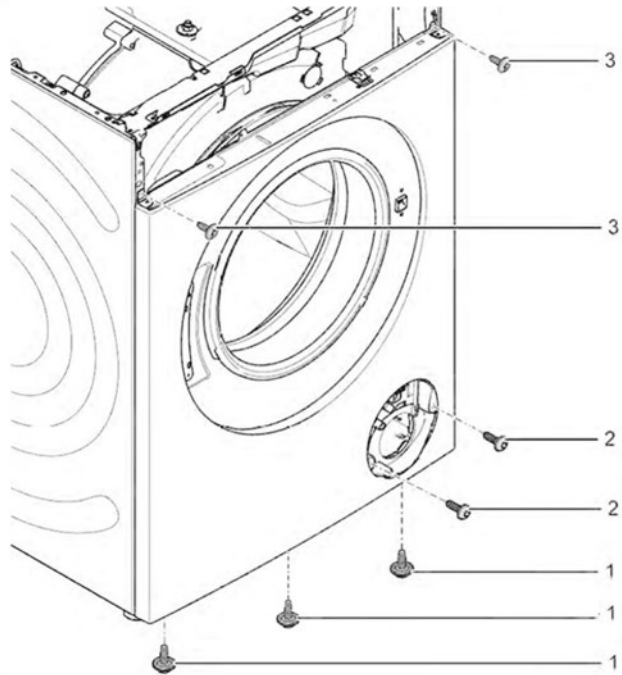

8. Retirer le panneau de façade.

4.11.2 Monter le panneau de façade

▶ Le montage s'effectue dans l'ordre chronologique inverse.

Reparatur Hinweise - Waschmaschine

Zu diesem Dokument..... 201

1.1	Wichtige Hinweise:	201
1.1.1	Zweck	201
1.2	Zeichenerklärung	201
1.2.1	Gefahrenstufen	201
1.2.2	Gefahrensymbole	201
1.2.3	Struktur der Warnhinweise	202
1.2.4	Allgemeine Symbole	202

Sicherheit..... 203

2.1	Allgemeine Sicherheitshinweise	203
2.1.1	Alle Hausgeräte	203

Werkzeuge und Hilfsmittel..... 204

Instandsetzen 205

4.1	Arbeitsplatte tauschen	205
4.1.1	Arbeitsplatte demontieren	205
4.1.2	Arbeitsplatte montieren	205
4.2	Austauschen der Bedienblende	206
4.2.1	Ausbauen der Bedienblende	206
4.2.2	Einbauen der Bedienblende	206
4.3	Austauschen der Waschmittelschublade	207
4.3.1	Ausbauen der Waschmittelschublade	207
4.3.2	Einbauen der Waschmittelschublade	207
4.4	Austauschen des Griffs der Waschmittelschublade	208
4.4.1	Ausbauen des Griffs der Waschmittelschublade	208
4.4.2	Einbauen des Griffs der Waschmittelschublade	208
4.5	Tür austauschen	209
4.5.1	Ausbauen der Tür	209
4.5.2	Einbauen der Tür	209
4.6	Austauschen der Türkomponenten	210
4.6.1	Ausbauen der Türkomponenten	210
4.6.2	Einbauen der Türkomponenten	210
4.7	Austauschen der Türdichtung	211
4.7.1	Ausbauen der Türdichtung	211
4.7.2	Einbauen der Türdichtung	214

4.8	Austauschen der Türverriegelung	215
4.8.1	Türverriegelung demontieren	215
4.8.2	Türverriegelung montieren	216
4.9	Austauschen der Trommelbeleuchtung	217
4.9.1	Ausbauen der Trommelbeleuchtung	217
4.9.2	Einbauen der Trommelbeleuchtung	217
4.10	Austauschen der Pumpenabdeckung	218
4.10.1	Ausbauen der Pumpenabdeckung	218
4.10.2	Einbauen der Pumpenabdeckung	218
4.11	Austauschen der Frontblende	219
4.11.1	Ausbauen der Frontblende	219
4.11.2	Einbauen der Frontblende	221

Zu diesem Dokument

1.1 Wichtige Hinweise:

1.1.1 Zweck

Diese Reparaturhinweise dienen zur Unterstützung des Kunden bei der selbständigen Geräte-Reparatur gemäß der entsprechenden Ökodesign-Richtlinie (ab 03/2021).

Sie enthalten Informationen zum Austausch bestimmter Ersatzteile sowie Warn- und Gefahrenhinweise.

Bitte wenden Sie sich in Zweifelsfällen an unseren Kundendienst. Bei nicht ordnungsgemäßer Befolgung der Reparaturhinweise ist die Schadenshaftung ausgeschlossen.

1.2 Zeichenerklärung

1.2.1 Gefahrenstufen

Die Gefahrenstufen bestehen aus einem Symbol und einem Signalwort. Das Signalwort kennzeichnet die Schwere der Gefahr.









Gefahrenstufe	Bedeutung
	Nichtbeachtung des Warnhinweises führt zu Tod oder schweren Verletzungen.
	Nichtbeachtung des Warnhinweises kann zu Tod oder schweren Verletzungen führen.
	Nichtbeachtung des Warnhinweises kann zu leichten Verletzungen führen.
	Nichtbeachtung des Warnhinweises kann zu Sachschäden führen.

Tabelle 1: Gefahrenstufen

1.2.2 Gefahrensymbole

Gefahrensymbole sind sinnbildliche Darstellungen, die einen Hinweis auf die Art der Gefahr geben.

In diesem Dokument werden folgende Gefahrensymbole verwendet:

Gefahrensymbol	Bedeutung
	Allgemeiner Warnhinweis
	Gefahr durch elektrische Spannung
	Gefahr durch Explosion
	Gefahr von Schnittverletzungen
	Gefahr von Quetschverletzungen

i Zu diesem Dokument





Gefahrensymbol	Bedeutung
	Gefahr durch heiße Oberflächen
	Gefahr durch starkes Magnetfeld
	Gefahr durch nicht ionisierende Strahlung

Tabelle 2: Gefahrensymbole

1.2.3 Struktur der Warnhinweise

Warnhinweise haben in diesem Dokument ein einheitliches Aussehen und eine einheitliche Struktur.



	<div style="background-color: red; color: white; padding: 2px; display: inline-block;">⚠ GEFAHR</div> <p>Art und Quelle der Gefahr! Mögliche Folgen bei Nichtbeachtung der Gefahr / des Warnhinweises.</p> <ul style="list-style-type: none"> ▶ Maßnahmen und Verbote zur Vermeidung der Gefahr.
--	---

Das folgende Beispiel zeigt einen Warnhinweis, der vor Stromschlaggefahr durch spannungsführende Teile warnt. Die Maßnahme zur Vermeidung der Gefahr wird genannt.

	<div style="background-color: red; color: white; padding: 2px; display: inline-block;">⚠ GEFAHR</div> <p>Stromschlaggefahr durch spannungsführende Teile! Tod durch Stromschlag</p> <ul style="list-style-type: none"> ▶ Gerät mindestens 60 Sekunden vor Reparaturbeginn vom Netz trennen.
--	--

1.2.4 Allgemeine Symbole

In diesem Dokument werden folgende allgemeine Symbole verwendet:

Allg. Symbol	Bedeutung
	Kennzeichnung eines besonderen (Text und/oder Grafik) Tipps
	Kennzeichnung eines einfachen (nur Text) Tipps

Allg. Symbol	Bedeutung
	Kennzeichnung eines Links zu einer Videoanleitung
	Kennzeichnung erforderlicher Werkzeuge
	Kennzeichnung erforderlicher Voraussetzungen
	Kennzeichnung einer Bedingung (Wenn ..., dann ...)
	Kennzeichnung eines Ergebnisses
[Start]	Kennzeichnung einer Taste oder Schaltfläche
[00123456]	Kennzeichnung einer Materialnummer
Status	Kennzeichnung eines angezeigten Textes / Fensters (im Gerätedisplay)

Tabelle 3: Allgemeine Symbole

2.1 Allgemeine Sicherheitshinweise

2.1.1 Alle Hausgeräte

Stromschlaggefahr durch spannungsführende Teile!

- Wenn elektrische Komponenten fehlerhaft repariert werden, besteht Stromschlaggefahr!
- Das Gerät mindestens 60 Sekunden vor Beginn der Arbeiten vom Netz trennen.
- Nach der Reparatur muss eine Sicherheitsprüfung nach VDE 0701 oder länderspezifischen Vorschriften durchgeführt werden.

Verletzungsgefahr durch scharfe Kanten!

- Schutzhandschuhe tragen.

Quetschgefahr während Reparatur-, Wartungs-, Fehlersuche- und Servicearbeiten durch schwere sich bewegende Bauteile

- Schutzhandschuhe tragen.
- Schwere Bauteile gegen Herabfallen sichern.
- Körperteile nicht in sich bewegende Bauteile stecken.







Gefährdung der Gerätesicherheit/-funktion!





- Ausschließlich Originalersatzteile verwenden.

Gefahr der Beschädigung elektrostatisch gefährdeter Bauteile (elektrostatische Entladungen)!

- Die Module, einschließlich ihrer Anschlüsse und Leiterbahnen, keinesfalls berühren.

Werkzeuge und Hilfsmittel

Bezeichnung	Details	Bilder
Hilfswerkzeug [15000155]	Montagekeil zum Ausrasten von Plastikteilen	
Schraubendreher Torx T20 mit Boh- rung [00340764]	100 mm, für Schrauben mit Si- cherheitsstift	
Drehmoment- Schlüssel [15000441]	Drehmoment-Schlüssel 20 - 100 Nm	
Schlitzschrauben- dreher [00340854]	Klinge 3,5 mm x 0,6 mm x 100 mm, Schutzisolation 1000 V Wechselstrom	
Schlitzschrauben- dreher [00340855]	Klinge 5,5 mm x 1,0 mm x 125 mm, Schutzisolation 1000 V Wechselstrom	
Spitzzange, gebo- gen [00341269]	Länge 200 mm	
Seitenschneider [00342182]	Länge: 200 mm	



Bezeichnung	Details	Bilder
Gabel-Ringschlüs- sel [00340811]	Schlüsselweite 10°mm, M6	
Combination wrench [00340814]	Schlüsselweite 13°mm, M8	
Gabel-Ringschlüs- sel [00340817]	Schlüsselweite 17 mm, M10	
Gabel-Ringschlüs- sel [15000459]	Schlüsselweite 16°mm, M10	

4.1 Arbeitsplatte tauschen

Spezielle Hilfsmittel:

-  Torx-Bit TX20 mit Bohrung, 6,3°mm (1/4") 152°mm, für Schrauben mit Sicherheitsstift [00341272] lang

Voraussetzung:

-  Das Gerät ist spannungsfrei.
-  Das Gerät ist von der Wasserversorgung getrennt.

4.1.1 Arbeitsplatte demontieren



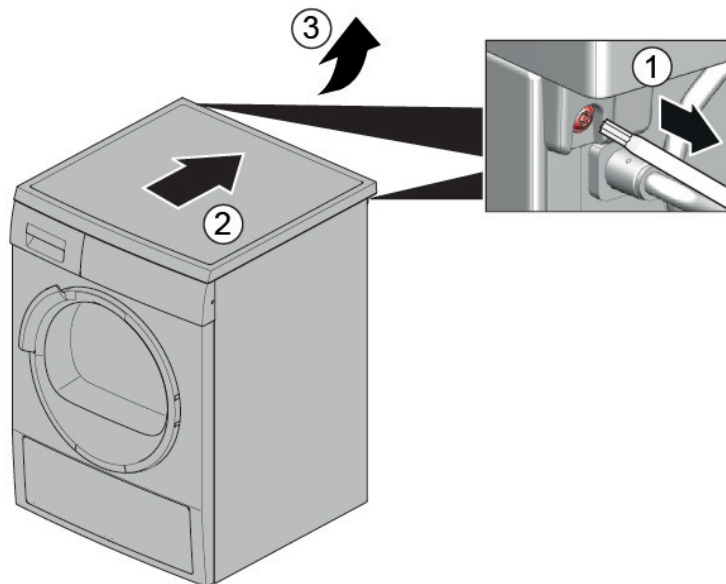

- ▶ 1. Schrauben entfernen (1).
- ▶ 2. Die Arbeitsplatte bis zur Geräterückseite schieben (2).
- ▶ 3. Die Arbeitsplatte nach oben (3) abnehmen.



4.1.2 Arbeitsplatte montieren

- ▶ Der Einbau erfolgt in umgekehrter Reihenfolge.

4.2 Austauschen der Bedienblende

	<p style="text-align: center;">⚠ VORSICHT</p> <p>Scharfe Gehäusekanten! Schnittverletzungen</p> <ul style="list-style-type: none"> ▶ Schutzhandschuhe tragen.
	<p style="text-align: center;">⚠ WARNUNG</p> <p>Wegrutschen des gekippten Gerätes! Knochenbrüche / Quetschungen</p> <ul style="list-style-type: none"> ▶ Gerät gegen Wegrutschen sichern.
	<p style="text-align: center;">⚠ VORSICHT</p> <p>Risiko herabfallender Teile durch gelöste Schrauben! Verletzungsgefahr durch herabfallende Teile.</p> <ul style="list-style-type: none"> ▶ Die Komponenten gegen Herunterfallen sichern.
	<p style="text-align: center;">⚠ ACHTUNG</p> <p>Risiko herabfallender Teile durch gelöste Schrauben! Gefahr der Beschädigung anderer Geräteteile bzw. von Beschädigungen im Haushalt des Kunden, z. B. des Bodens.</p> <ul style="list-style-type: none"> ▶ Die Komponenten gegen Herunterfallen sichern.

Voraussetzung:

- ✔ Das Gerät ist spannungsfrei.
- ✔ Das Gerät ist von der Wasserversorgung getrennt.
- ✔ [Die Arbeitsplatte ist entfernt worden. → Seite 205](#)
- ✔ [Die Waschmittelschublade ist entfernt worden. → Seite 207](#)

4.2.1 Ausbauen der Bedienblende

1. 1. Schrauben entfernen (1).
2. Die Rastelemente lösen (2, 3).

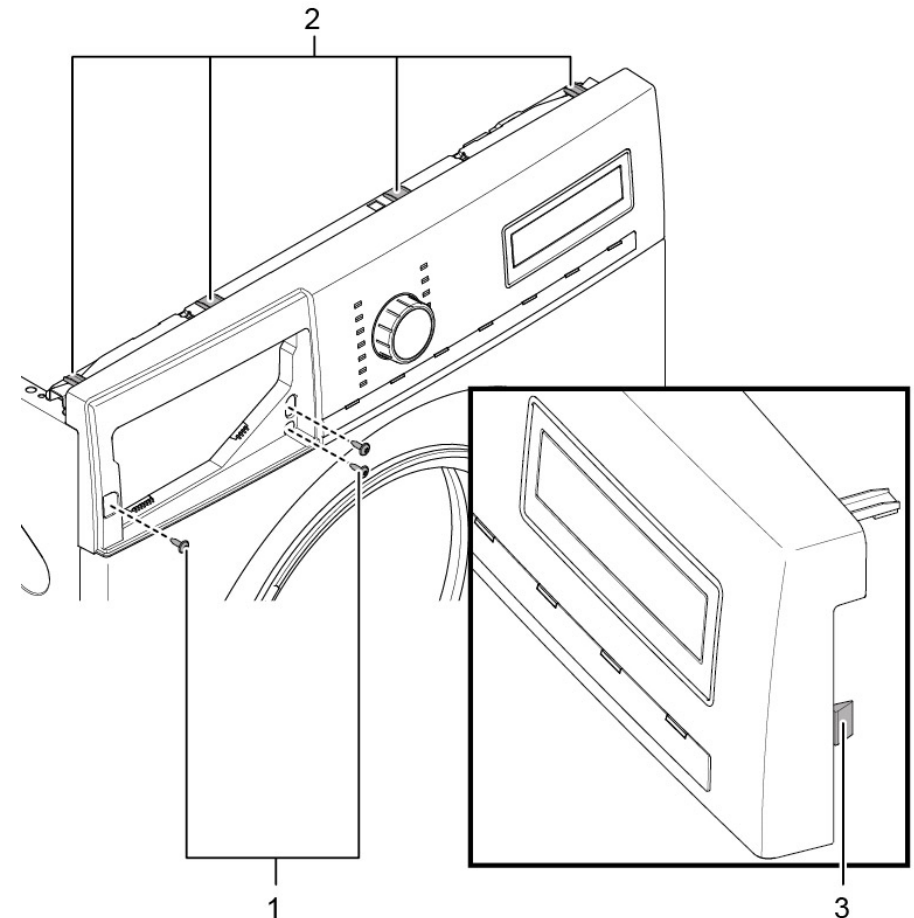

2. Den Steckkontakt der Steuereinheit lösen.
3. Die Bedienblende entfernen.

4.2.2 Einbauen der Bedienblende

- ▶ Der Einbau erfolgt in umgekehrter Reihenfolge.

4.3 Austauschen der Waschmittelschublade

Voraussetzung:

- ✓ Das Gerät ist spannungsfrei.
- ✓ Das Gerät ist von der Wasserversorgung getrennt.

4.3.1 Ausbauen der Waschmittelschublade

1. Die Waschmittelschublade herausziehen.
2. 1. Druck auf den Einsatz ausüben (1).
2. Die Waschmittelschublade entfernen (2).

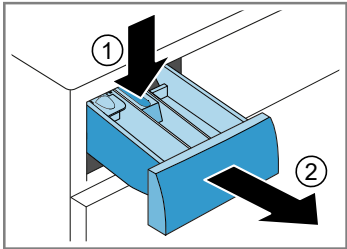

4.3.2 Einbauen der Waschmittelschublade

- ▶ Der Einbau erfolgt in umgekehrter Reihenfolge.

4.4 Austauschen des Griffs der Waschmittelschublade

Voraussetzung:

- ✓ Das Gerät ist spannungsfrei.
- ✓ Das Gerät ist von der Wasserversorgung getrennt.
- ✓ [Die Waschmittelschublade ist entfernt worden.](#) → [Seite 207](#)

4.4.1 Ausbauen des Griffs der Waschmittelschublade

1. Die Rastelemente lösen.

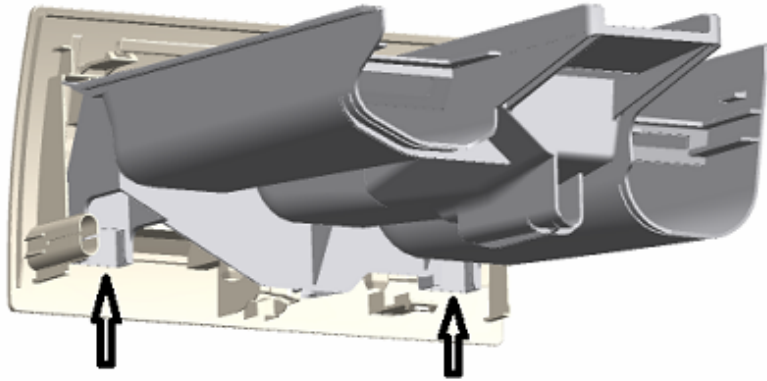

2. Den Griff der Waschmittelschublade entfernen.

4.4.2 Einbauen des Griffs der Waschmittelschublade

- ▶ Der Einbau erfolgt in umgekehrter Reihenfolge.

4.5 Tür austauschen

	⚠ VORSICHT Offener Scharnierbereich! Quetschen / Einklemmen der Finger ▶ Nicht in den Scharnierbereich greifen. ▶ Schutzhandschuhe tragen.
--	--

Voraussetzung:

- ✔ Das Gerät ist spannungsfrei.
- ✔ Das Gerät ist von der Wasserversorgung getrennt.
- ✔ Tür ist offen.

4.5.1 Ausbauen der Tür

1.

	ACHTUNG Risiko herabfallender Teile durch gelöste Schrauben! Gefahr der Beschädigung anderer Geräteteile bzw. von Beschädigungen im Haushalt des Kunden, z. B. des Bodens. ▶ Die Komponenten gegen Herunterfallen sichern.
---	---

	⚠ VORSICHT Risiko herabfallender Teile durch gelöste Schrauben! Verletzungsgefahr durch herabfallende Teile. ▶ Die Komponenten gegen Herunterfallen sichern.
---	---

Schrauben entfernen (1).

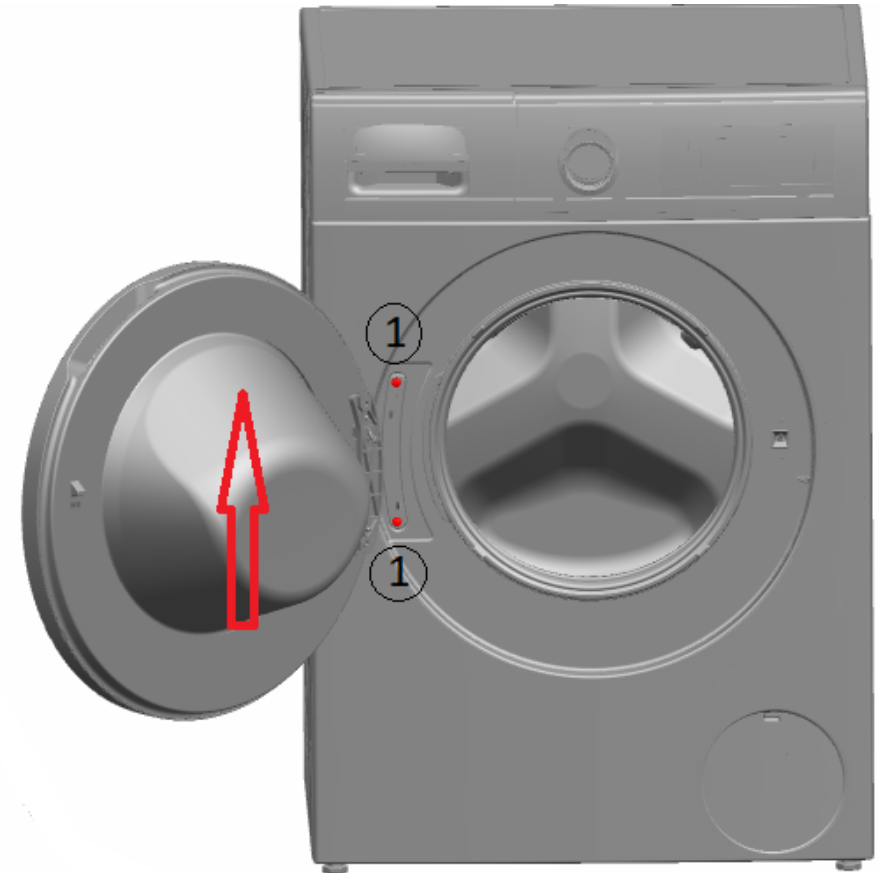

2. Die Tür nach oben entfernen.

4.5.2 Einbauen der Tür

- ▶ Der Einbau erfolgt in umgekehrter Reihenfolge.

4.6 Austauschen der Türkomponenten

	⚠ VORSICHT
	Offener Scharnierbereich! Quetschen / Einklemmen der Finger. <ul style="list-style-type: none">▶ Nicht in den Scharnierbereich greifen.▶ Schutzhandschuhe tragen.

Voraussetzung:

- ✓ Das Gerät ist spannungsfrei.
- ✓ Das Gerät ist von der Wasserversorgung getrennt.
- ✓ [Tür ist ausgebaut.](#) → [Seite 209](#)

4.6.1 Ausbauen der Türkomponenten

- ▶ Die Tür von außen nach innen demontieren.

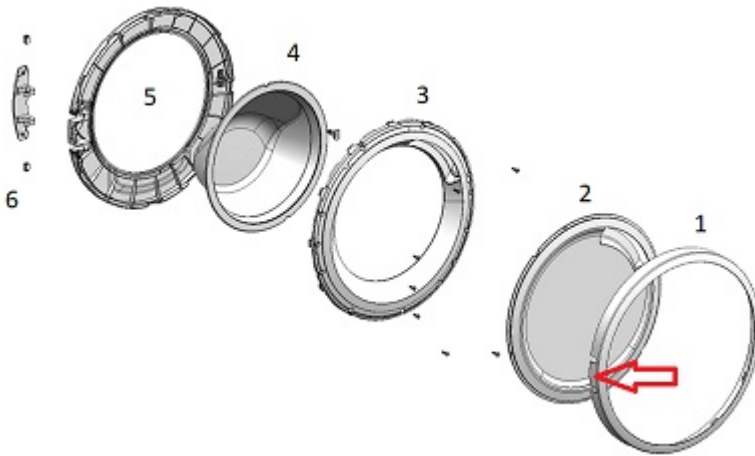



4.6.2 Einbauen der Türkomponenten

- ▶ Der Einbau erfolgt in umgekehrter Reihenfolge.

4.7 Austauschen der Türdichtung

	⚠ VORSICHT
Scharfe Gehäusekanten! Schnittverletzungen ▶ Schutzhandschuhe tragen.	

	⚠ VORSICHT
Risiko herabfallender Teile durch gelöste Schrauben! Verletzungsgefahr durch herabfallende Teile. ▶ Die Komponenten gegen Herunterfallen sichern.	

	ACHTUNG
Risiko herabfallender Teile durch gelöste Schrauben! Gefahr der Beschädigung anderer Geräteteile bzw. von Beschädigungen im Haushalt des Kunden, z. B. des Bodens. ▶ Die Komponenten gegen Herunterfallen sichern.	

Voraussetzung:

- ✔ Das Gerät ist spannungsfrei.
- ✔ Das Gerät ist von der Wasserversorgung getrennt.
- ✔ [Die Waschmittelschublade ist entfernt worden.→ Seite 207](#)
- ✔ [Tür ist ausgebaut.→ Seite 209](#)
- ✔ [Die Pumpenabdeckung ist entfernt worden.→ Seite 218](#)

4.7.1 Ausbauen der Türdichtung

	⚠ WARNUNG
Wegrutschen des gekippten Gerätes! Knochenbrüche / Quetschungen ▶ Gerät gegen Wegrutschen sichern.	

Das Gerät vorn anheben.

2. Die Schrauben an der Unterseite der Frontblende lösen (1).

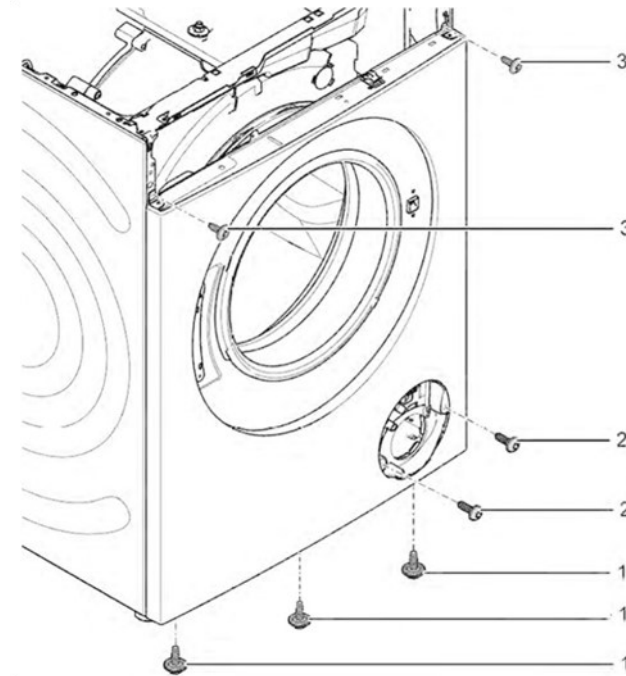

3. Das Gerät vorn wieder auf dem Boden abstellen.

Instandsetzen

4. Die Schrauben im Pumpenbereich entfernen (2).

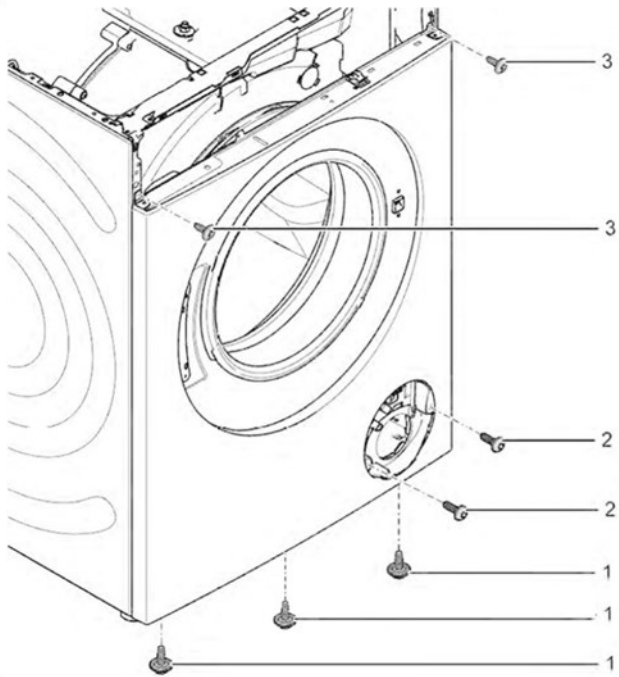

5. 1. Die Schrauben an der Geräterückseite lösen (1).
2. Die Arbeitsplatte abnehmen (2, 3).

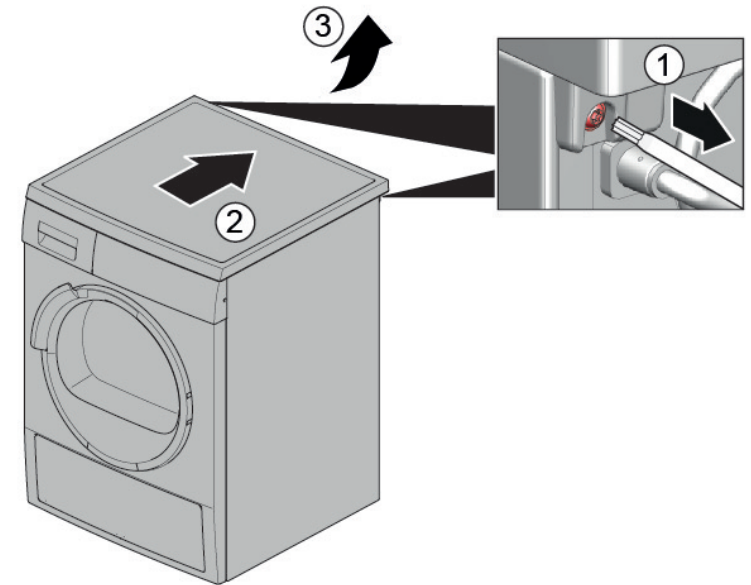

Instandsetzen

6. 1. Schrauben entfernen (1).
2. Die Rastelemente der Bedienblende lösen (2, 3).
3. Die Schrauben des Einspülschalengehäuses lösen.

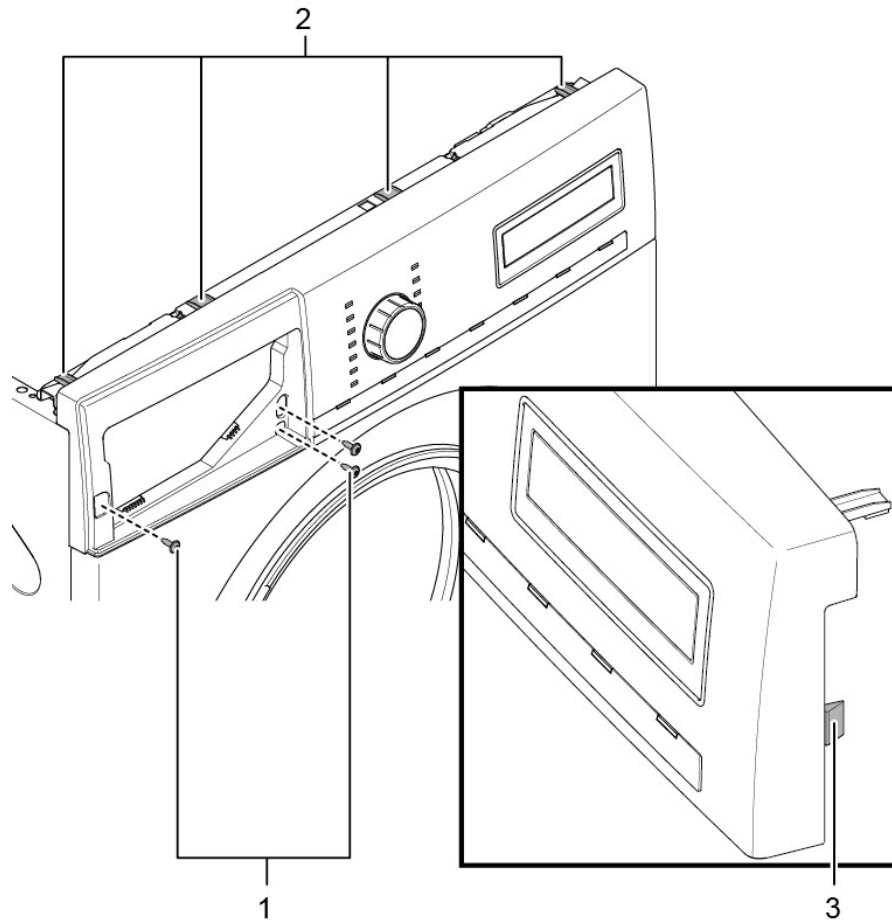

7. Die Bedienblende entfernen.

8. Die Trommelbeleuchtungshalterung an der Oberseite entfernen.

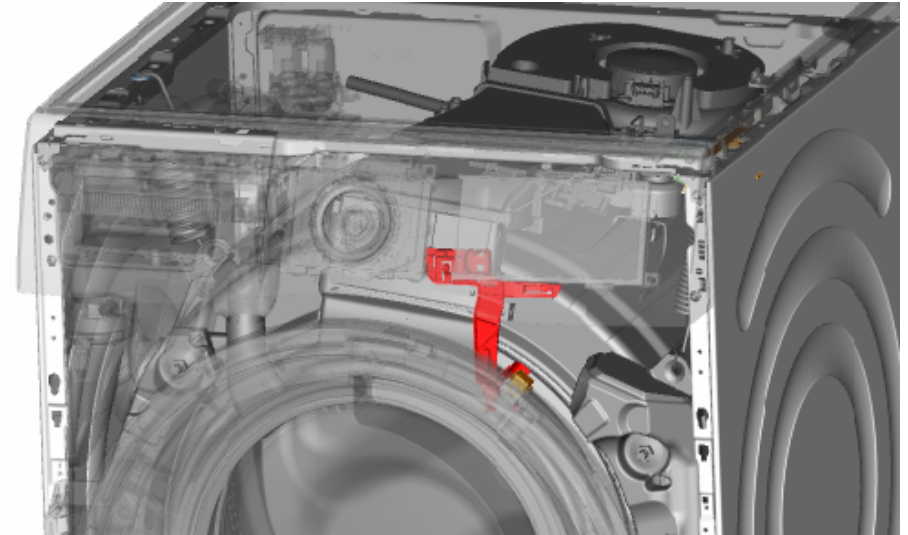

- 9.



ACHTUNG

Gefahr von Oberflächenschäden!

Bei Verwendung ungeeigneter Werkzeuge kann die Geräteoberfläche beschädigt werden.

- Für den Austausch des Spannrings dürfen ausschließlich Kunststoffwerkzeuge verwendet werden.

Den Spannring mit einem Kunststoffwerkzeug von der Dichtung entfernen.

10. Die Türdichtung von der Frontblende lösen.
11. Den Kabelsteckverbinder von der Türverriegelung lösen.

12. Die Schrauben an der Oberseite der Frontblende lösen (3).

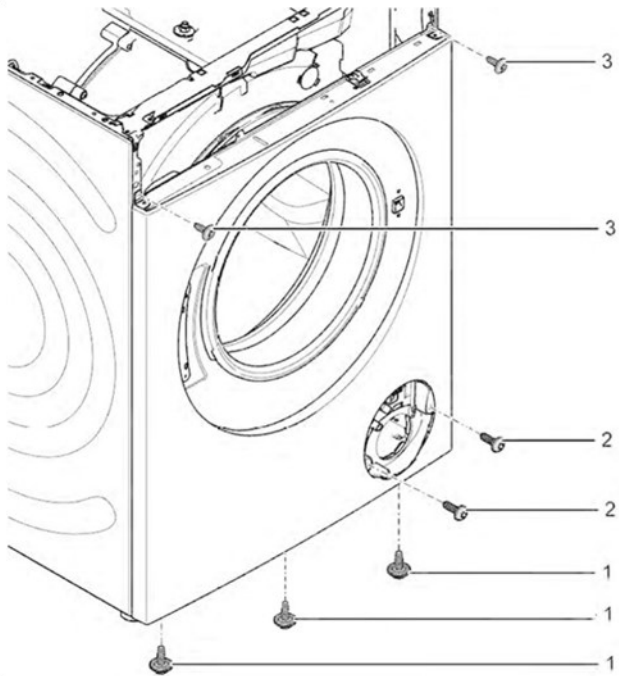

13. Die Frontblende entfernen.

14. Alle Schlauchanschlüsse lösen.

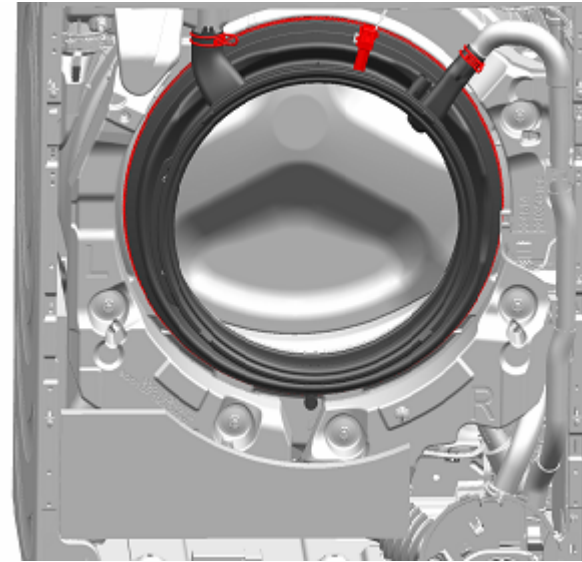

15. Die Türdichtung entfernen.

4.7.2 Einbauen der Türdichtung

	! WARNUNG
	Gefahr durch herabfallende Gegenstände aufgrund unsachgemäßer Montage! Verletzung oder Gerätebeschädigung. ▶ Spannring der Muffendichtung mit 3,4 Nm anziehen.

▶ Der Einbau erfolgt in umgekehrter Reihenfolge.

4.8 Austauschen der Türverriegelung

Als Hersteller sind wir nach der Verordnung (EU) 2019/2023 verpflichtet, Verbrauchern die Türsicherung, einschließlich Reparaturanleitung, als Ersatzteil zur Verfügung zu stellen. Wir möchten jedoch darauf hinweisen, dass nach dem Austausch einer Türsicherung eine elektrotechnische Sicherheitsprüfung durch eine Elektrofachkraft erforderlich ist, bevor das Gerät in Betrieb genommen wird. Diese Person muss nachweislich gemäß den länderspezifischen Gesetzen, Vorschriften und Normen qualifiziert sein.

	<p style="text-align: center;">GEFAHR</p> <p>Stromschlaggefahr durch spannungsführende Teile! Lebensgefahr durch Stromschlag bei unsachgemäßer Reparatur</p> <ul style="list-style-type: none"> ▶ Elektroteile sollten von einer Elektrofachkraft repariert werden. ▶ Nach der Reparatur muss eine Sicherheitsprüfung nach VDE 0701 oder länderspezifischen Vorschriften durchgeführt werden.
	<p style="text-align: center;">VORSICHT</p> <p>Scharfe Gehäusekanten! Schnittverletzungen</p> <ul style="list-style-type: none"> ▶ Schutzhandschuhe tragen.
	<p style="text-align: center;">WARNUNG</p> <p>Wegrutschen des gekippten Gerätes! Knochenbrüche / Quetschungen</p> <ul style="list-style-type: none"> ▶ Gerät gegen Wegrutschen sichern.
	<p style="text-align: center;">VORSICHT</p> <p>Risiko herabfallender Teile durch gelöste Schrauben! Verletzungsgefahr durch herabfallende Teile.</p> <ul style="list-style-type: none"> ▶ Die Komponenten gegen Herunterfallen sichern.
	<p style="text-align: center;">ACHTUNG</p> <p>Risiko herabfallender Teile durch gelöste Schrauben! Gefahr der Beschädigung anderer Geräteteile bzw. von Beschädigungen im Haushalt des Kunden, z. B. des Bodens.</p> <ul style="list-style-type: none"> ▶ Die Komponenten gegen Herunterfallen sichern.

Voraussetzung:

- ✓ Das Gerät ist spannungsfrei.

- ✓ Das Gerät ist von der Wasserversorgung getrennt.
- ✓ Das Gerät ist frei zugänglich.
- ✓ [Die Arbeitsplatte ist entfernt worden.→ Seite 205](#)
- ✓ Bedienblende ist abgebaut.
- ✓ [Tür ist ausgebaut.→ Seite 209](#)
- ✓ Der Spannung ist entfernt worden.
- ✓ Das Frontpanel ist entfernt worden.
- ✓ Türdichtung ist demontiert.

4.8.1 Türverriegelung demontieren

1. Den Stecker der Türverriegelung abziehen.
2. Die Türverriegelung lösen.



3. Die Türverriegelung entfernen.





4.8.2 Türverriegelung montieren

Die Türverriegelung muss sich in der richtigen Position befinden, um die ordnungsgemäße Notfall-Türöffnungsfunktion des Geräts sicherzustellen.



- ▶ Der Einbau erfolgt in umgekehrter Reihenfolge.

4.9 Austauschen der Trommelbeleuchtung

	VORSICHT Scharfe Gehäusekanten! Schnittverletzungen ▶ Schutzhandschuhe tragen.
	WARNUNG Wegrutschen des gekippten Gerätes! Knochenbrüche / Quetschungen ▶ Gerät gegen Wegrutschen sichern.
	VORSICHT Risiko herabfallender Teile durch gelöste Schrauben! Verletzungsgefahr durch herabfallende Teile. ▶ Die Komponenten gegen Herunterfallen sichern.
	ACHTUNG Risiko herabfallender Teile durch gelöste Schrauben! Gefahr der Beschädigung anderer Geräteteile bzw. von Beschädigungen im Haushalt des Kunden, z. B. des Bodens. ▶ Die Komponenten gegen Herunterfallen sichern.

Voraussetzung:

- ✔ Das Gerät ist spannungsfrei.
- ✔ Das Gerät ist von der Wasserversorgung getrennt.
- ✔ Das Gerät ist frei zugänglich.
- ✔ [Die Arbeitsplatte ist entfernt worden.→ Seite 205](#)
- ✔ [Die Waschmittelschublade ist entfernt worden.→ Seite 207](#)
- ✔ Bedienblende ist abgebaut.

4.9.1 Ausbauen der Trommelbeleuchtung

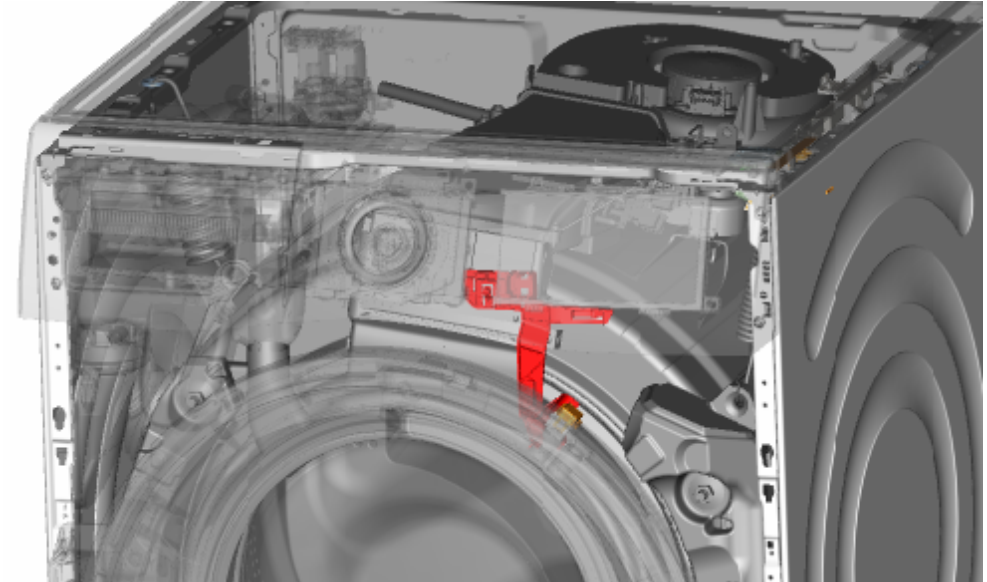

1. Die Trommelbeleuchtungshalterung aus dem Gerät ziehen.
2. Die elektrischen Anschlüsse trennen.
3. Die Trommelbeleuchtung aus der Trommelbeleuchtungshalterung entfernen.

4.9.2 Einbauen der Trommelbeleuchtung

- ▶ Der Einbau erfolgt in umgekehrter Reihenfolge.

4.10 Austauschen der Pumpenabdeckung

Voraussetzung:

- ✓ Das Gerät ist spannungsfrei.
- ✓ Das Gerät ist von der Wasserversorgung getrennt.

4.10.1 Ausbauen der Pumpenabdeckung

1. Die Pumpenabdeckung öffnen.

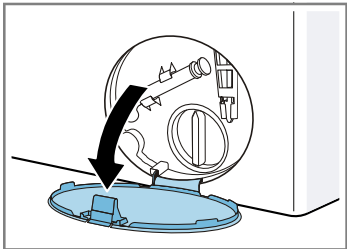

2. Die Pumpenabdeckung entfernen.

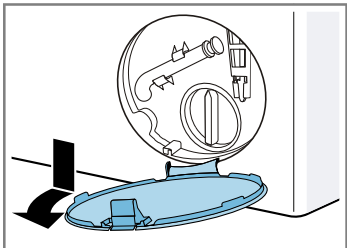

4.10.2 Einbauen der Pumpenabdeckung

- ▶ Der Einbau erfolgt in umgekehrter Reihenfolge.

4.11 Austauschen der Frontblende

	⚠ VORSICHT Scharfe Gehäusekanten! Schnittverletzungen ▶ Schutzhandschuhe tragen.
--	---

Voraussetzung:

- ✓ Das Gerät ist spannungsfrei.
- ✓ Das Gerät ist von der Wasserversorgung getrennt.
- ✓ [Die Waschmittelschublade ist entfernt worden. → Seite 207](#)
- ✓ [Tür ist ausgebaut. → Seite 209](#)
- ✓ Türdichtung ist demontiert.
- ✓ [Die Pumpenabdeckung ist entfernt worden. → Seite 218](#)

4.11.1 Ausbauen der Frontblende

1. 	⚠ WARNUNG Wegrutschen des gekippten Gerätes! Knochenbrüche / Quetschungen ▶ Gerät gegen Wegrutschen sichern.
--	---

Das Gerät vorn anheben.

2. Die Schrauben an der Unterseite entfernen (1).

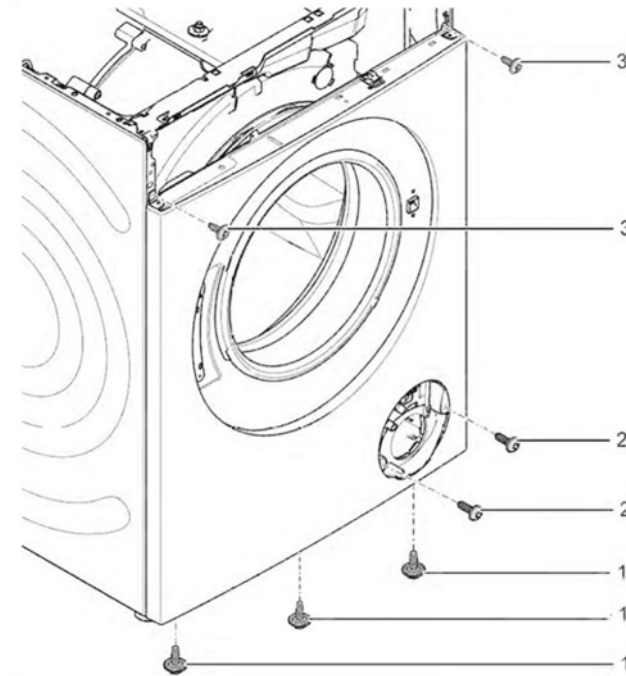

3. Das Gerät vorn wieder auf dem Boden abstellen.

Instandsetzen

4. 1. Schrauben entfernen (1).
2. Die Arbeitsplatte bis zur Geräterückseite schieben (2).
3. Die Arbeitsplatte nach oben (3) abnehmen.

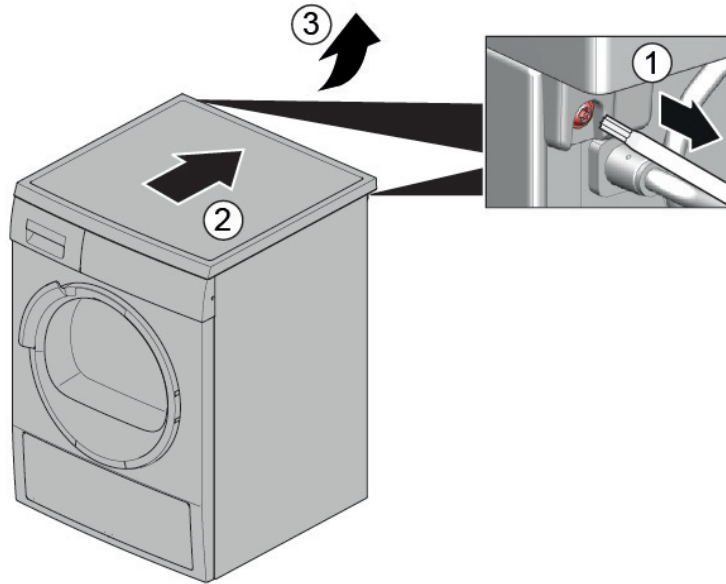

5. 1. Schrauben entfernen (1).
2. Die Rastelemente lösen (2, 3).

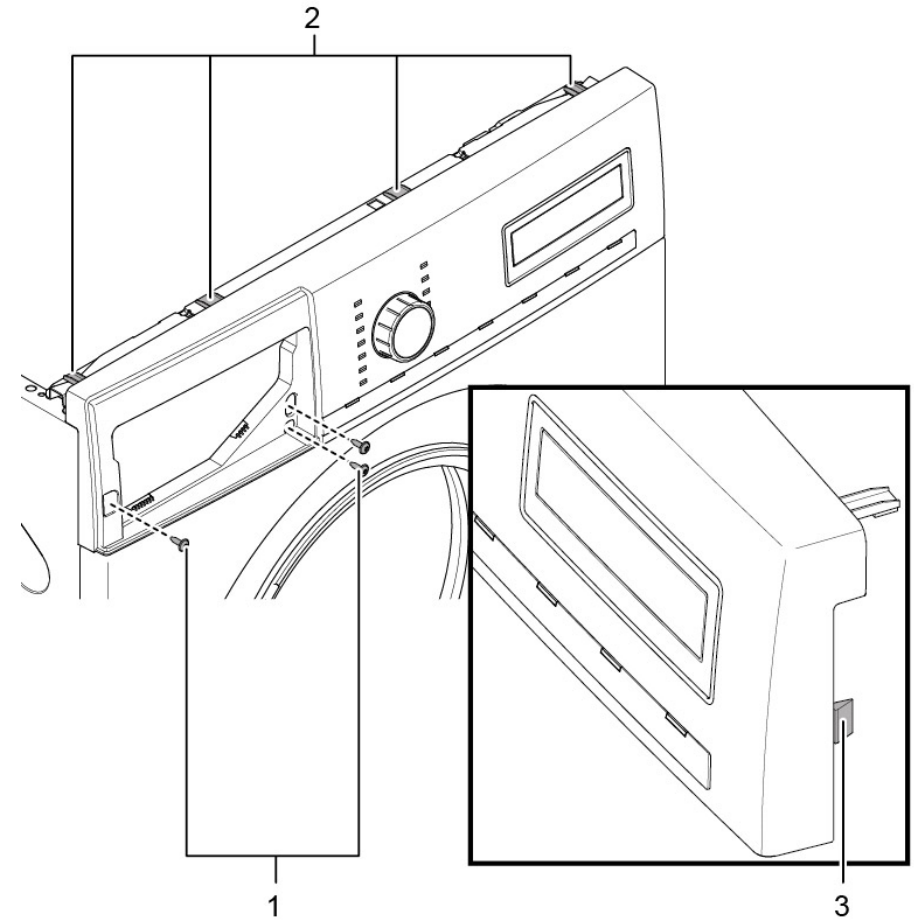

6. Die Bedienblende entfernen.

7.



⚠ VORSICHT

Risiko herabfallender Teile durch gelöste Schrauben!
Verletzungsgefahr durch herabfallende Teile.
► Die Komponenten gegen Herunterfallen sichern.



ACHTUNG

Risiko herabfallender Teile durch gelöste Schrauben!
Gefahr der Beschädigung anderer Geräteteile bzw. von Beschädigungen im Haushalt des Kunden, z. B. des Bodens.
▶ Die Komponenten gegen Herunterfallen sichern.

Die Schrauben an der Vorderseite von unten beginnend entfernen (2, 3).

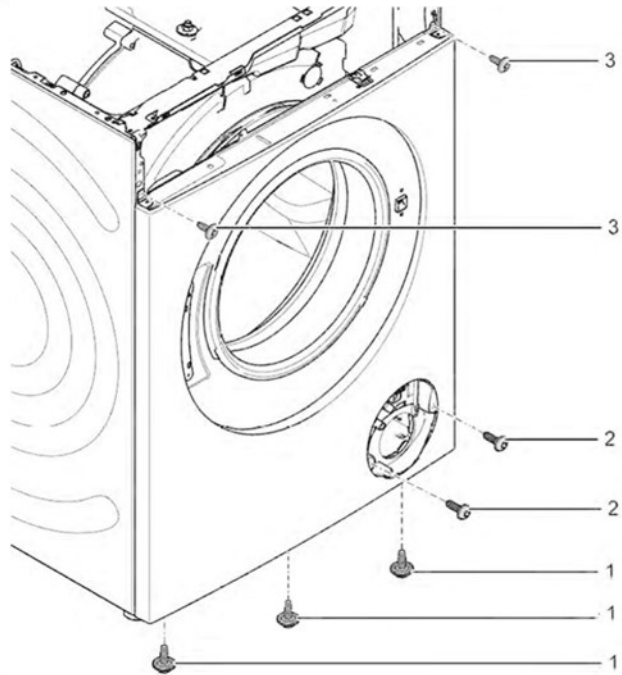





8. Die Frontblende entfernen.

4.11.2 Einbauen der Frontblende

▶ Der Einbau erfolgt in umgekehrter Reihenfolge.

Υποδείξεις επισκευής - Πλυντήριο ρούχων

 Σχετικά με αυτό το έγγραφο	223
1.1 Σημαντικές πληροφορίες.....	223
1.1.1 Σκοπός.....	223
1.2 Επεξήγηση συμβόλων.....	223
1.2.1 Επίπεδα κινδύνου.....	223
1.2.2 Σύμβολα κινδύνου.....	223
1.2.3 Δομή των προειδοποιήσεων.....	224
1.2.4 Γενικά σύμβολα.....	224
 Ασφάλεια	225
2.1 Γενικές οδηγίες ασφαλείας.....	225
2.1.1 Όλες οι οικιακές συσκευές.....	225
 Εργαλεία και βοηθήματα	226
 Επισκευή	227
4.1 Αντικατάσταση καπακιού εργασίας.....	227
4.1.1 Αφαίρεση καπακιού εργασίας.....	227
4.1.2 Τοποθέτηση καπακιού εργασίας.....	227
4.2 Αντικατάσταση μετώπης.....	228
4.2.1 Αφαίρεση μετώπης.....	228
4.2.2 Τοποθέτηση μετώπης.....	228
4.3 Αντικατάσταση συρταριού απορρυπαντικού.....	229
4.3.1 Αφαίρεση συρταριού απορρυπαντικού.....	229
4.3.2 Τοποθέτηση συρταριού απορρυπαντικού.....	229
4.4 Αντικατάσταση λαβής συρταριού απορρυπαντικού.....	230
4.4.1 Αφαίρεση λαβής συρταριού απορρυπαντικού.....	230
4.4.2 Τοποθέτηση λαβής συρταριού απορρυπαντικού.....	230
4.5 Αντικατάσταση πόρτας.....	231
4.5.1 Αφαίρεση πόρτας.....	231
4.5.2 Τοποθέτηση πόρτας.....	231
4.6 Αντικατάσταση εξαρτημάτων πόρτας.....	232
4.6.1 Αφαίρεση εξαρτημάτων πόρτας.....	232
4.6.2 Τοποθέτηση εξαρτημάτων πόρτας.....	232
4.7 Αντικατάσταση στεγανοποιητικού πόρτας.....	233
4.7.1 Αφαίρεση στεγανοποιητικού πόρτας.....	233
4.7.2 Τοποθέτηση στεγανοποιητικού πόρτας.....	236

4.8 Αντικατάσταση ασφάλειας πόρτας.....	237
4.8.1 Αφαίρεση ασφάλειας πόρτας.....	237
4.8.2 Τοποθέτηση ασφάλειας πόρτας.....	238
4.9 Αντικατάσταση φωτισμού τυμπάνου.....	239
4.9.1 Αφαίρεση φωτισμού τυμπάνου.....	239
4.9.2 Τοποθέτηση φωτισμού τυμπάνου.....	239
4.10 Αντικατάσταση καλύμματος αντλίας.....	240
4.10.1 Αφαίρεση καλύμματος αντλίας.....	240
4.10.2 Τοποθέτηση καλύμματος αντλίας.....	240
4.11 Αντικατάσταση μπροστινού πίνακα.....	241
4.11.1 Αφαίρεση μπροστινού πίνακα.....	241
4.11.2 Τοποθέτηση μπροστινής μετώπης.....	243

i Σχετικά με αυτό το έγγραφο

1.1 Σημαντικές πληροφορίες

1.1.1 Σκοπός

Αυτές οι συμβουλές επισκευών υποστηρίζουν τους καταναλωτές στην επισκευή των συσκευών από τους ίδιους, σύμφωνα με τον ισχύοντα κανονισμό οικολογικού σχεδιασμού (από τις 03/2021).

Περιέχουν πληροφορίες για την αντικατάσταση ορισμένων ανταλλακτικών, συμπεριλαμβανομένων προειδοποιήσεων και κινδύνων.

Σε περίπτωση ερωτήσεων, επικοινωνήστε με το τμήμα εξυπηρέτησης πελατών της εταιρείας μας. Φέρουμε ευθύνη για τις ζημιές εάν οι συμβουλές επισκευής έχουν ακολουθηθεί σωστά.

1.2 Επεξήγηση συμβόλων

1.2.1 Επίπεδα κινδύνου

Τα επίπεδα προειδοποίησης ασφάλειας αποτελούνται από ένα σύμβολο και μια λέξη. Η λέξη προειδοποίησης προσδιορίζει τη σοβαρότητα του κινδύνου.





Επίπεδο προειδοποίησης	Σημασία
 ΚΙΝΔΥΝΟΣ	Η μη τήρηση του προειδοποιητικού μηνύματος θα οδηγήσει σε θάνατο ή σε σοβαρούς τραυματισμούς.
 ΠΡΟΕΙΔΟΠΟΙΗΣΗ	Η μη τήρηση του προειδοποιητικού μηνύματος θα μπορούσε να οδηγήσει σε θάνατο ή σε σοβαρούς τραυματισμούς.
 ΠΡΟΣΟΧΗ	Η μη τήρηση του προειδοποιητικού μηνύματος θα μπορούσε να οδηγήσει σε μικρούς τραυματισμούς.
 ΠΡΟΣΟΧΗ!	Η μη τήρηση του προειδοποιητικού μηνύματος θα μπορούσε να οδηγήσει σε υλικές ζημιές της ιδιοκτησίας.

Πίνακας 1: Επίπεδα κινδύνου





1.2.2 Σύμβολα κινδύνου

Τα σύμβολα κινδύνου είναι συμβολικές αναπαραστάσεις που δίνουν μια ένδειξη για το είδος του κινδύνου.

Τα ακόλουθα σύμβολα κινδύνου χρησιμοποιούνται στο παρόν έγγραφο:

Σύμβολο κινδύνου	Σημασία
	Γενικό προειδοποιητικό μήνυμα
	Κίνδυνος από ηλεκτρική τάση
	Κίνδυνος έκρηξης
	Κίνδυνος κοψίματος

i Σχετικά με αυτό το έγγραφο

Σύμβολο κινδύνου	Σημασία
	Κίνδυνος σύνθλιψης
	Κίνδυνος από καυτές επιφάνειες
	Κίνδυνος από ισχυρό μαγνητικό πεδίο
	Κίνδυνος από μη ιονίζουσα ακτινοβολία

Πίνακας 2: Σύμβολα κινδύνου

1.2.3 Δομή των προειδοποιήσεων

.Οι προειδοποιήσεις σε αυτό το έγγραφο έχουν μια τυποποιημένη εμφάνιση και μια τυποποιημένη δομή.









	⚠ ΚΙΝΔΥΝΟΣ
Είδος και πηγή κινδύνου!	
Πιθανές συνέπειες εάν αγνοήσετε τον κίνδυνο/την προειδοποίηση.	
▶ Μέτρα και απαγορεύσεις για την πρόληψη του κινδύνου.	

Το παρακάτω παράδειγμα δείχνει μια προειδοποίηση που προειδοποιεί κατά της ηλεκτροπληξίας λόγω ηλεκτροφόρων μερών. Αναφέρεται το μέτρο για την αποφυγή του κινδύνου.

	⚠ ΚΙΝΔΥΝΟΣ
Κίνδυνος ηλεκτροπληξίας λόγω ηλεκτροφόρων μερών!	
Θάνατος από ηλεκτροπληξία	
▶ Αποσυνδέετε τις συσκευές από την παροχή ηλεκτρικού ρεύματος τουλάχιστον 60 δευτερόλεπτα πριν ξεκινήσετε τις επισκευές.	

1.2.4 Γενικά σύμβολα

Τα ακόλουθα γενικά σύμβολα χρησιμοποιούνται στο παρόν έγγραφο:

Γεν. σύμβολο	Σημασία
	Ταυτοποίηση μιας ειδικής συμβουλής (κειμένου ή/και γραφικών)
	Ταυτοποίηση μιας ειδικής συμβουλής (μόνο κειμένου)
	Ταυτοποίηση συνδέσμου ή εκπαιδευτικού βίντεο
	Ταυτοποίηση απαραίτητων εργαλείων
	Ταυτοποίηση απαραίτητων προϋποθέσεων
	Ταυτοποίηση μιας συνθήκης (αν ..., κατόπιν ...)
	Ταυτοποίηση αποτελέσματος
	Ταυτοποίηση ενός πλήκτρου ή κουμπιού
	Ταυτοποίηση ενός κωδικού ανταλλακτικού
	Ταυτοποίηση εμφανιζόμενου κειμένου/παραθύρου (στην οθόνη της συσκευής)

Πίνακας 3: Γενικά σύμβολα

2.1 Γενικές οδηγίες ασφαλείας

2.1.1 Όλες οι οικιακές συσκευές

Κίνδυνος ηλεκτροπληξίας λόγω ηλεκτροφόρων μερών!

- Τα σφάλματα από επισκευές σε ηλεκτρικά εξαρτήματα μπορεί να προκαλέσουν ηλεκτροπληξία!
- Αποσυνδέστε τη συσκευή από την πρίζα για τουλάχιστον 60 δευτερόλεπτα πριν από την έναρξη των εργασιών.
- Μετά την επισκευή πραγματοποιήστε έλεγχο ασφαλείας σύμφωνα με το VDE 0701 ή κανονισμούς της συγκεκριμένης χώρας.

Κίνδυνος τραυματισμού από κοφτερές άκρες!

- Φοράτε προστατευτικά γάντια.

Κίνδυνος σύνθλιψης κατά την επισκευή, συντήρηση, αντιμετώπιση προβλημάτων και το σέρβις από βαριά και κινούμενα μέρη

- Φοράτε προστατευτικά υποδήματα.
- Ασφαλίστε τα βαριά μέρη από πτώση.
- Μην προσαρτάτε μέρη του πλαισίου στα κινούμενα μέρη.







Κίνδυνος για την ασφάλεια/τη λειτουργία της συσκευής!

- Χρησιμοποιείτε μόνο γνήσια ανταλλακτικά.

Κίνδυνος πρόκλησης βλάβης σε μέρη ευαίσθητα στον στατικό ηλεκτρισμό (ESDs)!

- Μην αγγίζετε τις μονάδες, συμπεριλαμβανομένων των συνδέσεων και των αγωγών των πλακετών.

Εργαλεία και βοηθήματα

Όνομασία	Λεπτομέριες	Εικόνες
Βοηθητικό εργαλείο [15000155]	Εργαλείο λυσίματος πλαστικών τμημάτων	
Κατσαβίδι Torx T20 με τρύπα [00340764]	100 mm, για βίδες με κοπίλια	
Ροπόκλειδο [15000441]	Ροπόκλειδο 20 - 100 Nm	
Πλακέ κατσαβίδι [00340854]	Λεπίδα 3,5 mm x 0,6 mm x 100 mm, Προστατευτική μόνωση 1000 V AC	
Πλακέ κατσαβίδι [00340855]	Λεπίδα 5,5 mm x 1,0 mm x 125 mm, Προστατευτική μόνωση 1000 V AC	
Μυτοσίμπιδο, γωνιαστό [00341269]	Μήκος 200 mm	
Κοφτάκι [00342182]	Μήκος: 200 mm	



Όνομασία	Λεπτομέριες	Εικόνες
Συνδυαστικό κλειδί (Γερμανοπολύγωνο) [00340811]	Νούμερο κλειδιού (Γερμανοπολύγωνο) 10 ^ο mm, M6	
Combination wrench [00340814]	Νούμερο κλειδιού (Γερμανοπολύγωνο) 13 ^ο mm, M8	
Συνδυαστικό κλειδί (Γερμανοπολύγωνο) [00340817]	Νούμερο κλειδιού (Γερμανοπολύγωνο) 17 mm, M10	
Συνδυαστικό κλειδί (Γερμανοπολύγωνο) [15000459]	Νούμερο κλειδιού (Γερμανοπολύγωνο) 16 ^ο mm, M10	

4.1 Αντικατάσταση καπακιού εργασίας

Ειδικά βοηθητικά μέσα:

-  Μύτη Torx TX20 με τρύπα, μα- 6,3°mm (1/4") 152°mm, για βίδες με κοπίλια ασφαλείας [00341272]

Προϋπόθεση:

-  Η συσκευή είναι αποσυνδεδεμένη από την παροχή τροφοδοσίας.
-  Η συσκευή είναι αποσυνδεδεμένη από την παροχή νερού.

4.1.1 Αφαίρεση καπακιού εργασίας



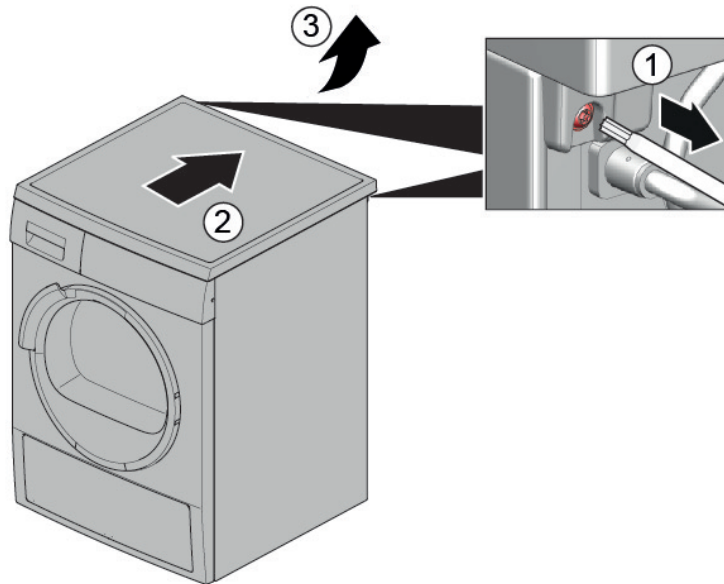

- ▶ 1. Αφαιρέστε τις βίδες (1).
- ▶ 2. Σπρώξτε το καπάκι εργασίας στην πίσω πλευρά της συσκευής (2).
- ▶ 3. Μετακινήστε το καπάκι εργασίας προς τα επάνω (3) για να το αφαιρέσετε.



4.1.2 Τοποθέτηση καπακιού εργασίας

- ▶ Εγκαταστήστε με την αντίθετη σειρά.

4.2 Αντικατάσταση μετώπης

	<p>⚠ ΠΡΟΣΟΧΗ</p> <p>Αιχμηρά άκρα περιβλήματος! Τραυματισμοί από κοπή</p> <ul style="list-style-type: none"> ▶ Φοράτε προστατευτικά γάντια.
	<p>⚠ ΠΡΟΕΙΔΟΠΟΙΗΣΗ</p> <p>Ολίσθηση κεκλιμένων συσκευών! Κατάγματα οστών/τραυματισμοί σύνθλιψης</p> <ul style="list-style-type: none"> ▶ Ασφαλίστε τις συσκευές από ολίσθηση.
	<p>⚠ ΠΡΟΣΟΧΗ</p> <p>Κίνδυνοι από πτώση μερών εξαιτίας χαλαρών βιδών! Τραυματισμός εξαιτίας πτώσης τμημάτων.</p> <ul style="list-style-type: none"> ▶ Ασφαλίστε τα εξαρτήματα από πτώση.
	<p>ΠΡΟΣΟΧΗ!</p> <p>Κίνδυνων από πτώση εξαρτημάτων εξαιτίας χαλαρών βιδών! Ζημιά σε άλλα μέρη της συσκευής ή στην οικία του πελάτη, π.χ. δάπεδο.</p> <ul style="list-style-type: none"> ▶ Ασφαλίστε τα εξαρτήματα από πτώση.

Προϋπόθεση:

- ✔ Η συσκευή είναι αποσυνδεμένη από την παροχή τροφοδοσίας.
- ✔ Η συσκευή είναι αποσυνδεμένη από την παροχή νερού.
- ✔ [Έχει αφαιρεθεί το καπάκι εργασίας.→227](#)
- ✔ [Έχει αφαιρεθεί το συρτάρι απορρυπαντικού.→229](#)

4.2.1 Αφαίρεση μετώπης

1. 1. Αφαιρέστε τις βίδες (1).
2. 2. Απασφαλίστε τα στοιχεία συγκράτησης (2, 3).

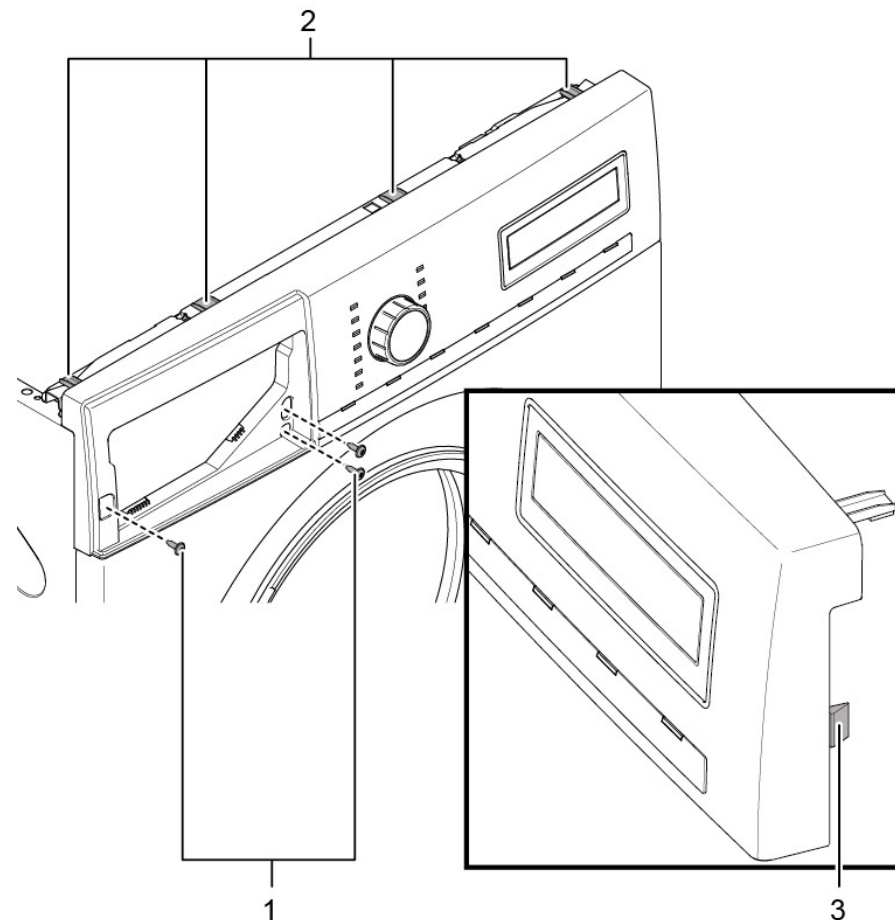

2. 2. Απασφαλίστε την επαφή βύσματος της πλακέτας ελέγχου.
3. 3. Αφαιρέστε τη μετώπη.

4.2.2 Τοποθέτηση μετώπης

- ▶ Εγκαταστήστε με την αντίθετη σειρά.

4.3 Αντικατάσταση συρταριού απορρυπαντικού

Προϋπόθεση:

- ✓ Η συσκευή είναι αποσυνδεδεμένη από την παροχή τροφοδοσίας.
- ✓ Η συσκευή είναι αποσυνδεδεμένη από την παροχή νερού.

4.3.1 Αφαίρεση συρταριού απορρυπαντικού

1. Τραβήξτε έξω το συρτάρι απορρυπαντικού.
2. 1. Πιέστε κάτω το ένθετο (1).
2. Αφαιρέστε το συρτάρι απορρυπαντικού (2).

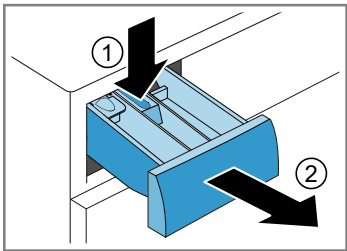

4.3.2 Τοποθέτηση συρταριού απορρυπαντικού

- ▶ Εγκαταστήστε με την αντίθετη σειρά.

4.4 Αντικατάσταση λαβής συρταριού απορρυπαντικού

Προϋπόθεση:

- ✔ Η συσκευή είναι αποσυνδεδεμένη από την παροχή τροφοδοσίας.
- ✔ Η συσκευή είναι αποσυνδεδεμένη από την παροχή νερού.
- ✔ [Έχει αφαιρεθεί το συρτάρι απορρυπαντικού.→229](#)

4.4.1 Αφαίρεση λαβής συρταριού απορρυπαντικού

1. Απασφαλίστε τα στοιχεία συγκράτησης.

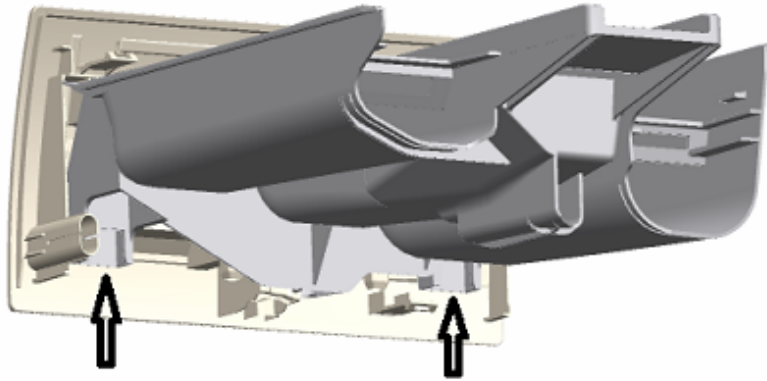

2. Αφαιρέστε τη λαβή συρταριού απορρυπαντικού.

4.4.2 Τοποθέτηση λαβής συρταριού απορρυπαντικού

- ▶ Εγκαταστήστε με την αντίθετη σειρά.

4.5 Αντικατάσταση πόρτας



ΠΡΟΣΟΧΗ

Ανοίξτε την περιοχή με τους μεντεσέδες!

Σύνθλιψη/παγίδευση δακτύλων

- ▶ Μην αγγίζετε την περιοχή με τους μεντεσέδες.
- ▶ Φοράτε προστατευτικά γάντια.

Προϋπόθεση:

- ✔ Η συσκευή είναι αποσυνδεδεμένη από την παροχή τροφοδοσίας.
- ✔ Η συσκευή είναι αποσυνδεδεμένη από την παροχή νερού.
- ✔ Η πόρτα είναι ανοιχτή.

4.5.1 Αφαίρεση πόρτας

1.



ΠΡΟΣΟΧΗ!

Κίνδυνων από πτώση εξαρτημάτων εξαιτίας χαλαρών βιδών!

Ζημιά σε άλλα μέρη της συσκευής ή στην οικία του πελάτη, π.χ. δάπεδο.

- ▶ Ασφαλίστε τα εξαρτήματα από πτώση.



ΠΡΟΣΟΧΗ

Κίνδυνοι από πτώση μερών εξαιτίας χαλαρών βιδών!

Τραυματισμός εξαιτίας πτώσης τμημάτων.

- ▶ Ασφαλίστε τα εξαρτήματα από πτώση.

Αφαιρέστε τις βίδες (1).

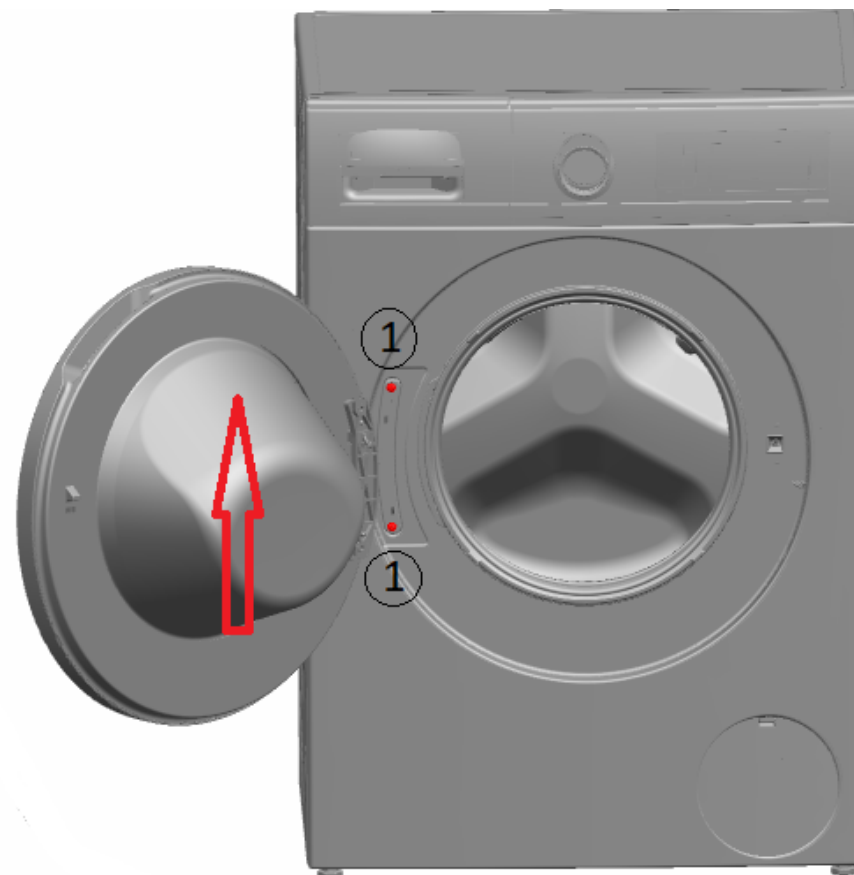

2. Αφαιρέστε την πόρτα προς τα επάνω.

4.5.2 Τοποθέτηση πόρτας

- ▶ Εγκαταστήστε με την αντίθετη σειρά.

4.6 Αντικατάσταση εξαρτημάτων πόρτας



⚠️ ΠΡΟΣΟΧΗ

Ανοίξτε την περιοχή με τους μεντεσέδες!

Σύνθλιψη/παγίδευση δακτύλων

- ▶ Μην αγγίζετε την περιοχή με τους μεντεσέδες.
- ▶ Φοράτε προστατευτικά γάντια.

Προϋπόθεση:

- ✔ Η συσκευή είναι αποσυνδεδεμένη από την παροχή τροφοδοσίας.
- ✔ Η συσκευή είναι αποσυνδεδεμένη από την παροχή νερού.
- ✔ [Η πόρτα έχει αφαιρεθεί. → 231](#)

4.6.1 Αφαίρεση εξαρτημάτων πόρτας

- ▶ Αποσυναρμολογήστε την πόρτα από έξω προς τα μέσα.

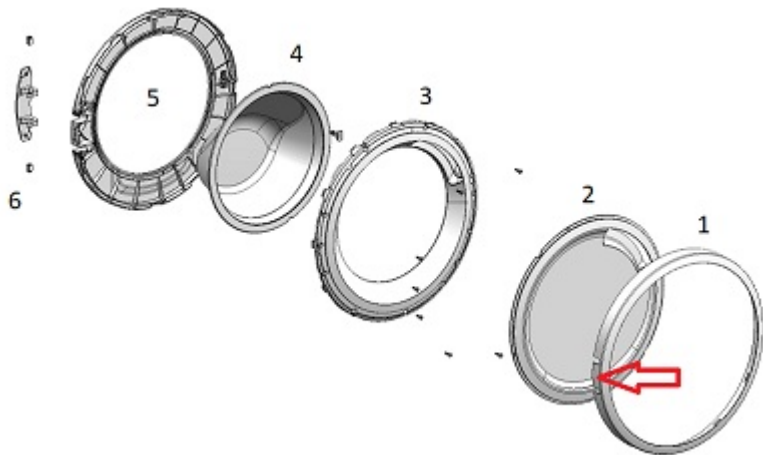



4.6.2 Τοποθέτηση εξαρτημάτων πόρτας

- ▶ Εγκαταστήστε με την αντίθετη σειρά.

4.7 Αντικατάσταση στεγανοποιητικού πόρτας

	⚠ ΠΡΟΣΟΧΗ
	<p>Αιχμηρά άκρα περιβλήματος! Τραυματισμοί από κοπή</p> <ul style="list-style-type: none"> ▶ Φοράτε προστατευτικά γάντια.

	⚠ ΠΡΟΣΟΧΗ
	<p>Κίνδυνοι από πτώση μερών εξαιτίας χαλαρών βιδών! Τραυματισμός εξαιτίας πτώσης τμημάτων.</p> <ul style="list-style-type: none"> ▶ Ασφαλίστε τα εξαρτήματα από πτώση.

	ΠΡΟΣΟΧΗ!
	<p>Κίνδυνων από πτώση εξαρτημάτων εξαιτίας χαλαρών βιδών! Ζημιά σε άλλα μέρη της συσκευής ή στην οικία του πελάτη, π.χ. δάπεδο.</p> <ul style="list-style-type: none"> ▶ Ασφαλίστε τα εξαρτήματα από πτώση.

Προϋπόθεση:

- ✔ Η συσκευή είναι αποσυνδεδεμένη από την παροχή τροφοδοσίας.
- ✔ Η συσκευή είναι αποσυνδεδεμένη από την παροχή νερού.
- ✔ [Έχει αφαιρεθεί το συρτάρι απορρυπαντικού.→229](#)
- ✔ [Η πόρτα έχει αφαιρεθεί.→231](#)
- ✔ [Το κάλυμμα αντλίας έχει αφαιρεθεί.→240](#)

4.7.1 Αφαίρεση στεγανοποιητικού πόρτας

1. 	⚠ ΠΡΟΕΙΔΟΠΟΙΗΣΗ
	<p>Ολίσθηση κεκλιμένων συσκευών! Κατάγματα οστών/τραυματισμοί σύνθλιψης</p> <ul style="list-style-type: none"> ▶ Ασφαλίστε τις συσκευές από ολίσθηση.

Ανασηκώστε τη συσκευή μπροστά.

2. Λύστε τις βίδες στο κάτω μέρος του μπροστινού πίνακα (1).

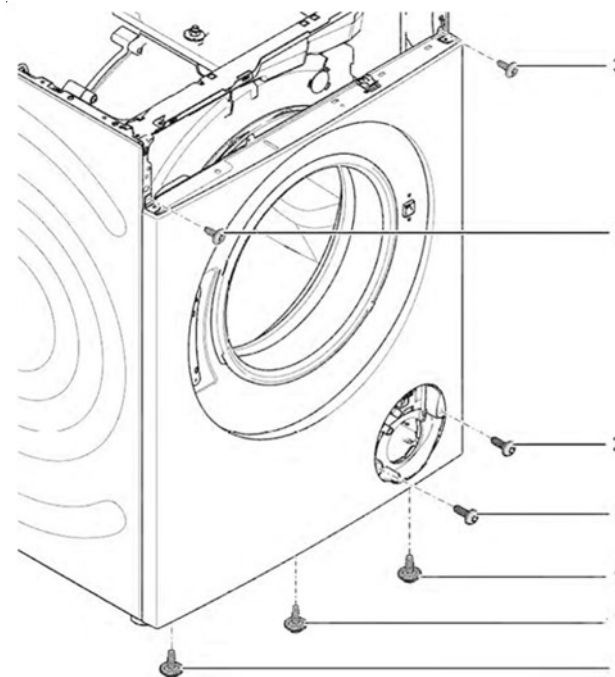

3. Κατεβάστε τη συσκευή.

4. Αφαιρέστε τις βίδες στην περιοχή της αντλίας (2).

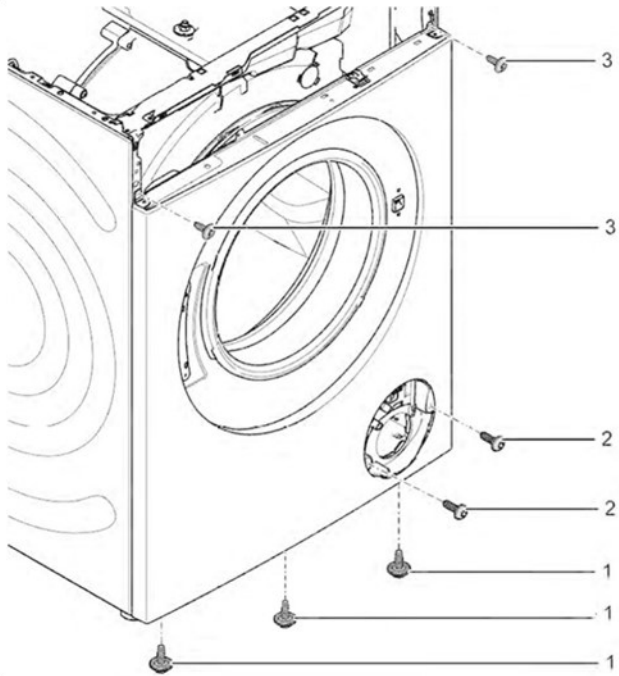

5. 1. Λύστε τις βίδες στο πίσω μέρος της συσκευής (1).
2. Αφαιρέστε το καπάκι εργασίας (2, 3).

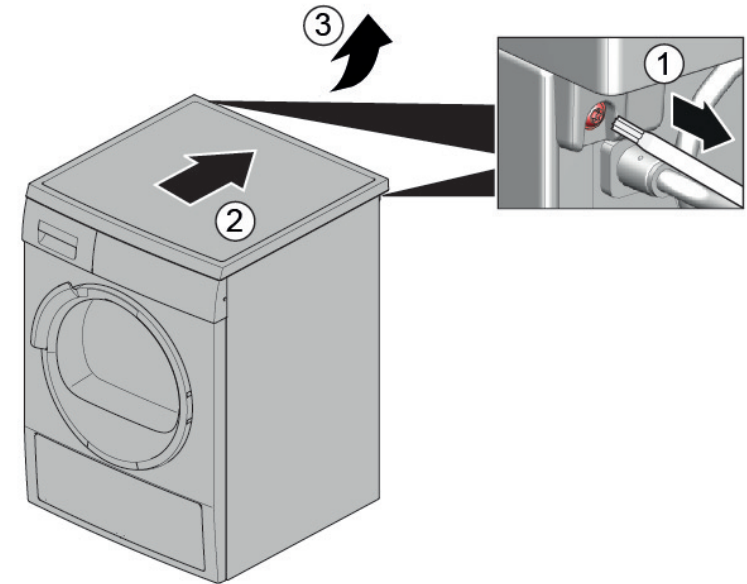

1. Αφαιρέστε τις βίδες (1).
2. Απασφαλίστε τα εξαρτήματα συγκράτησης στη μετώπη (2, 3).
3. Λύστε τις βίδες στο περίβλημα του διανομέα.

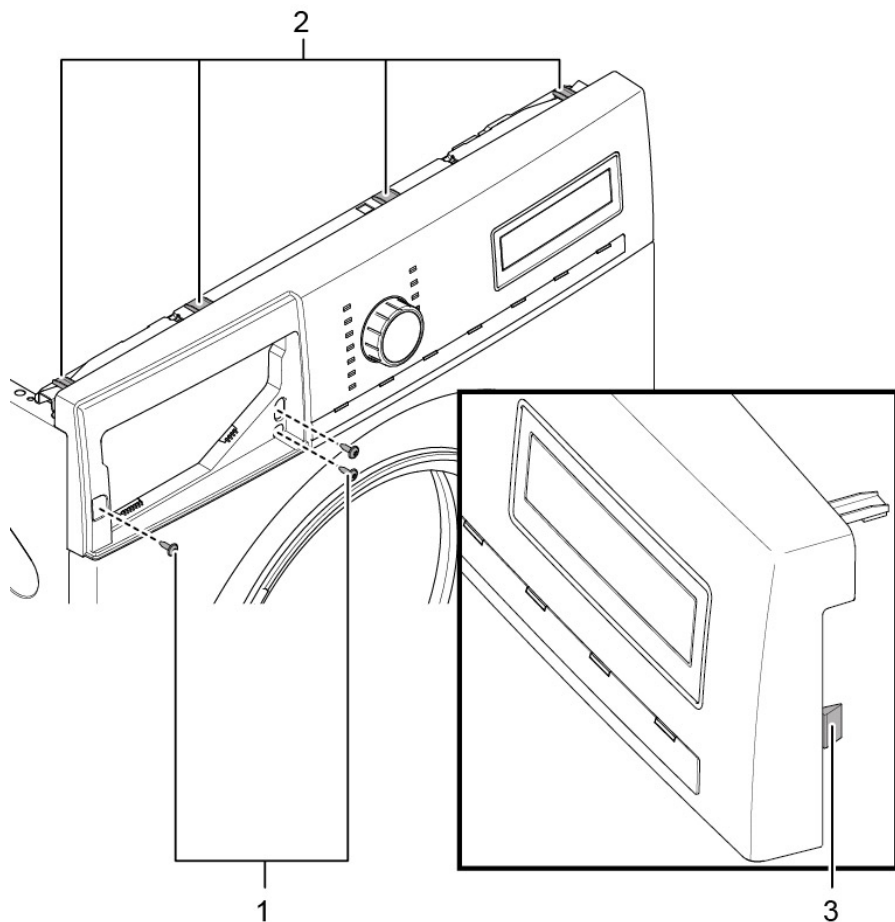

7. Αφαιρέστε τη μετώπη.

8. Αφαιρέστε τη βάση του φωτός τυμπάνου στο επάνω μέρος.

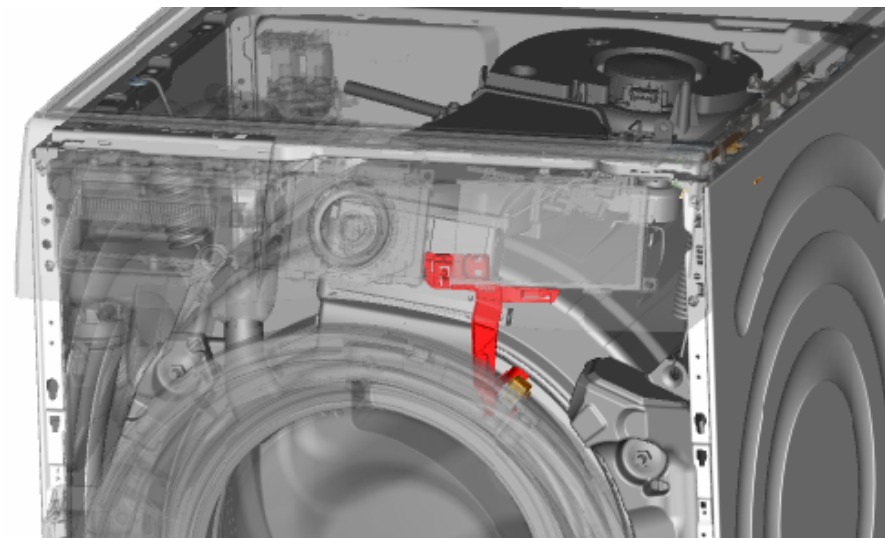

- 9.



ΠΡΟΣΟΧΗ!

Κίνδυνος κατεστραμμένης επιφάνειας!

Η επιφάνεια της συσκευής μπορεί να γρατσουνιστεί από ακατάλληλα εργαλεία.

- ▶ Χρησιμοποιείτε μόνο πλαστικά εργαλεία για την αντικατάσταση του δακτυλίου τάνυσης.

Αφαιρέστε τον δακτύλιο τάνυσης από την τσιμούχα με πλαστικό εργαλείο.

10. Βγάλτε το στεγανοποιητικό πόρτας από τον μπροστινό πίνακα.
11. Βγάλτε τον συνδετήρα καλωδίου από την ασφάλεια πόρτας.

12. Λύστε τις βίδες στο επάνω μέρος του μπροστινού πίνακα (3).

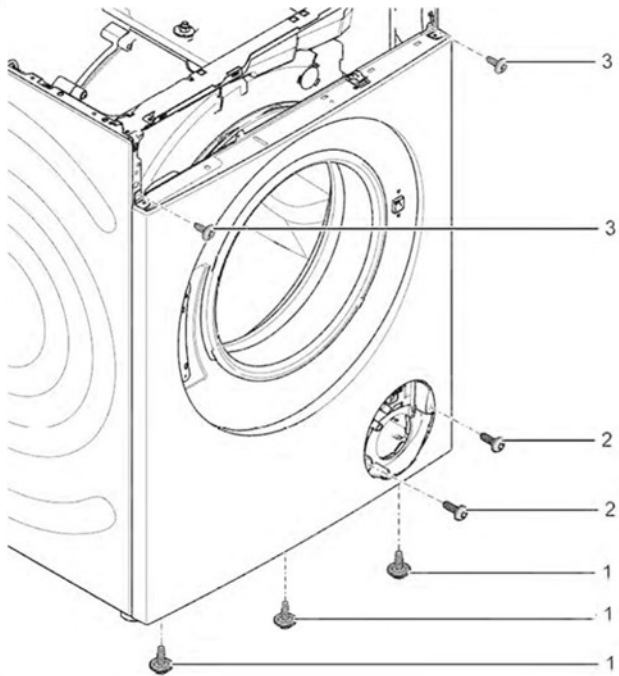

13. Αφαιρέστε το μπροστινό πλαίσιο.

14. Λύστε όλες τις συνδέσεις εύκαμπτου σωλήνα.

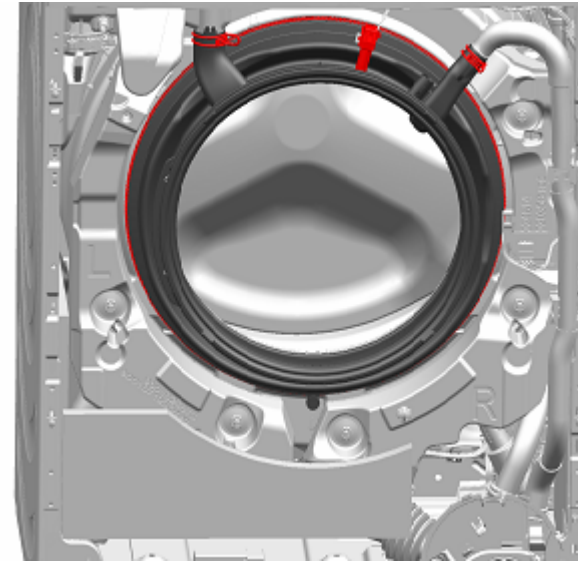

15. Αφαιρέστε το στεγανοποιητικό της πόρτας.

4.7.2 Τοποθέτηση στεγανοποιητικού πόρτας

	ΠΡΟΕΙΔΟΠΟΙΗΣΗ
	Κίνδυνος από πτώση μερών εξαιτίας εσφαλμένης εγκατάστασης! Τραυματισμός ή βλάβη στη συσκευή. ▶ Σφίξτε τον δακτύλιο τάνσης για το λάστιχο της πόρτας με 3,4 Nm.

▶ Εγκαταστήστε με την αντίθετη σειρά.

4.8 Αντικατάσταση ασφάλειας πόρτας

Ως κατασκευαστής, υποχρεούμαστε να παρέχουμε στους πελάτες την ανταλλακτική ασφάλεια πόρτας, συμπεριλαμβανομένων των οδηγιών επισκευής σύμφωνα με τον Κανονισμό (ΕΕ) 2019/2023. Ωστόσο, θα θέλαμε να επισημάνουμε ότι μετά την αντικατάσταση της ασφάλειας πόρτας, απαιτείται ένας έλεγχος ηλεκτροτεχνικής ασφάλειας από εκπαιδευμένο ηλεκτρολόγο πριν τεθεί σε λειτουργία η συσκευή. Αυτό το άτομο πρέπει να είναι αποδεδειγμένα εκπαιδευμένο σύμφωνα με τους νόμους, τους κανονισμούς και τα πρότυπα της συγκεκριμένης χώρας.

	⚠ ΚΙΝΔΥΝΟΣ
	<p>Κίνδυνος ηλεκτροπληξίας λόγω ηλεκτροφόρων μερών! Κίνδυνος για τη ζωή από ηλεκτροπληξία σε περίπτωση ακατάλληλης επισκευής</p> <ul style="list-style-type: none"> ▶ Τα ηλεκτρικά μέρη πρέπει να επισκευάζονται από εκπαιδευμένους ηλεκτρολόγους. ▶ Μετά την επισκευή πραγματοποιήστε έλεγχο ασφάλειας σύμφωνα με το VDE 0701 ή κανονισμούς της συγκεκριμένης χώρας.

	⚠ ΠΡΟΣΟΧΗ
	<p>Αιχμηρά άκρα περιβλήματος! Τραυματισμοί από κοπή</p> <ul style="list-style-type: none"> ▶ Φοράτε προστατευτικά γάντια.

	⚠ ΠΡΟΕΙΔΟΠΟΙΗΣΗ
	<p>Ολίσθηση κεκλιμένων συσκευών! Κατάγματα οστών/τραυματισμοί σύνθλιψης</p> <ul style="list-style-type: none"> ▶ Ασφαλίστε τις συσκευές από ολίσθηση.

	⚠ ΠΡΟΣΟΧΗ
	<p>Κίνδυνοι από πτώση μερών εξαιτίας χαλαρών βιδών! Τραυματισμός εξαιτίας πτώσης τμημάτων.</p> <ul style="list-style-type: none"> ▶ Ασφαλίστε τα εξαρτήματα από πτώση.

	ΠΡΟΣΟΧΗ!
	<p>Κίνδυνων από πτώση εξαρτημάτων εξαιτίας χαλαρών βιδών! Ζημιά σε άλλα μέρη της συσκευής ή στην οικία του πελάτη, π.χ. δάπεδο.</p> <ul style="list-style-type: none"> ▶ Ασφαλίστε τα εξαρτήματα από πτώση.

Προϋπόθεση:

- ✓ Η συσκευή είναι αποσυνδεδεμένη από την παροχή τροφοδοσίας.
- ✓ Η συσκευή είναι αποσυνδεδεμένη από την παροχή νερού.
- ✓ Η πρόσβαση στις συσκευές είναι ελεύθερη.
- ✓ [Έχει αφαιρεθεί το καπάκι εργασίας.→227](#)
- ✓ Έχει αφαιρεθεί η μετώπη.
- ✓ [Η πόρτα έχει αφαιρεθεί.→231](#)
- ✓ Έχει αφαιρεθεί ο δακτύλιος τάνυσης.
- ✓ Έχει αφαιρεθεί ο μπροστινός πίνακας.
- ✓ Έχει αφαιρεθεί το στεγανοποιητικό πόρτας.

4.8.1 Αφαίρεση ασφάλειας πόρτας

1. Αποσυνδέστε το βύσμα ασφάλειας πόρτας.
2. Απασφαλίστε την ασφάλεια πόρτας.



3. Αφαιρέστε την ασφάλεια πόρτας.

4.8.2 Τοποθέτηση ασφάλειας πόρτας

Η ασφάλεια πόρτας πρέπει να βρίσκεται στη σωστή θέση για να είναι βέβαιη η λειτουργία ανοίγματος της πόρτας έκτακτης ανάγκης της συσκευής.





- ▶ Εγκαταστήστε με την αντίθετη σειρά.

4.9 Αντικατάσταση φωτισμού τυμπάνου

	⚠ ΠΡΟΣΟΧΗ Αιχμηρά άκρα περιβλήματος! Τραυματισμοί από κοπή ▶ Φοράτε προστατευτικά γάντια.
--	--

	⚠ ΠΡΟΕΙΔΟΠΟΙΗΣΗ Ολίσθηση κεκλιμένων συσκευών! Κατάγματα οστών/τραυματισμοί σύνθλιψης ▶ Ασφαλίστε τις συσκευές από ολίσθηση.
--	--

	⚠ ΠΡΟΣΟΧΗ Κίνδυνοι από πτώση μερών εξαιτίας χαλαρών βιδών! Τραυματισμός εξαιτίας πτώσης τμημάτων. ▶ Ασφαλίστε τα εξαρτήματα από πτώση.
--	---

	ΠΡΟΣΟΧΗ! Κίνδυνων από πτώση εξαρτημάτων εξαιτίας χαλαρών βιδών! Ζημιά σε άλλα μέρη της συσκευής ή στην οικία του πελάτη, π.χ. δάπεδο. ▶ Ασφαλίστε τα εξαρτήματα από πτώση.
--	---

Προϋπόθεση:

- ✔ Η συσκευή είναι αποσυνδεμένη από την παροχή τροφοδοσίας.
- ✔ Η συσκευή είναι αποσυνδεμένη από την παροχή νερού.
- ✔ Η πρόσβαση στις συσκευές είναι ελεύθερη.
- ✔ [Έχει αφαιρεθεί το καπάκι εργασίας.→227](#)
- ✔ [Έχει αφαιρεθεί το συρτάρι απορρυπαντικού.→229](#)
- ✔ Έχει αφαιρεθεί η μετώπη.

4.9.1 Αφαίρεση φωτισμού τυμπάνου

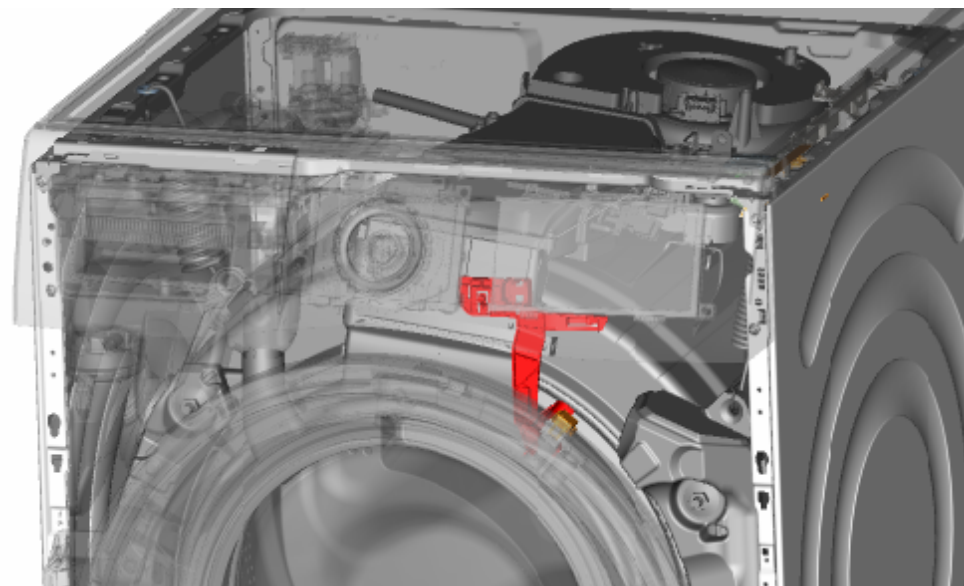

1. Αφαιρέστε τη βάση του φωτισμού τυμπάνου από τη συσκευή.
2. Αποσυνδέστε τις ηλεκτρικές συνδέσεις.
3. Αφαιρέστε τον φωτισμό τυμπάνου από τη βάση του φωτισμού τυμπάνου.

4.9.2 Τοποθέτηση φωτισμού τυμπάνου

- ▶ Εγκαταστήστε με την αντίθετη σειρά.

4.10 Αντικατάσταση καλύμματος αντλίας

Προϋπόθεση:

- ✓ Η συσκευή είναι αποσυνδεδεμένη από την παροχή τροφοδοσίας.
- ✓ Η συσκευή είναι αποσυνδεδεμένη από την παροχή νερού.

4.10.1 Αφαίρεση καλύμματος αντλίας

1. Ανοίξτε το κάλυμμα της αντλίας.

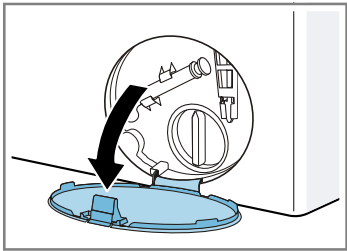

2. Αφαιρέστε το κάλυμμα της αντλίας.

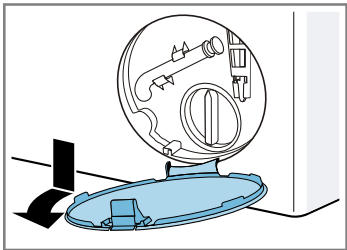

4.10.2 Τοποθέτηση καλύμματος αντλίας

- ▶ Εγκαταστήστε με την αντίθετη σειρά.

4.11 Αντικατάσταση μπροστινού πίνακα



⚠️ ΠΡΟΣΟΧΗ

Αιχμηρά άκρα περιβλήματος!

Τραυματισμοί από κοπή

- ▶ Φοράτε προστατευτικά γάντια.

Προϋπόθεση:

- ✔ Η συσκευή είναι αποσυνδεδεμένη από την παροχή τροφοδοσίας.
- ✔ Η συσκευή είναι αποσυνδεδεμένη από την παροχή νερού.
- ✔ [Έχει αφαιρεθεί το συρτάρι απορρυπαντικού. → 229](#)
- ✔ [Η πόρτα έχει αφαιρεθεί. → 231](#)
- ✔ Έχει αφαιρεθεί το στεγανοποιητικό πόρτας.
- ✔ [Το κάλυμμα αντλίας έχει αφαιρεθεί. → 240](#)

4.11.1 Αφαίρεση μπροστινού πίνακα

1.



⚠️ ΠΡΟΕΙΔΟΠΟΙΗΣΗ

Ολίσθηση κεκλιμένων συσκευών!

Κατάγματα οστών/τραυματισμοί σύνθλιψης

- ▶ Ασφαλίστε τις συσκευές από ολίσθηση.

Ανασηκώστε τη συσκευή μπροστά.

2. Αφαιρέστε τις βίδες στο κάτω μέρος (1).

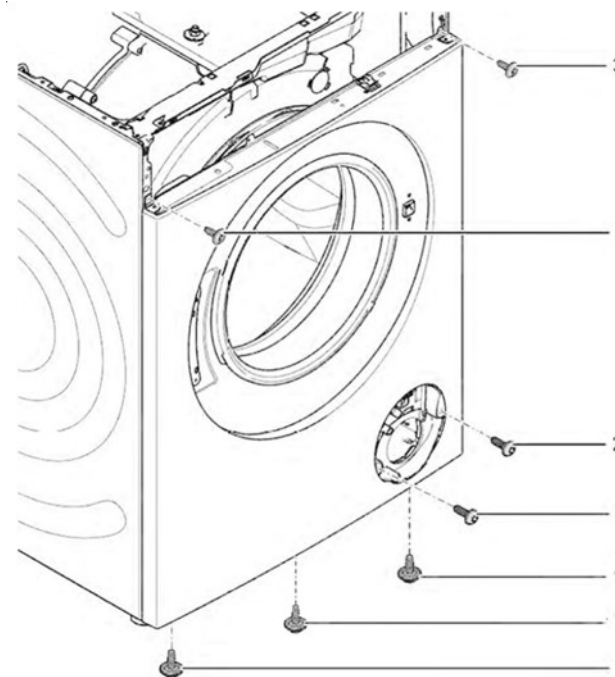

3. Κατεβάστε τη συσκευή.

ΕΠΙΣΚΕΥΗ

4. 1. Αφαιρέστε τις βίδες (1).
2. Σπρώξτε το καπάκι εργασίας στην πίσω πλευρά της συσκευής (2).
3. Μετακινήστε τον πάγκο προς τα επάνω (3) για να τον αφαιρέσετε.

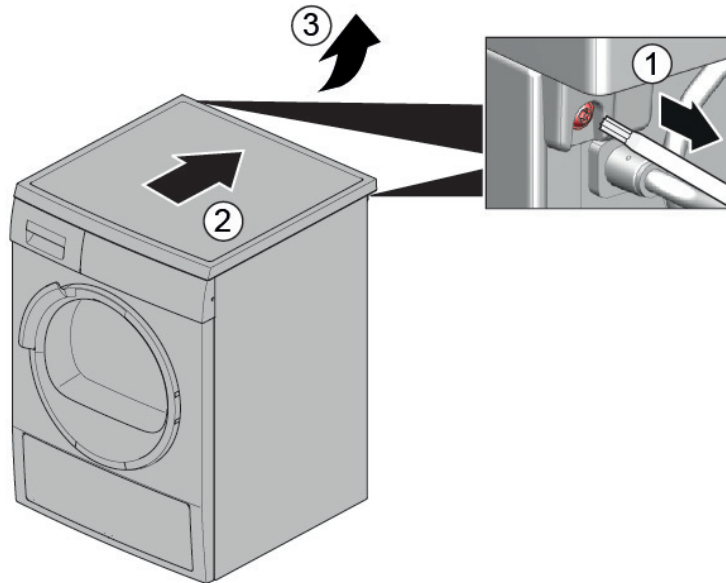

5. 1. Αφαιρέστε τις βίδες (1).
2. Απασφαλίστε τα στοιχεία συγκράτησης (2, 3).

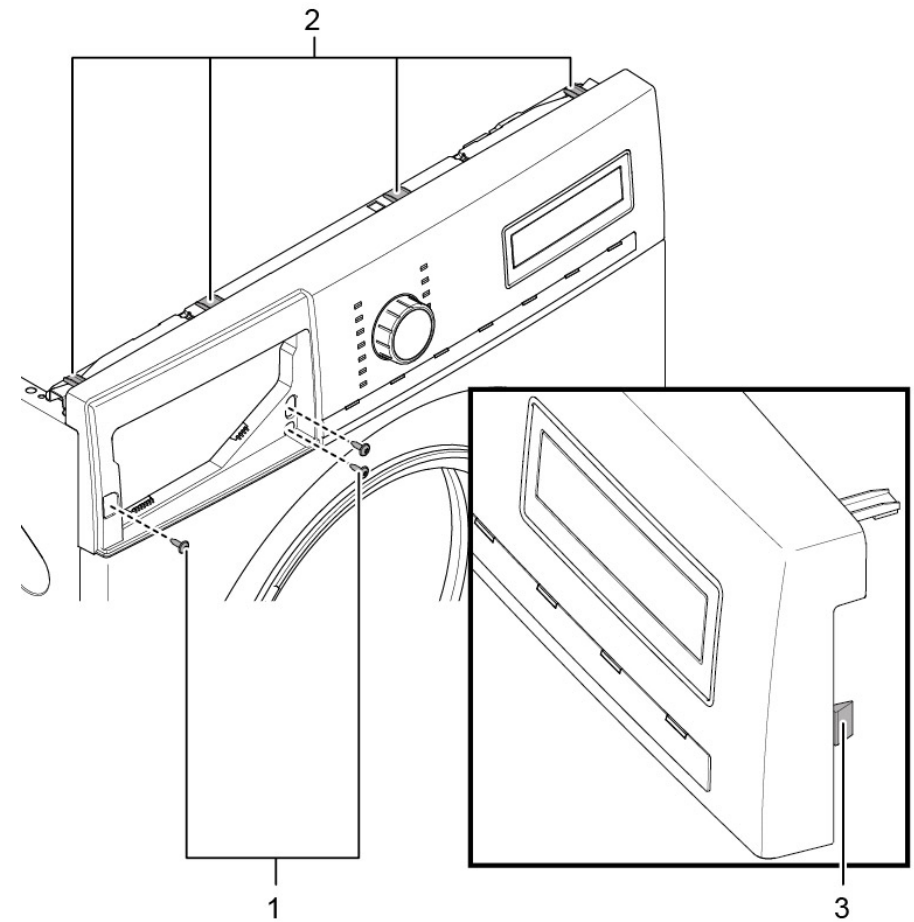

6. Αφαιρέστε τη μετώπη.

7.



⚠ ΠΡΟΣΟΧΗ

Κίνδυνοι από πτώση μερών εξαιτίας χαλαρών βιδών!
Τραυματισμός εξαιτίας πτώσης τμημάτων.
▶ Ασφαλίστε τα εξαρτήματα από πτώση.



ΠΡΟΣΟΧΗ!

Κίνδυνων από πτώση εξαρτημάτων εξαιτίας χαλαρών βιδών!
Ζημιά σε άλλα μέρη της συσκευής ή στην οικία του πελάτη, π.χ. δάπεδο.

- ▶ Ασφαλίστε τα εξαρτήματα από πτώση.

Αφαιρέστε τις βίδες στο μπροστινό μέρος από κάτω προς τα επάνω (2, 3).

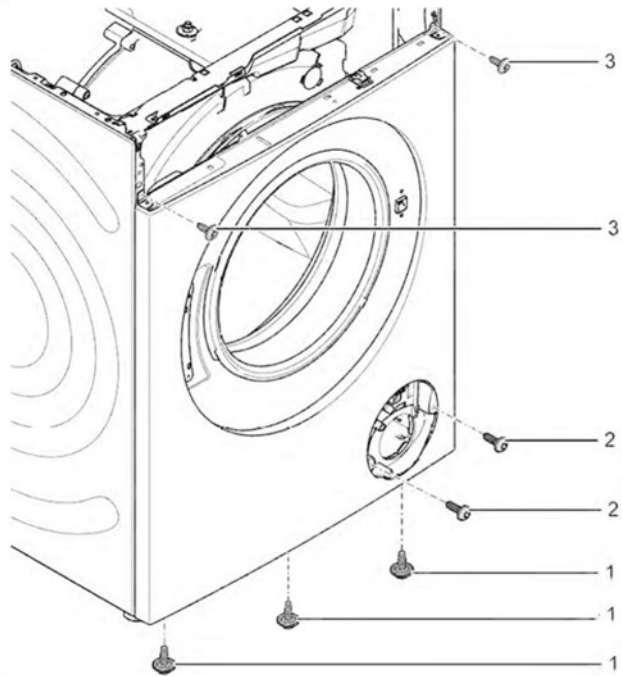



8. Αφαιρέστε το μπροστινό πλαίσιο.

4.11.2 Τοποθέτηση μπροστινής μετώπης

- ▶ Εγκαταστήστε με την αντίθετη σειρά.

Javítási útmutató - Mosógép

 A dokumentummal kapcsolatos információk.....	245
1.1 Fontos tudnivalók	245
1.1.1 Cél	245
1.2 Szimbólummagyarázat	245
1.2.1 Veszélyességi szintek	245
1.2.2 Veszélyt jelző szimbólumok	245
1.2.3 A figyelmeztetések felépítése	246
1.2.4 Általános szimbólumok.....	246
 Biztonság	247
2.1 Általános biztonsági utasítások.....	247
2.1.1 Összes háztartási készülék	247
 Szerszámok és segédanyagok.....	248
 Javítás	249
4.1 A felső burkolat cseréje.....	249
4.1.1 A felső burkolat eltávolítása	249
4.1.2 A felső burkolat elhelyezése	249
4.2 A vezérlőpanel cseréje.....	250
4.2.1 A vezérlőpanel eltávolítása	250
4.2.2 A vezérlőpanel telepítése	250
4.3 A mosószer-adagoló cseréje	251
4.3.1 A mosószer-adagoló eltávolítása	251
4.3.2 A mosószer-adagoló behelyezése.....	251
4.4 A mosószer-adagoló fogantyújának cseréje	252
4.4.1 A mosószer-adagoló fogantyújának eltávolítása.....	252
4.4.2 A mosószer-adagoló fogantyújának behelyezése.....	252
4.5 Az ajtó cseréje.....	253
4.5.1 Az ajtó eltávolítása	253
4.5.2 Az ajtó felhelyezése	253
4.6 Az ajtó alkatrészeinek cseréje	254
4.6.1 Az ajtó alkatrészeinek eltávolítása.....	254
4.6.2 Az ajtó alkatrészeinek felhelyezése	254
4.7 A gumitömítés cseréje	255
4.7.1 A gumitömítés eltávolítása.....	255
4.7.2 Gumitömítés felhelyezése	258

4.8 Ajtózár cseréje	259
4.8.1 Az ajtózár eltávolítása	259
4.8.2 Az ajtózár behelyezése	260
4.9 A belső dobvilágítás cseréje	261
4.9.1 A belső dobvilágítás eltávolítása.....	261
4.9.2 A belső dobvilágítás telepítése	261
4.10 A szivattyúfedél cseréje.....	262
4.10.1 A szivattyúfedél eltávolítása	262
4.10.2 A szivattyúfedél telepítése.....	262
4.11 Az elülső panel cseréje.....	263
4.11.1 Az elülső panel eltávolítása	263
4.11.2 Az elülső panel telepítése	265

i A dokumentummal kapcsolatos információk

1.1 Fontos tudnivalók

1.1.1 Cél

Ezek a javítási tanácsok támogatják a fogyasztót a készülékek otthoni megjavításában a környezettudatos tervezésről szóló rendeletnek (2021 márciusától alkalmazandó) megfelelően.

Információkat tartalmaznak bizonyos pótalkatrészek cseréjével kapcsolatban, ideértve a figyelmeztetéseket és a kockázatokat is.

Ha kérdése van, vegye fel a kapcsolatot a vevőszolgálattal. A károkért kizárólag akkor vállalunk felelősséget, ha a javítási tanácsokat pontosan betartották.

1.2 Szimbólummagyarázat

1.2.1 Veszélyességi szintek

A veszélyességi szintek egy szimbólumból és egy figyelmeztető mondatból állnak. A figyelmeztető mondat utal a veszély súlyosságára.





Veszélyességi szint	Jelentés
 VESZÉLY	A figyelmeztető üzenet figyelmen kívül hagyása halált vagy súlyos sérüléseket okoz.
 FIGYELMEZTETÉS	A figyelmeztető üzenet figyelmen kívül hagyása halált vagy súlyos sérüléseket okozhat.
 VIGYÁZAT	A figyelmeztető üzenet figyelmen kívül hagyása kisebb sérüléseket okozhat.
 FIGYELEM!	A figyelmeztető üzenet figyelmen kívül hagyása anyagi károkat okozhat.

Táblázat 1: Veszélyességi szintek

1.2.2 Veszélyt jelző szimbólumok

A veszélyt jelző szimbólumok a veszélyt ábrázoló szimbolikus ábrázolások.

A jelen dokumentumban az alábbi veszélyt jelző szimbólumok használatosak:

Veszélyt jelző szimbólum	Jelentés
	Általános figyelmeztető üzenet
	Elektromos feszültség veszélye
	Robbanásveszély
	Vágásveszély
	Zúzódásveszély

i A dokumentummal kapcsolatos információk

Veszélyt jelző szimbólum	Jelentés
	Forró felületek miatt fennálló veszély
	Erős mágneses mező miatt fennálló veszély
	Nem ionizáló sugárzás veszélye

Táblázat 2: Veszélyt jelző szimbólumok

1.2.3 A figyelmeztetések felépítése

A jelen dokumentumban lévő figyelmeztetések szabványosított megjelenésűek és felépítésűek.

	<p>⚠ VESZÉLY</p> <p>A veszély típusa és forrása! A veszély / figyelmeztetés figyelmen kívül hagyásának lehetséges következményei.</p> <ul style="list-style-type: none"> ▶ A veszély megelőzésére szolgáló intézkedések és tiltások.
--	---

Az alábbi példa egy olyan figyelmeztetést mutat be, amely az áram alatt lévő alkatrészek okozta áramütésre figyelmeztet. Megemlíti a veszély elkerülésére szolgáló intézkedést.

	<p>⚠ VESZÉLY</p> <p>Áramütés veszélye áram alatt lévő alkatrészek miatt! Halálos áramütés</p> <ul style="list-style-type: none"> ▶ A javítás megkezdése előtt legalább 60 másodperccel válassza le a készülékeket az elektromos hálózatról.
--	--

1.2.4 Általános szimbólumok

A jelen dokumentumban az alábbi általános szimbólumok használatosak:

Ált. szimbólum	Jelentés
	Különleges tanács (szöveg és/vagy grafika)

Ált. szimbólum	Jelentés
	Egyszerű tanács (csak szöveg)
	Videós oktatóanyagra mutató hivatkozás
	A szükséges eszközök
	A szükséges feltételek
	Feltétel (ha..., akkor...)
	Eredmény
[Indítás]	Billentyű vagy gomb
[00123456]	Anyagszám azonosítója
Állapot	Megjelenített szöveg / ablak (a készülék kijelzőjén)

Táblázat 3: Általános szimbólumok

2.1 Általános biztonsági utasítások

2.1.1 Összes háztartási készülék

Áramütés veszélye áram alatt lévő alkatrészek miatt!

- Az elektromos alkatrészek hibás javítása áramütéshez vezethet!
- A javítás megkezdése előtt legalább 60 másodperccel válassza le a készüléket az elektromos hálózatról.
- A javítás után végeztesse a VDE 0701-nek vagy az országspecifikus szabályozásoknak megfelelő vizsgálatot.

Éles peremek miatt fennálló sérülésveszély!

- Viseljen védőkesztyűt.

Zúzódásveszély a javítás, karbantartás, hibaelhárítás és szervizelés során a nehéz és mozgó alkatrészek miatt

- Viseljen védőcipőt.
- Biztosítsa leesés ellen a nehéz alkatrészeket.
- Ne dugja be a testrészeit a mozgó alkatrészek közé.







Sérülhet a készülék biztonsága / működése!



- Kizárólag eredeti pótalkatrészeket használjon.

Elektrosztatikailag érzékeny alkatrészek (ESD-k) károsodásának veszélye!

- Ne érintse meg a modulokat, ideértve a csatlakozásokat és a vezetőket.

Szerszámok és segédanyagok

Kijelölés	Részletek	Képek
Segédeszköz [15000155]	Műanyag alkatrészek meglazítására szolgáló szerszám	
Biztonsági Torx T20 csavarhúzó [00340764]	100°mm, biztonsági csavarokhoz	
Nyomatékkulcs [15000441]	Nyomatékkulcs 20–100 Nm	
Lapos csavarhúzó [00340854]	Fej: 3,5 mm x 0,6 mm x 100 mm, Szigetelés: 1000 V AC	
Lapos csavarhúzó [00340855]	Fej: 5,5 mm x 1,0 mm x 125 mm, Szigetelés: 1000 V AC	
Hosszúcsőrű fogó, hajlított kialakítás [00341269]	Hossz: 200 mm	
Oldalcsípő fogó [00342182]	Hossz: 200 mm	
Csillag-Villáskulcs [00340811]	Méret 10°mm, M6	



Kijelölés	Részletek	Képek
Combination wrench [00340814]	Méret 13°mm, M8	
Csillag-Villáskulcs [00340817]	Méret 17 mm, M10	
Csillag-Villáskulcs [15000459]	Méret 16°mm, M10	

4.1 A felső burkolat cseréje

Különleges eszközök

-  Torx Bit TX20, furatos, hosszú 6,3°mm (1/4") 152°mm, biztonsági bithegy csavarokhoz [00341272]

Követelmény:

-  A készüléket leválasztotta az áramellátásról.
-  A készüléket leválasztotta a vízellátásról.

4.1.1 A felső burkolat eltávolítása

- ▶ 1. Távolítsa el a csavarokat (1).
- ▶ 2. Tolja a felső burkolatot a készülék hátsó része felé (2).
- ▶ 3. Felemelve (3) távolítsa el a felső burkolatot.

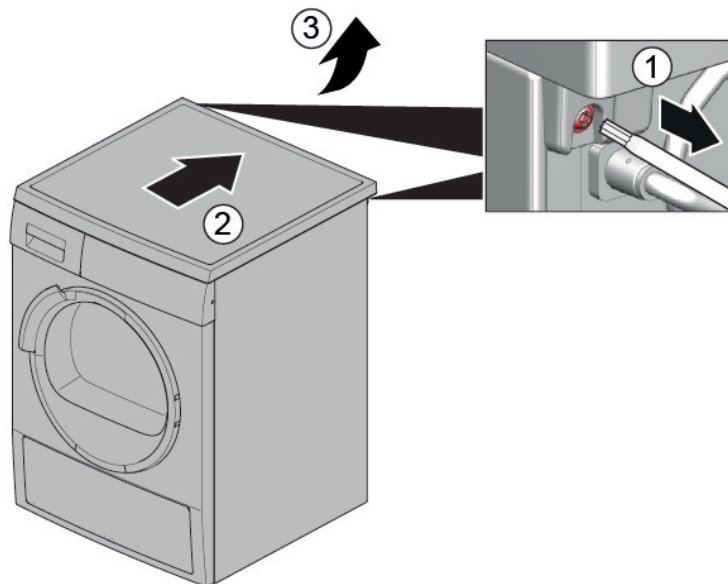

4.1.2 A felső burkolat elhelyezése

- ▶ Az elhelyezést fordított sorrendben végezze.

4.2 A vezérlőpanel cseréje



VIGYÁZAT

Éles burkolatszélek!
Vágási sérülések
▶ Viseljen védőkesztyűt.



FIGYELMEZTETÉS

Megdöntött készülékek elcsúszása!
Csonttörés / zúzódási sérülések
▶ Biztosítsa a készülékeket elcsúszás ellen.



VIGYÁZAT





Leeső alkatrészek veszélye a kioldott csavarok miatt!
Leeső alkatrészek miatti sérülés.
▶ Biztosítsa az alkatrészt leesés ellen.



FIGYELEM!

Leeső alkatrészek veszélye a kioldott csavarok miatt!
A készülék többi részeinek vagy az ügyfél lakásának (pl. padló) károsodása.
▶ Biztosítsa az alkatrészt leesés ellen.

Követelmény:

-  A készüléket leválasztotta az áramellátásról.
-  A készüléket leválasztotta a vízellátásról.
-  [Eltávolította a felső burkolatot.→249](#)
-  [Eltávolította a mosószer-adagolót.→251](#)

4.2.1 A vezérlőpanel eltávolítása

1. 1. Távolítsa el a csavarokat (1).
2. Lazítsa meg a rögzítőelemeket (2, 3).

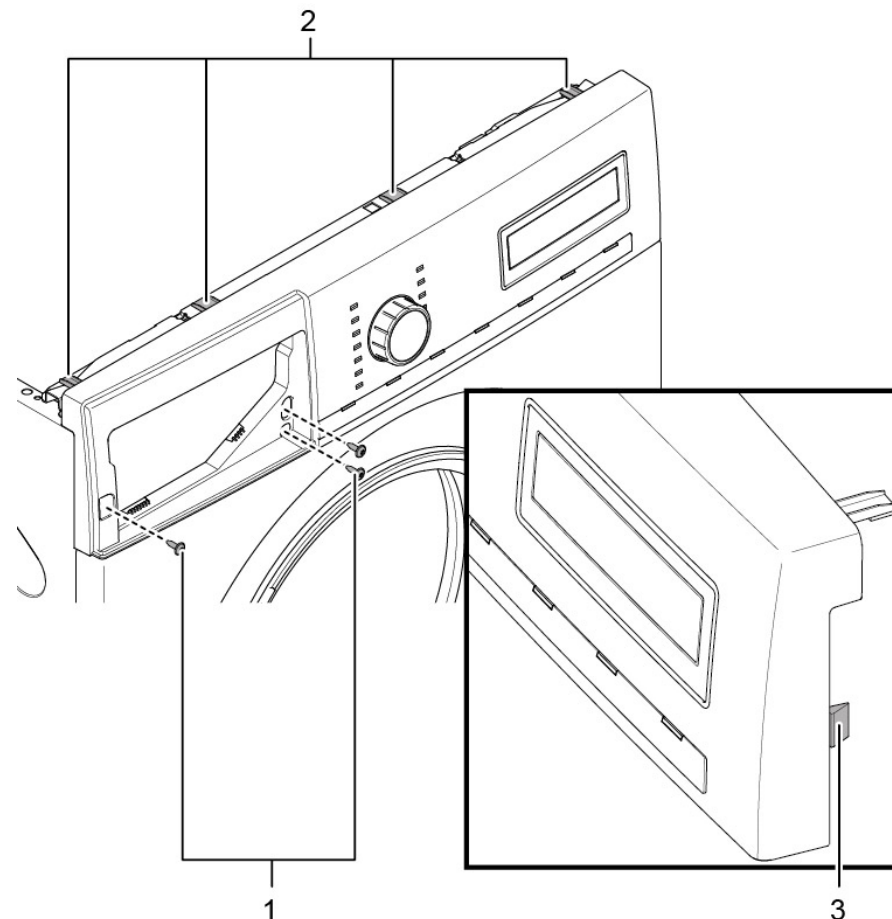

2. Húzza ki a vezérlőegység dugaszát.
3. Távolítsa el a vezérlőpanelt.

4.2.2 A vezérlőpanel telepítése

- ▶ Az elhelyezést fordított sorrendben végezze.

4.3 A mosószer-adagoló cseréje

Követelmény:

- ✓ A készüléket leválasztotta az áramellátásról.
- ✓ A készüléket leválasztotta a vízellátásról.

4.3.1 A mosószer-adagoló eltávolítása

1. Húzza ki a mosószer-adagoló rekeszt.
2. 1. Nyomja le a fiókot (1).
2. Távolítsa el a mosószer-adagoló rekeszt (2).

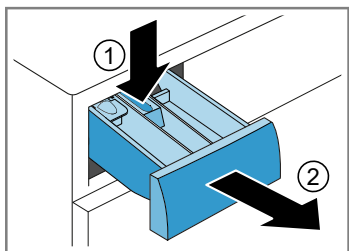

4.3.2 A mosószer-adagoló behelyezése

- ▶ Az elhelyezést fordított sorrendben végezze.

4.4 A mosószer-adagoló fogantyújának cseréje

Követelmény:

- ✔ A készüléket leválasztotta az áramellátásról.
- ✔ A készüléket leválasztotta a vízellátásról.
- ✔ [Eltávolította a mosószer-adagolót.→251](#)

4.4.1 A mosószer-adagoló fogantyújának eltávolítása

1. Lazítsa meg a rögzítőelemeket.

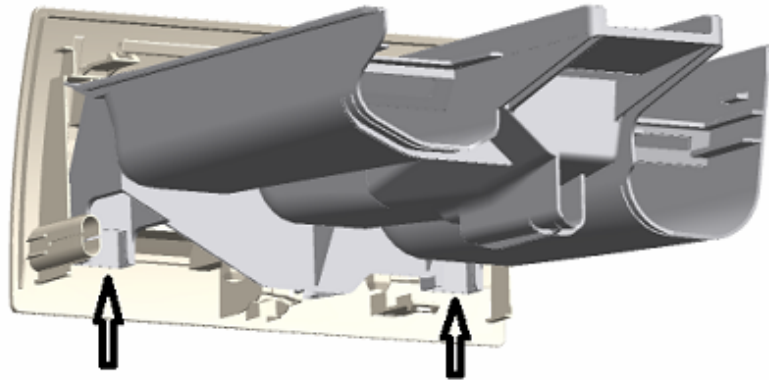

2. Távolítsa el a mosószer-adagoló rekesz fogantyúját.

4.4.2 A mosószer-adagoló fogantyújának behelyezése

- ▶ Az elhelyezést fordított sorrendben végezze.

4.5 Az ajtó cseréje



VIGYÁZAT

Nyitott zsanér!

Ujjak zúzódása/beszorulása

- ▶ Ne nyúljon be a nyitott zsanérba.
- ▶ Viseljen védőkesztyűt.

Követelmény:

- ✔ A készüléket leválasztotta az áramellátásról.
- ✔ A készüléket leválasztotta a vízellátásról.
- ✔ Az ajtó nyitva van.

4.5.1 Az ajtó eltávolítása

1.



FIGYELEM!

Leeső alkatrészek veszélye a kioldott csavarok miatt!

A készülék többi részeinek vagy az ügyfél lakásának (pl. padló) károsodása.

- ▶ Biztosítsa az alkatrészt leesés ellen.



VIGYÁZAT

Leeső alkatrészek veszélye a kioldott csavarok miatt!

Leeső alkatrészek miatti sérülés.

- ▶ Biztosítsa az alkatrészt leesés ellen.

Távolítsa el a csavarokat (1).

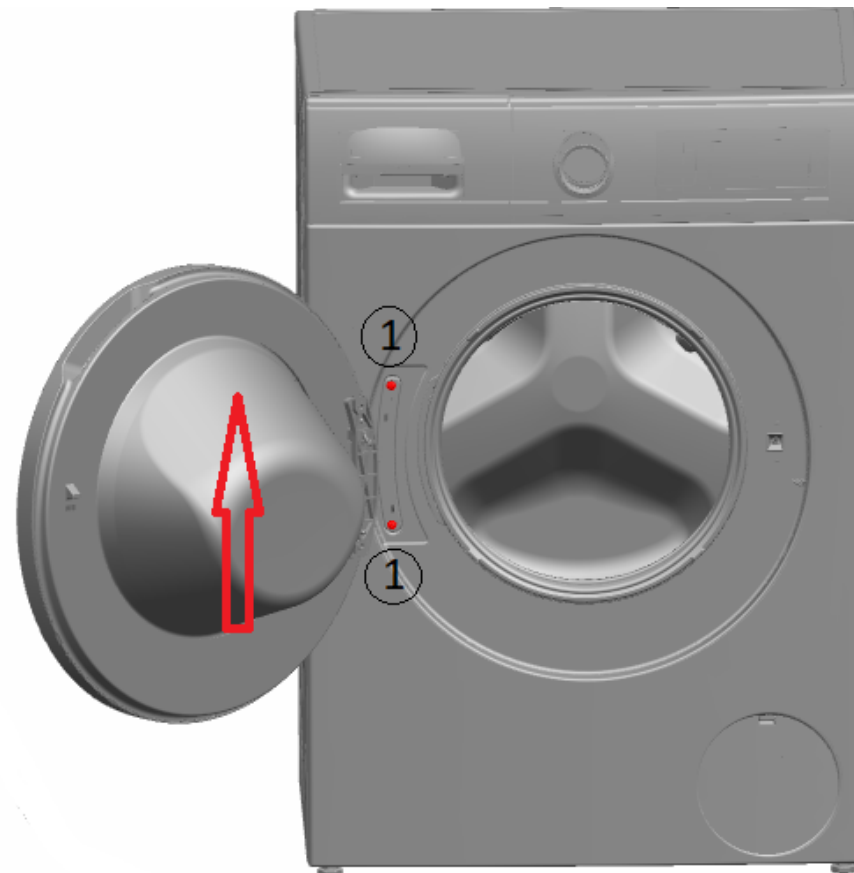

2. Felfelé húzva távolítsa el az ajtót.

4.5.2 Az ajtó felhelyezése

- ▶ Az elhelyezést fordított sorrendben végezze.

4.6 Az ajtó alkatrészeinek cseréje

	<p>⚠ VIGYÁZAT</p> <p>Nyitott zsanér! Ujjak zúzódása/beszorulása</p> <ul style="list-style-type: none">▶ Ne nyúljon be a nyitott zsanérba.▶ Viseljen védőkesztyűt.
--	--

Követelmény:

- ✓ A készüléket leválasztotta az áramellátásról.
- ✓ A készüléket leválasztotta a vízellátásról.
- ✓ [Eltávolította az ajtót.→253](#)

4.6.1 Az ajtó alkatrészeinek eltávolítása

- ▶ Kívülről befelé haladva szerelje szét az ajtót.

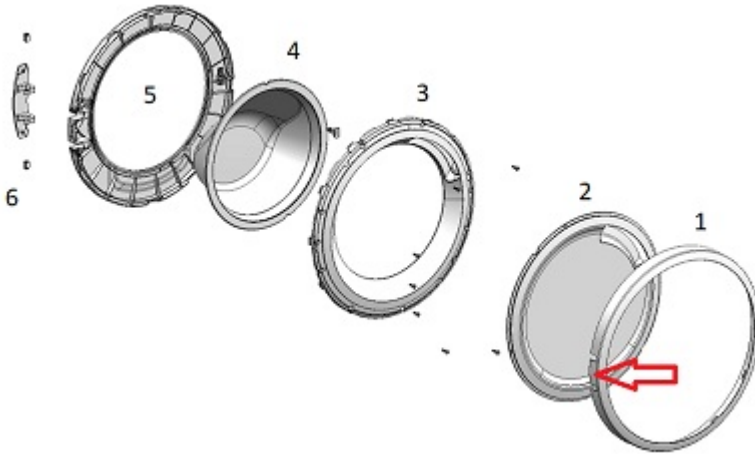

4.6.2 Az ajtó alkatrészeinek felhelyezése

- ▶ Az elhelyezést fordított sorrendben végezze.

4.7 A gumitömítés cseréje



VIGYÁZAT

Éles burkolatszélék!
Vágási sérülések
▶ Viseljen védőkesztyűt.



VIGYÁZAT

Leeső alkatrészek veszélye a kioldott csavarok miatt!
Leeső alkatrészek miatti sérülés.
▶ Biztosítsa az alkatrészt leesés ellen.



FIGYELEM!

Leeső alkatrészek veszélye a kioldott csavarok miatt!
A készülék többi részeinek vagy az ügyfél lakásának (pl. padló) károsodása.
▶ Biztosítsa az alkatrészt leesés ellen.

Követelmény:

- ✓ A készüléket leválasztotta az áramellátásról.
- ✓ A készüléket leválasztotta a vízellátásról.
- ✓ [Eltávolította a mosószer-adagolót.→251](#)
- ✓ [Eltávolította az ajtót.→253](#)
- ✓ [Eltávolította a szivattyúfedelelet.→262](#)

4.7.1 A gumitömítés eltávolítása

1.



FIGYELMEZTETÉS

Megdöntött készülékek elcsúszása!
Csonttörés / zúzódási sérülések
▶ Biztosítsa a készülékeket elcsúszás ellen.

Emelje fel elől a készüléket.

2. Lazítsa meg a csavarokat az elülső panel alján (1).

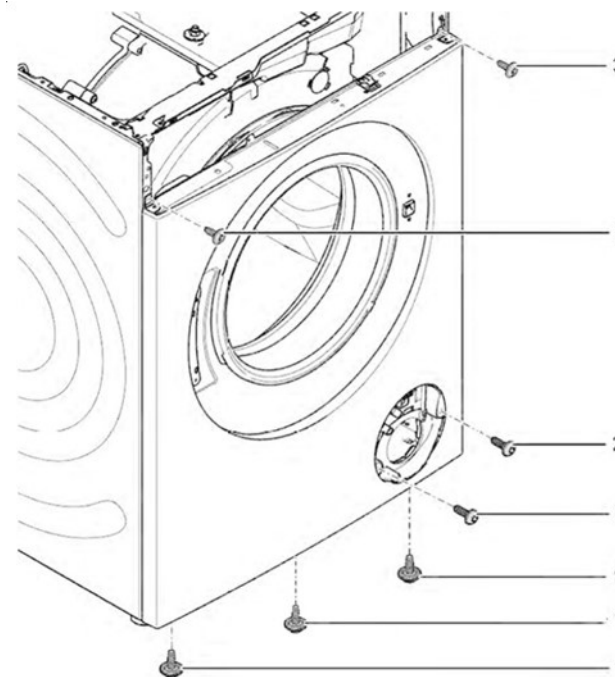

3. Engedje le a készüléket.

4. Távolítsa el a szivattyúnál (2) lévő csavarokat.

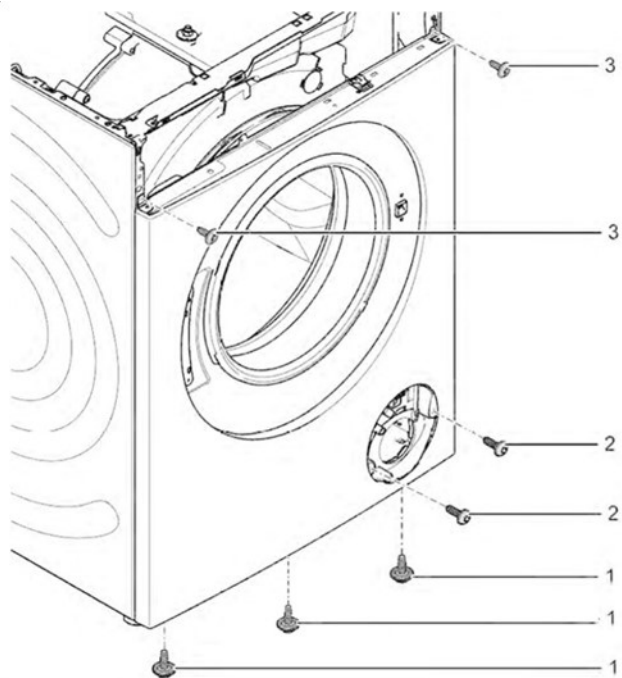

5. 1. Lazítsa meg a készülék hátsó részén (1) lévő csavarokat.
2. Távolítsa el a felső burkolatot (2, 3).

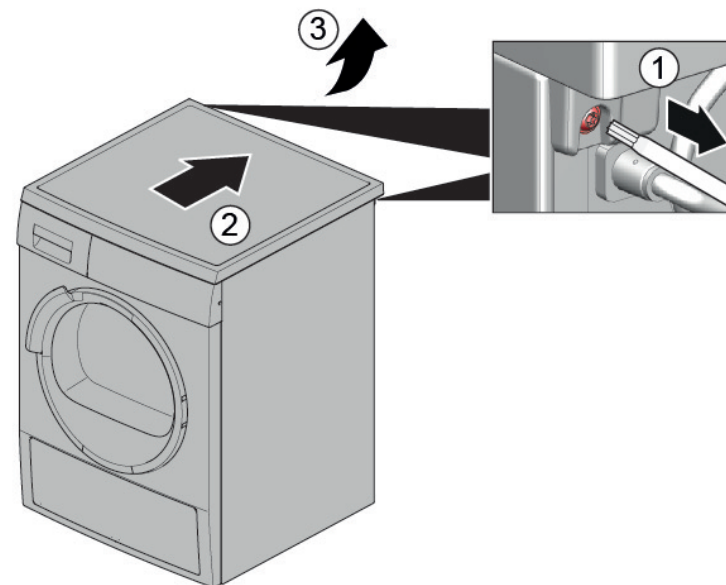

6. 1. Távolítsa el a csavarokat (1).
2. Lazítsa meg a vezérlőpanel rögzítőelemeit (2, 3).
3. Lazítsa meg a mosószer-adagoló házának csavarjait.

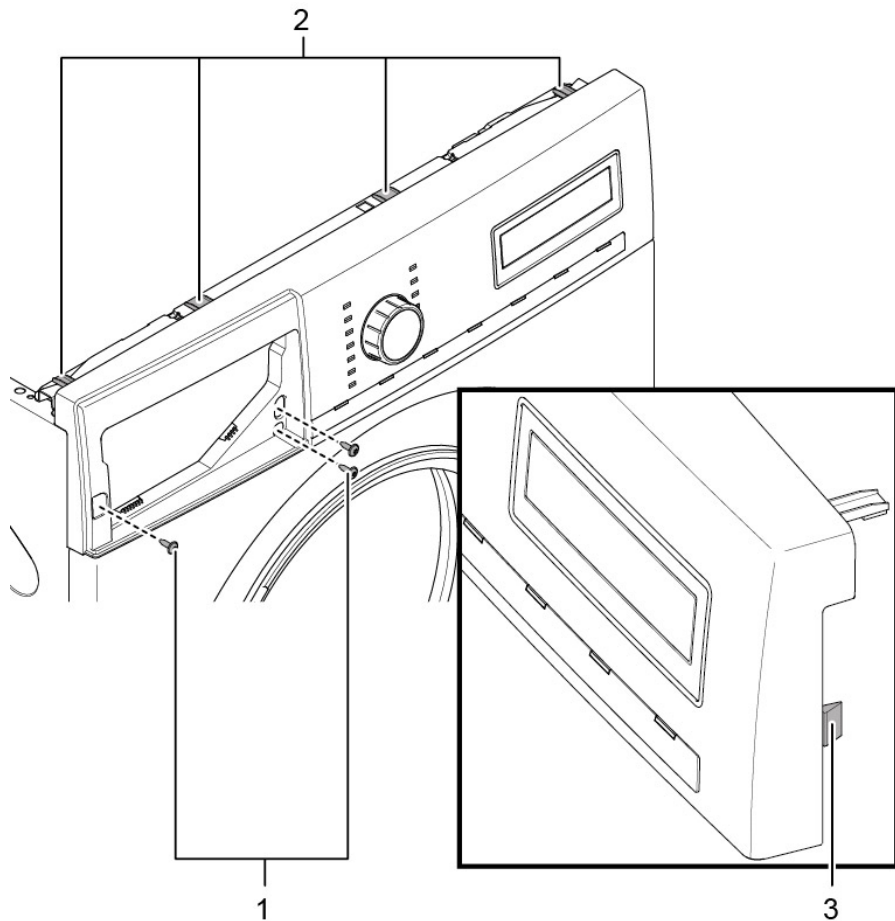

7. Távolítsa el a vezérlőpanelt.

8. Távolítsa el a belső dobvilágítás tartóját fent.

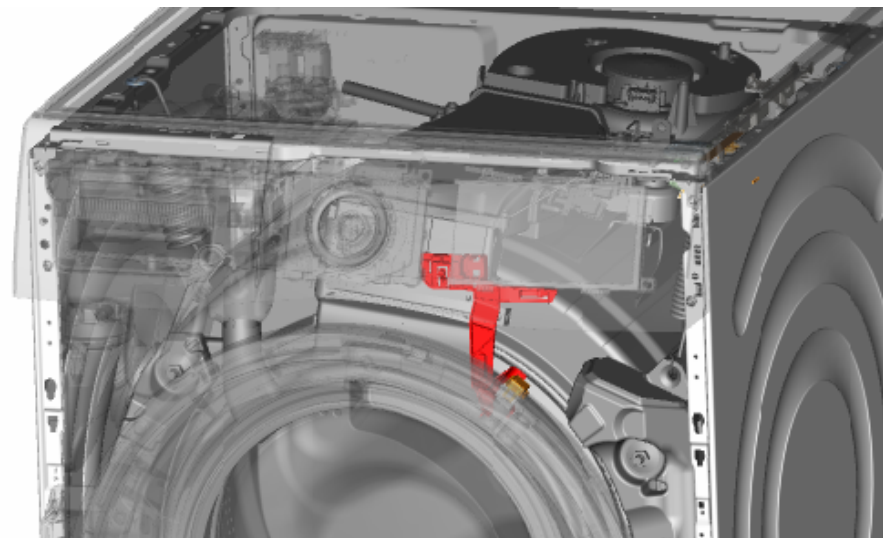

- 9.



FIGYELEM!

Sérült felület kockázata!

A helytelen szerszámok használatával megkarcolhatja a készülék felületét.

- ▶ A fessítőgyűrű eltávolításához kizárólag műanyag szerszámokat használjon.

Távolítsa el a fessítőgyűrűt a tömítésből egy műanyag szerszámmal.

10. Vegye ki a tömítést az elülső panelből.
11. Vegye ki a kábelcsatlakozót az ajtózárból.

12. Lazítsa meg a csavarokat az elülső panel tetején (3).

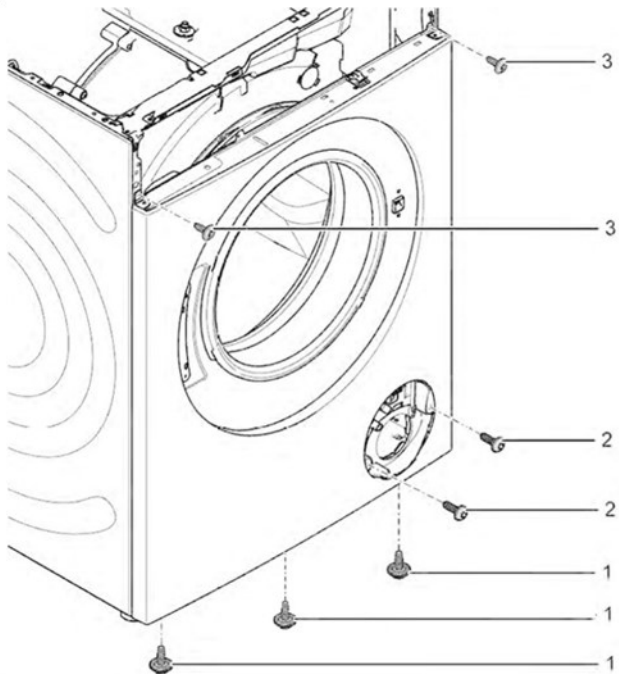

13. Távolítsa el az elülső panelt.

14. Szüntesse meg a tömlőcsatlakozásokat.

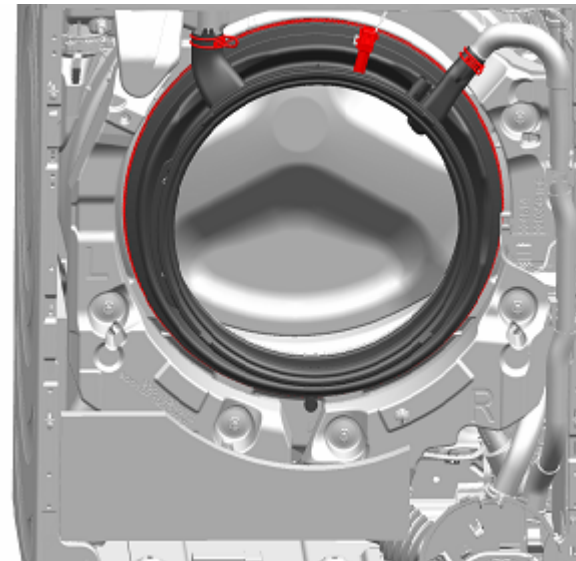

15. Távolítsa el a gumitömítést.

4.7.2 Gumitömítés felhelyezése



FIGYELMEZTETÉS

Leeső alkatrészek veszélye a nem megfelelő telepítés miatt!

Sérülés vagy a készülék károsodásának veszélye

▶ Húzza meg az üstszejgumi szorítógyűrűjét 3,4 Nm nyomatékkal.

▶ Az elhelyezést fordított sorrendben végezze.

4.8 Ajtózár cseréje

Gyártóként kötelességünk tartalék alkatrészként ajtózárat biztosítani a vásárlók számára, beleértve a javítási utasításokat is a 2019/2023 EU-rendeletnek megfelelően. Felhívjuk a figyelmét, hogy az ajtózár cseréje után egy képzett elektroműszerésznek elektrotechnikai biztonsági vizsgálatot kell végeznie a készülék üzembe helyezése előtt. A vizsgálatot végző személynek az adott ország törvényei, szabályozásai és szabványai szerint meghatározott képesítéssel kell rendelkeznie.

	⚠ VESZÉLY Áramütés veszélye áram alatt lévő alkatrészek miatt! Életveszély a nem megfelelő javítás okozta áramütés miatt <ul style="list-style-type: none">▶ Az elektromos alkatrészek javítását kizárólag képzett elektroműszerész végezheti.▶ A javítás után végeztessen a VDE 0701-nek vagy az országspecifikus szabályozásoknak megfelelő vizsgálatot.
	⚠ VIGYÁZAT Éles burkolatszélék! Vágási sérülések <ul style="list-style-type: none">▶ Viseljen védőkesztyűt.
	⚠ FIGYELMEZTETÉS Megdöntött készülékek elcsúszása! Csonttörés / zúzódási sérülések <ul style="list-style-type: none">▶ Biztosítsa a készülékeket elcsúszás ellen.
	⚠ VIGYÁZAT Leeső alkatrészek veszélye a kioldott csavarok miatt! Leeső alkatrészek miatti sérülés. <ul style="list-style-type: none">▶ Biztosítsa az alkatrészt leesés ellen.
	FIGYELEM! Leeső alkatrészek veszélye a kioldott csavarok miatt! A készülék többi részeinek vagy az ügyfél lakásának (pl. padló) károsodása. <ul style="list-style-type: none">▶ Biztosítsa az alkatrészt leesés ellen.

Követelmény:

- ✓ A készüléket leválasztotta az áramellátásról.

- ✓ A készüléket leválasztotta a vízellátásról.
- ✓ A készülékek szabadon hozzáférhetők.
- ✓ [Eltávolította a felső burkolatot. →249](#)
- ✓ A vezérlőpanelt eltávolították.
- ✓ [Eltávolította az ajtót. →253](#)
- ✓ A feszítőgyűrűt eltávolították.
- ✓ Az elülső panelt eltávolították.
- ✓ A gumitömítést eltávolították.

4.8.1 Az ajtózár eltávolítása

1. Válassza le az ajtózár csatlakozóját.
2. Lazítsa meg az ajtózárat.



3. Vegye ki az ajtózárat.

4.8.2 Az ajtózár behelyezése

Az ajtózárnak megfelelő pozícióban kell lennie ahhoz, hogy a vészhelyzeti ajtónyitás működőképes legyen.



- ▶ Az elhelyezést fordított sorrendben végezze.

4.9 A belső dobvilágítás cseréje



VIGYÁZAT

Éles burkolatszélek!
Vágási sérülések
▶ Viseljen védőkesztyűt.



FIGYELMEZTETÉS

Megdöntött készülékek elcsúszása!
Csonttörés / zúzódási sérülések
▶ Biztosítsa a készülékeket elcsúszás ellen.



VIGYÁZAT

Leeső alkatrészek veszélye a kioldott csavarok miatt!
Leeső alkatrészek miatti sérülés.
▶ Biztosítsa az alkatrészt leesés ellen.



FIGYELEM!

Leeső alkatrészek veszélye a kioldott csavarok miatt!
A készülék többi részeinek vagy az ügyfél lakásának (pl. padló) károsodása.
▶ Biztosítsa az alkatrészt leesés ellen.

Követelmény:

- ✓ A készüléket leválasztotta az áramellátásról.
- ✓ A készüléket leválasztotta a vízellátásról.
- ✓ A készülékek szabadon hozzáférhetők.
- ✓ [Eltávolította a felső burkolatot.→249](#)
- ✓ [Eltávolította a mosószer-adagolót.→251](#)
- ✓ A vezérlőpanelt eltávolították.

4.9.1 A belső dobvilágítás eltávolítása

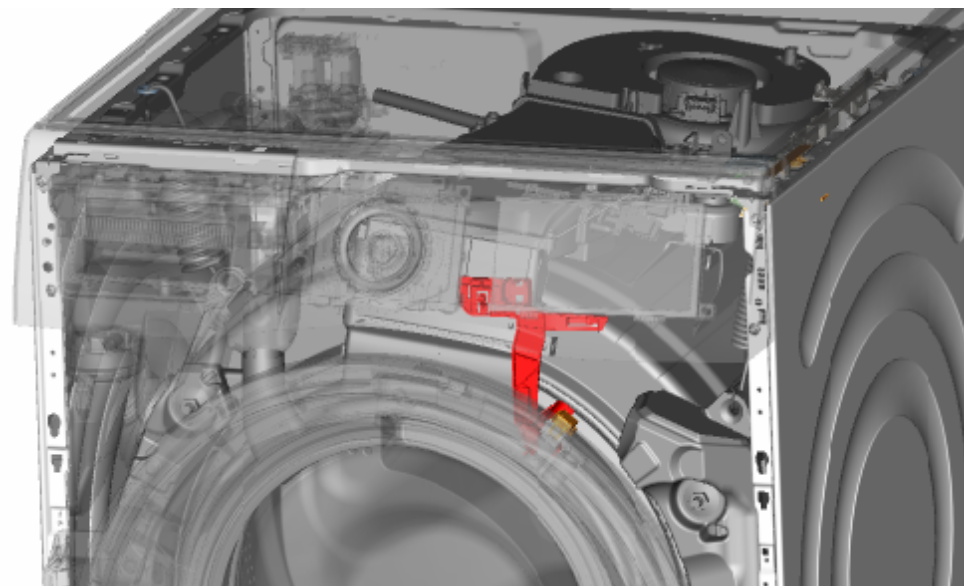

1. Húzza ki a belső dobvilágítás tartóját a készülékből.
2. Válassza le az elektromos csatlakozókat.
3. Távolítsa el a belső dobvilágítást a belső dobvilágítás tartójából.

4.9.2 A belső dobvilágítás telepítése

- ▶ Az elhelyezést fordított sorrendben végezze.

4.10 A szivattyúfedél cseréje

Követelmény:

- ✔ A készüléket leválasztotta az áramellátásról.
- ✔ A készüléket leválasztotta a vízellátásról.

4.10.1 A szivattyúfedél eltávolítása

1. Nyissa fel a szivattyú fedelét.

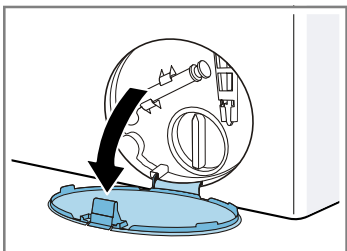

2. Távolítsa el a szivattyú fedelét.

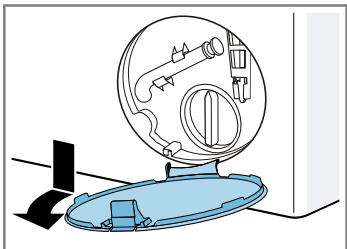

4.10.2 A szivattyúfedél telepítése

- ▶ Az elhelyezést fordított sorrendben végezze.

4.11 Az elülső panel cseréje



VIGYÁZAT

Éles burkolatszélék!

Vágási sérülések

- ▶ Viseljen védőkesztyűt.

Követelmény:

- ✓ A készüléket leválasztotta az áramellátásról.
- ✓ A készüléket leválasztotta a vízellátásról.
- ✓ [Eltávolította a mosószer-adagolót.→251](#)
- ✓ [Eltávolította az ajtót.→253](#)
- ✓ A gumitömítést eltávolították.
- ✓ [Eltávolította a szivattyúfedelelet.→262](#)

4.11.1 Az elülső panel eltávolítása

1.



FIGYELMEZTETÉS

Megdöntött készülékek elcsúszása!

Csonttörés / zúzódási sérülések

- ▶ Biztosítsa a készülékeket elcsúszás ellen.

Emelje fel elől a készüléket.

2. Távolítsa el az aljáról csavarokat (1).

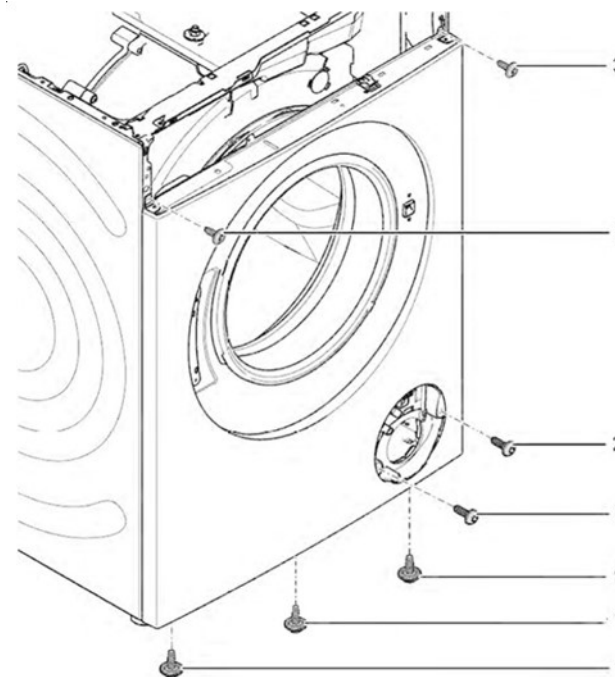

3. Engedje le a készüléket.

4. 1. Távolítsa el a csavarokat (1).
2. Tolja a felső burkolatot a készülék hátsó része felé (2).
3. Felemelve (3) távolítsa el a felső burkolatot.

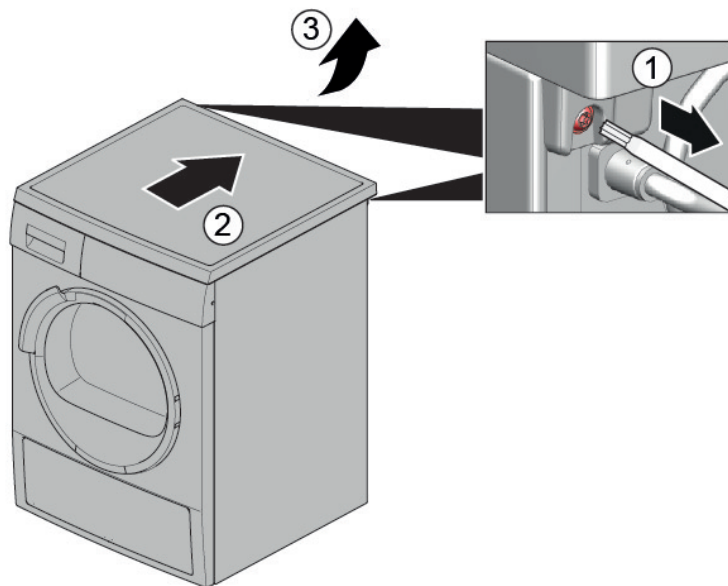

5. 1. Távolítsa el a csavarokat (1).
2. Lazítsa meg a rögzítőelemeket (2, 3).

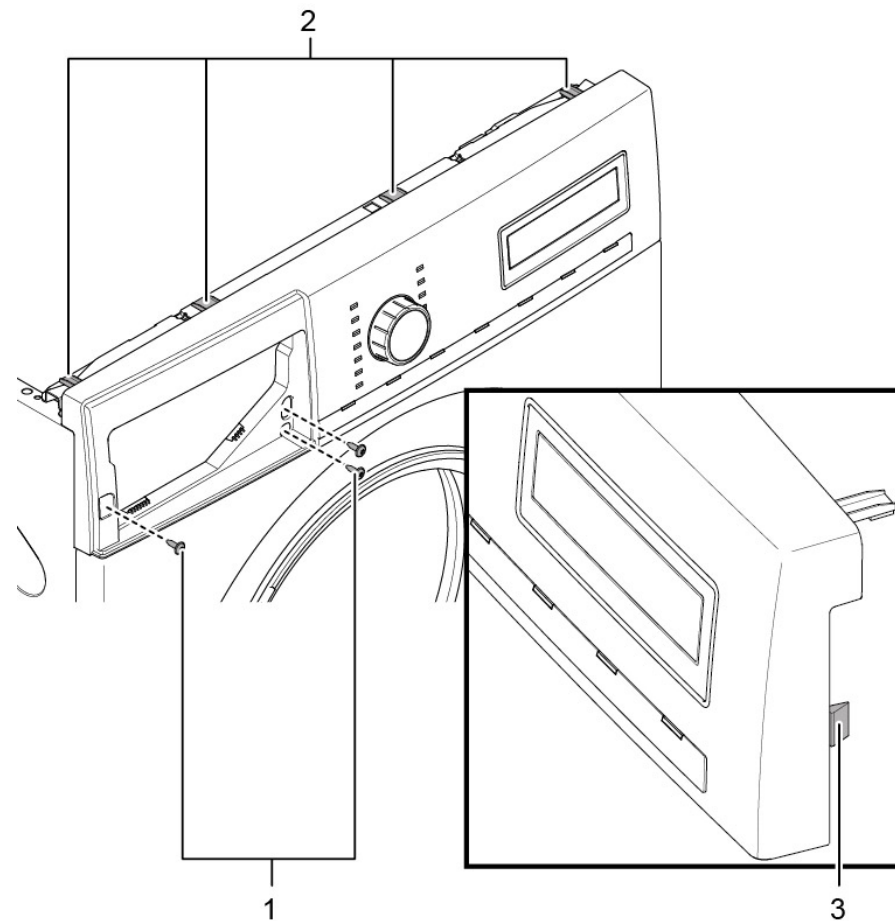

6. Távolítsa el a vezérlőpanelt.

7.



⚠ VIGYÁZAT

Leeső alkatrészek veszélye a kioldott csavarok miatt!

Leeső alkatrészek miatti sérülés.

- ▶ Biztosítsa az alkatrészt leesés ellen.



FIGYELEM!

Leeső alkatrészek veszélye a kioldott csavarok miatt!

A készülék többi részeinek vagy az ügyfél lakásának (pl. padló) károsodása.

- ▶ Biztosítsa az alkatrészt leesés ellen.

Távolítsa el a csavarokat az elejéről, haladjon alulról felfelé (2, 3).

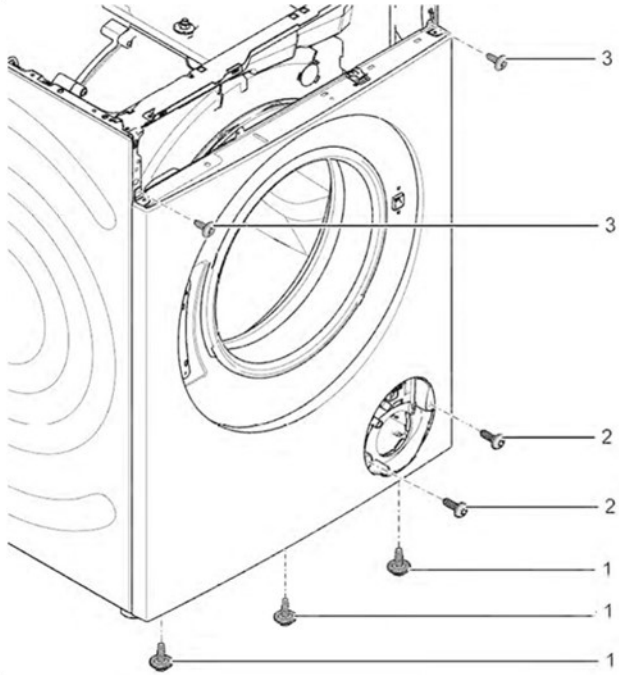

8. Távolítsa el az elülső panelt.

4.11.2 Az elülső panel telepítése

- ▶ Az elhelyezést fordított sorrendben végezze.

Consigli di riparazione - Lavatrice

Utilizzo del documento 267

1.1	Avvertenze importanti	267
1.1.1	Scopo	267
1.2	Spiegazione dei simboli	267
1.2.1	Livelli di pericolo	267
1.2.2	Simboli di pericolo	267
1.2.3	Struttura degli avvertimenti	268
1.2.4	Simboli generici	268

Sicurezza 269

2.1	Note generali sulla sicurezza	269
2.1.1	Tutti gli elettrodomestici	269

Strumenti e ausili 270

Riparazione 271

4.1	Sostituzione del piano di lavoro	271
4.1.1	Smontaggio del piano di lavoro	271
4.1.2	Montaggio del piano di lavoro	271
4.2	Sostituzione del pannello comandi	272
4.2.1	Smontaggio del pannello comandi	272
4.2.2	Montaggio del pannello comandi	272
4.3	Sostituzione del cassetto del detersivo	273
4.3.1	Smontaggio del cassetto del detersivo	273
4.3.2	Montaggio del cassetto del detersivo	273
4.4	Sostituzione della maniglia del cassetto del detersivo	274
4.4.1	Smontaggio della maniglia del cassetto del detersivo	274
4.4.2	Montaggio della maniglia del cassetto del detersivo	274
4.5	Sostituzione dell'oblò	275
4.5.1	Smontaggio dell'oblò	275
4.5.2	Montaggio dell'oblò	275
4.6	Sostituzione dei componenti dell'oblò	276
4.6.1	Smontaggio dei componenti dell'oblò	276
4.6.2	Montaggio dei componenti dell'oblò	276
4.7	Sostituzione della guarnizione dell'oblò	277
4.7.1	Rimozione della guarnizione dell'oblò	277
4.7.2	Installazione della guarnizione dell'oblò	280

4.8	Sostituzione del blocco porta	281
4.8.1	Smontaggio del blocco porta	281
4.8.2	Montaggio del blocco porta	282
4.9	Sostituzione della luce del cestello	283
4.9.1	Smontaggio della luce del cestello	283
4.9.2	Montaggio della luce del cestello	283
4.10	Sostituzione della copertura della pompa	284
4.10.1	Smontaggio della copertura della pompa	284
4.10.2	Montaggio della copertura della pompa	284
4.11	Sostituzione del pannello frontale	285
4.11.1	Smontaggio del pannello frontale	285
4.11.2	Montaggio del pannello frontale	287

i Utilizzo del documento

1.1 Avvertenze importanti

1.1.1 Scopo

Queste istruzioni di riparazione spiegano ai clienti come riparare da soli gli elettrodomestici in conformità alle regole sull'Ecodesign vigenti (al 03/2021).

Contengono informazioni sulla sostituzione di pezzi di ricambio specifici e sulle avvertenze e i rischi correlati.

In caso di domande, contattare l'assistenza tecnica. Il mancato rispetto di tali istruzioni da parte dei clienti ci esonera da qualsiasi responsabilità.

1.2 Spiegazione dei simboli

1.2.1 Livelli di pericolo

I livelli di avvertimento corrispondono a un simbolo accompagnato da una parola di allerta. La parola di allerta identifica il livello di pericolo.





Livello di avvertimento	Significato
 PERICOLO	Ignorare questo messaggio di avvertimento comporta rischio di morte o ferite gravi.
 AVVERTENZA	Ignorare questo messaggio di avvertimento può comportare rischio di morte o ferite gravi.
 ATTENZIONE	Ignorare questo messaggio di avvertimento può comportare ferite di minore gravità.
 ATTENZIONE!	Ignorare questo messaggio di avvertimento può comportare danni materiali.

Tabella 1: Livelli di pericolo

1.2.2 Simboli di pericolo

I simboli di pericolo sono illustrazioni che specificano la tipologia di rischio.

Nella presente documentazione vengono utilizzati i seguenti simboli di pericolo:

Simbolo di pericolo	Significato
	Messaggio di avvertimento generico
	Pericolo di scossa elettrica
	Pericolo di esplosione
	Rischio di ferite da taglio

i Utilizzo del documento







Simbolo di pericolo	Significato
	Pericolo di schiacciamento
	Pericolo derivante da superfici calde
	Pericolo derivante da forti campi magnetici
	Pericolo derivante da radiazioni non ionizzanti

Tabella 2: Simboli di pericolo

1.2.3 Struttura degli avvertimenti

Gli avvertimenti presenti in questo manuale hanno una forma e una struttura standardizzati.

	<p> PERICOLO</p> <p>Tipo e origine del pericolo! Possibili conseguenze in caso di pericolo/avvertimento ignorato.</p> <ul style="list-style-type: none"> ▸ Misure e divieti volti a prevenire il pericolo.
--	--

L'esempio seguente mostra un avvertimento con rischio di folgorazione dovuto a componenti sotto tensione. È riportata la misura di precauzione per evitare il pericolo.

	<p> PERICOLO</p> <p>Rischio di scossa elettrica dovuto a componenti sotto tensione! Morte per folgorazione</p> <ul style="list-style-type: none"> ▸ Scollegare l'apparecchio dall'alimentazione per almeno 60 secondi prima di iniziare la riparazione.
--	---

1.2.4 Simboli generici

Nel presente manuale vengono utilizzati i seguenti simboli generici:



Simbolo generico	Significato
	Identificazione di un suggerimento speciale (testo e/o grafica)
	Identificazione di un suggerimento semplice (solo testo)
	Identificazione di un link per un video tutorial
	Identificazione degli strumenti necessari
	Identificazione delle condizioni preve necessarie
	Identificazione di una condizione (se ..., allora ...)
	Identificazione di un risultato
[Avvio]	Identificazione di un tasto o di un pulsante
[00123456]	Identificazione di un codice articolo
Stato	Identificazione di un testo/finestra visualizzati (sul display dell'apparecchio)

Tabella 3: Simboli generici

2.1 Note generali sulla sicurezza

2.1.1 Tutti gli elettrodomestici

Rischio di scosse elettriche dovute a componenti sotto tensione!

- La riparazione non conforme dei componenti elettrici può causare scosse elettriche!
- Scollegare l'apparecchio dall'alimentazione per almeno 60 secondi prima di iniziare il lavoro.
- Ultimata la riparazione, occorre eseguire un test di sicurezza conforme alla norma VDE 0701 o alle norme specifiche del Paese.

Rischio di lesioni causate da bordi taglienti!

- Indossare guanti di protezione.

Rischio di schiacciamento dovuto a componenti pesanti e in movimento durante la riparazione, la manutenzione, la ricerca dei guasti e l'assistenza

- Indossare calzature antinfortunistiche.
- Fissare i componenti pesanti per impedire che cadano.
- Non inserire parti del corpo nei componenti in movimento.







Rischio per il funzionamento o la sicurezza dell'apparecchio!





- Utilizzare solo ricambi originali.

Rischio di danneggiamento di componenti sensibili a carica elettrostatica (ESD)!

- Non toccare i moduli, inclusi i collegamenti e le piste conduttive.

Strumenti e ausili

Designazione	Dettagli	Immagini
Strumento ausiliario [15000155]	Utensile per allentare i componenti in plastica	
Cacciavite Torx T20 con foro [00340764]	100 mm, per viti con perno di sicurezza	
Chiave dinamometrica [15000441]	Chiave dinamometrica 20 - 100 Nm	
Cacciavite con punta piatta [00340854]	Lama 3,5 mm x 0,6 mm x 100 mm, isolamento di protezione 1000 V AC	
Cacciavite con punta piatta [00340855]	Lama 5,5 mm x 1,0 mm x 125 mm, isolamento di protezione 1000 V AC	
Pinze a becco tondo, struttura angolare [00341269]	Lunghezza 200 mm	
Pinze per taglio laterale [00342182]	Lunghezza: 200 mm	



Designazione	Dettagli	Immagini
Chiave combinata [00340811]	Dimensione della chiave 10°mm, M6	
Combination wrench [00340814]	Dimensione della chiave 13°mm, M8	
Chiave combinata [00340817]	Dimensione della chiave 17 mm, M10	
Chiave combinata [15000459]	Dimensione della chiave 16°mm, M10	

4.1 Sostituzione del piano di lavoro

Attrezzi speciali:

-  Punta Torx TX20 forata, lunga 6,3°mm (1/4") 152°mm, per viti con perno di sicurezza [00341272]

Prerequisiti:

-  L'apparecchio è scollegato dalla rete elettrica.
-  L'apparecchio è scollegato dalla rete idrica.

4.1.1 Smontaggio del piano di lavoro

- ▶ 1. Rimuovere le viti (1).
- ▶ 2. Far scorrere il piano di lavoro verso la parte posteriore dell'apparecchio (2).
- ▶ 3. Smontare il piano di lavoro tirandolo verso l'alto (3).

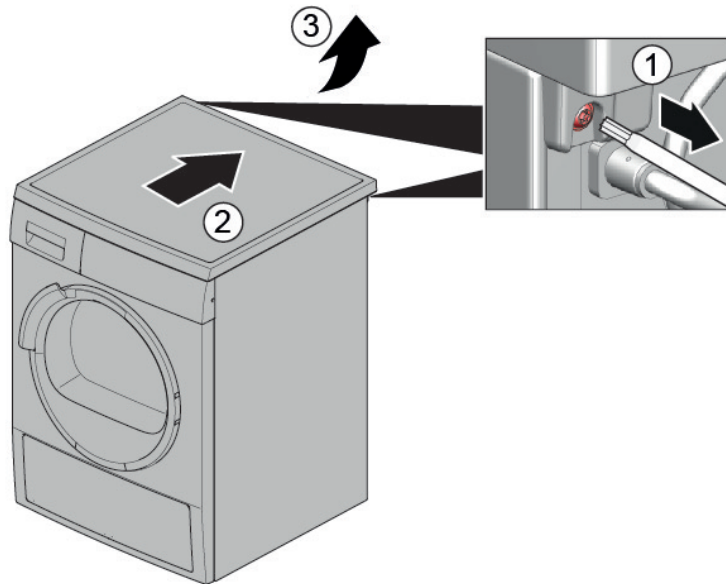

4.1.2 Montaggio del piano di lavoro

- ▶ Per il montaggio, seguire la procedura sopra descritta in senso opposto.

4.2 Sostituzione del pannello comandi



ATTENZIONE

Alloggiamento con spigoli vivi!

Ferite da taglio

- ▶ Indossare guanti di protezione.



AVVERTENZA

Gli apparecchi inclinati possono scivolare!

Fratture / lesioni da schiacciamento

- ▶ Fissare gli apparecchi in modo che non scivolino.



ATTENZIONE

Rischio di caduta di componenti a causa di viti allentate!

Lesioni provocate dalla caduta di componenti.

- ▶ Fissare i componenti in modo che non cadano.



ATTENZIONE!

Rischio di caduta di componenti a causa di viti allentate!

Danni a altre parti dell'apparecchio o all'abitazione del cliente, ad es. parte inferiore.

- ▶ Fissare i componenti in modo che non cadano.

Prerequisiti:

- ✓ L'apparecchio è scollegato dalla rete elettrica.
- ✓ L'apparecchio è scollegato dalla rete idrica.
- ✓ [Il piano di lavoro è stato smontato.→271](#)
- ✓ [Il cassetto del detersivo è stato rimosso.→273](#)

4.2.1 Smontaggio del pannello comandi

1. Rimuovere le viti (1).
2. Sganciare gli elementi di blocco (2, 3).

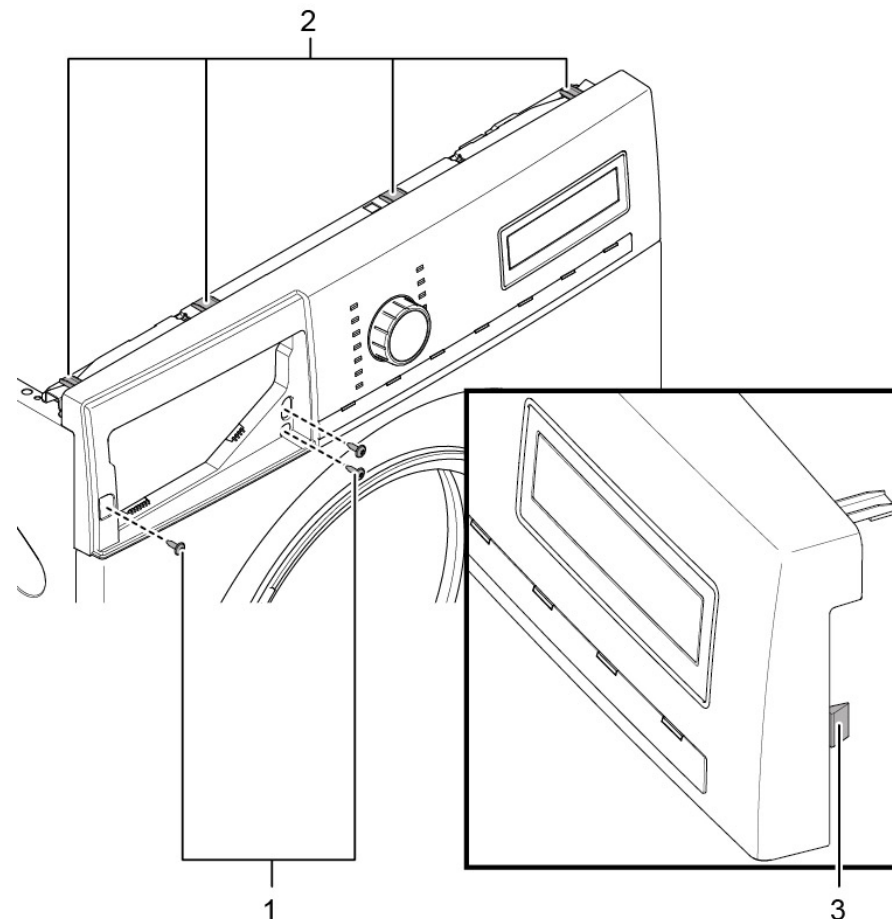

2. Allentare il contatto della spina dell'unità di controllo.
3. Smontare il pannello comandi.

4.2.2 Montaggio del pannello comandi

- ▶ Per il montaggio, seguire la procedura sopra descritta in senso opposto.

4.3 Sostituzione del cassetto del detersivo

Prerequisiti:

- ✓ L'apparecchio è scollegato dalla rete elettrica.
- ✓ L'apparecchio è scollegato dalla rete idrica.

4.3.1 Smontaggio del cassetto del detersivo

1. Estrarre il cassetto del detersivo.
2.
 1. Premere sulla linguetta (1).
 2. Rimuovere il cassetto del detersivo (2).

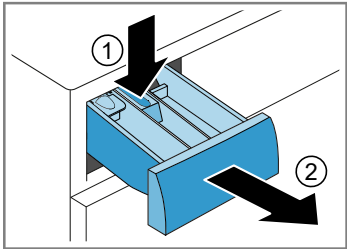

4.3.2 Montaggio del cassetto del detersivo

- ▶ Per il montaggio, seguire la procedura sopra descritta in senso opposto.

4.4 Sostituzione della maniglia del cassetto del detersivo

Prerequisiti:

- ✓ L'apparecchio è scollegato dalla rete elettrica.
- ✓ L'apparecchio è scollegato dalla rete idrica.
- ✓ [Il cassetto del detersivo è stato rimosso.→273](#)

4.4.1 Smontaggio della maniglia del cassetto del detersivo

1. Sganciare gli elementi di blocco.

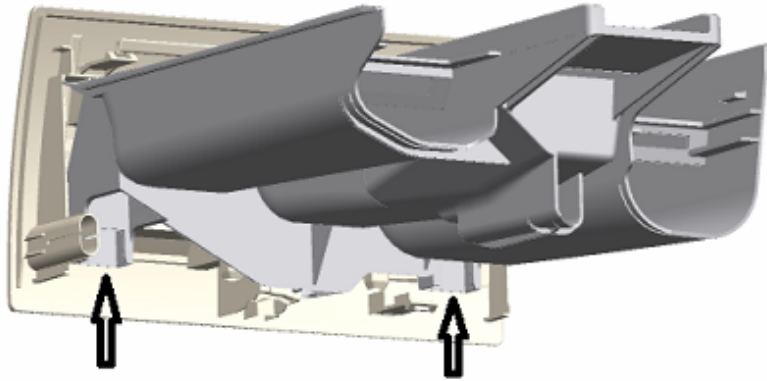

2. Rimuovere la maniglia del cassetto del detersivo.

4.4.2 Montaggio della maniglia del cassetto del detersivo

- ▶ Per il montaggio, seguire la procedura sopra descritta in senso opposto.

4.5 Sostituzione dell'oblò



ATTENZIONE

Zona della cerniera aperta!

Rischio di schiacciamento delle dita / di rimanere incastrati

- ▶ Non inserire le dita nella zona della cerniera.
- ▶ Indossare guanti di protezione.

Prerequisiti:

- ✔ L'apparecchio è scollegato dalla rete elettrica.
- ✔ L'apparecchio è scollegato dalla rete idrica.
- ✔ L'oblò è aperto.

4.5.1 Smontaggio dell'oblò

1.



ATTENZIONE!

Rischio di caduta di componenti a causa di viti allentate!

Danni a altre parti dell'apparecchio o all'abitazione del cliente, ad es. parte inferiore.

- ▶ Fissare i componenti in modo che non cadano.



ATTENZIONE

Rischio di caduta di componenti a causa di viti allentate!

Lesioni provocate dalla caduta di componenti.

- ▶ Fissare i componenti in modo che non cadano.

Rimuovere le viti (1).

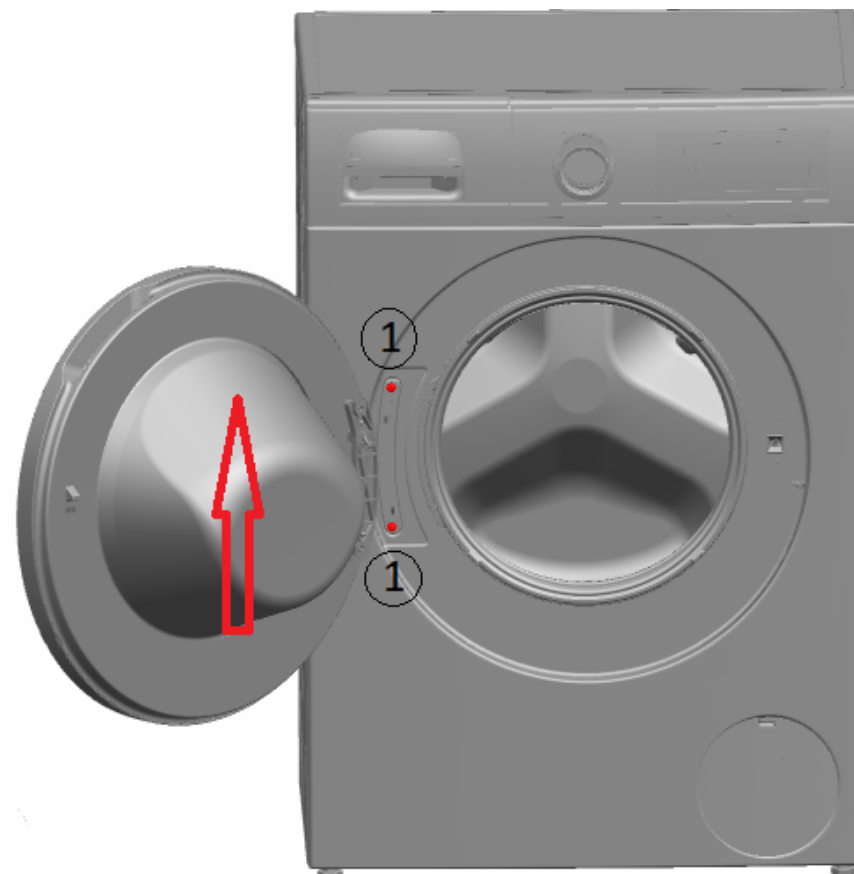

2. Smontare l'oblò sollevandolo.

4.5.2 Montaggio dell'oblò

- ▶ Per il montaggio, seguire la procedura sopra descritta in senso opposto.

4.6 Sostituzione dei componenti dell'oblò



ATTENZIONE

Zona della cerniera aperta!

Rischio di schiacciamento delle dita / di rimanere incastrati

- ▶ Non inserire le dita nella zona della cerniera.
- ▶ Indossare guanti di protezione.

Prerequisiti:

- ✓ L'apparecchio è scollegato dalla rete elettrica.
- ✓ L'apparecchio è scollegato dalla rete idrica.
- ✓ [L'oblò è stato smontato. → 275](#)

4.6.1 Smontaggio dei componenti dell'oblò

- ▶ Smontare l'oblò procedendo dall'esterno verso l'interno.

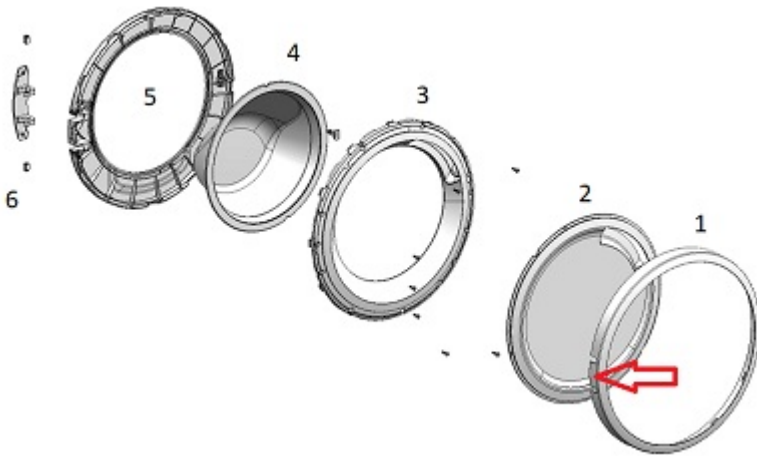

4.6.2 Montaggio dei componenti dell'oblò

- ▶ Per il montaggio, seguire la procedura sopra descritta in senso opposto.

4.7 Sostituzione della guarnizione dell'oblò



ATTENZIONE

Alloggiamento con spigoli vivi!
Ferite da taglio
▶ Indossare guanti di protezione.



ATTENZIONE

Rischio di caduta di componenti a causa di viti allentate!
Lesioni provocate dalla caduta di componenti.
▶ Fissare i componenti in modo che non cadano.



ATTENZIONE!

Rischio di caduta di componenti a causa di viti allentate!
Danni a altre parti dell'apparecchio o all'abitazione del cliente, ad es. parte inferiore.
▶ Fissare i componenti in modo che non cadano.

Prerequisiti:

- ✓ L'apparecchio è scollegato dalla rete elettrica.
- ✓ L'apparecchio è scollegato dalla rete idrica.
- ✓ [Il cassetto del detersivo è stato rimosso.→273](#)
- ✓ [L'oblò è stato smontato.→275](#)
- ✓ [La copertura della pompa è stata rimossa.→284](#)

4.7.1 Rimozione della guarnizione dell'oblò

1.



AVVERTENZA

Gli apparecchi inclinati possono scivolare!
Fratture / lesioni da schiacciamento
▶ Fissare gli apparecchi in modo che non scivolino.

Solleverare l'apparecchio per la parte frontale.

2. Allentare le viti nella parte inferiore del pannello frontale (1).

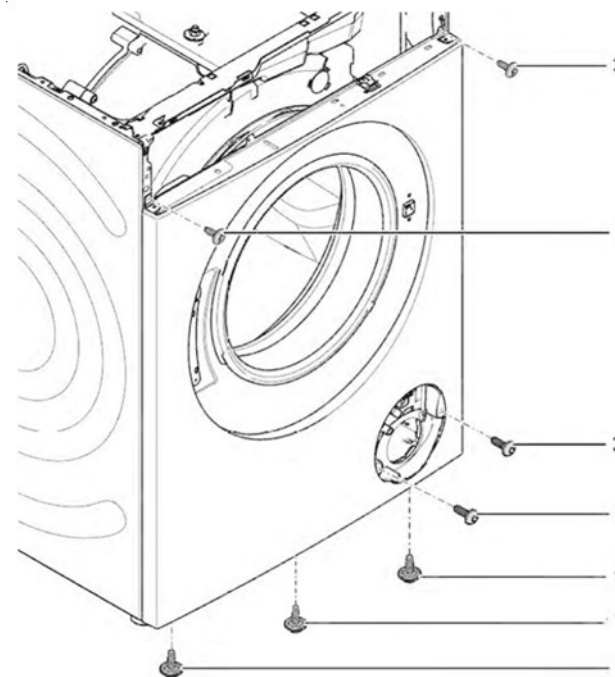

3. Abbassare l'apparecchio.

Riparazione

4. Rimuovere le viti nella zona della pompa (2).

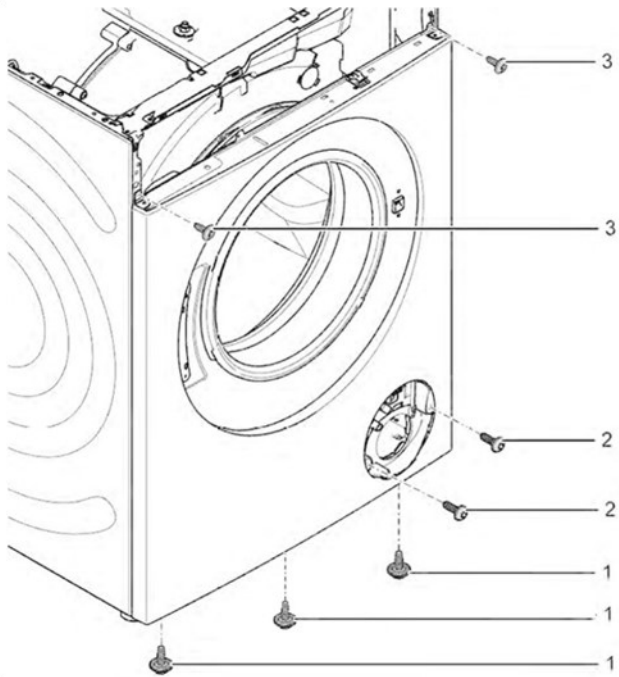

5. 1. Rimuovere le viti sul retro dell'apparecchio (1).
2. Smontare il piano di lavoro (2, 3).

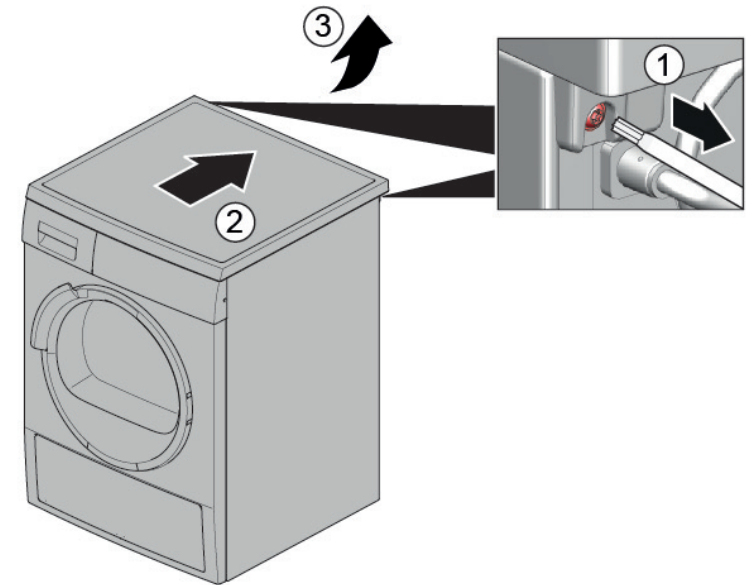

Riparazione

6. 1. Rimuovere le viti (1).
2. Sganciare gli elementi di blocco del pannello comandi (2, 3).
3. Rimuovere le viti dell'alloggiamento del distributore.

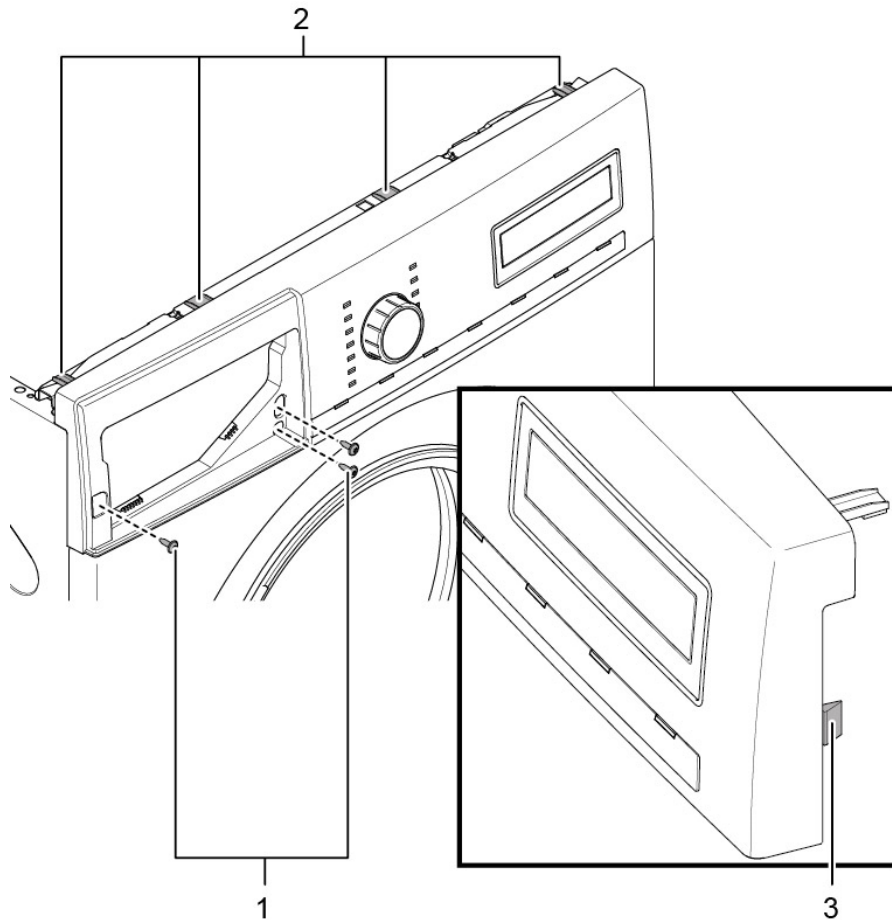

7. Smontare il pannello comandi.

8. Rimuovere il supporto della luce del cestello nella parte superiore.

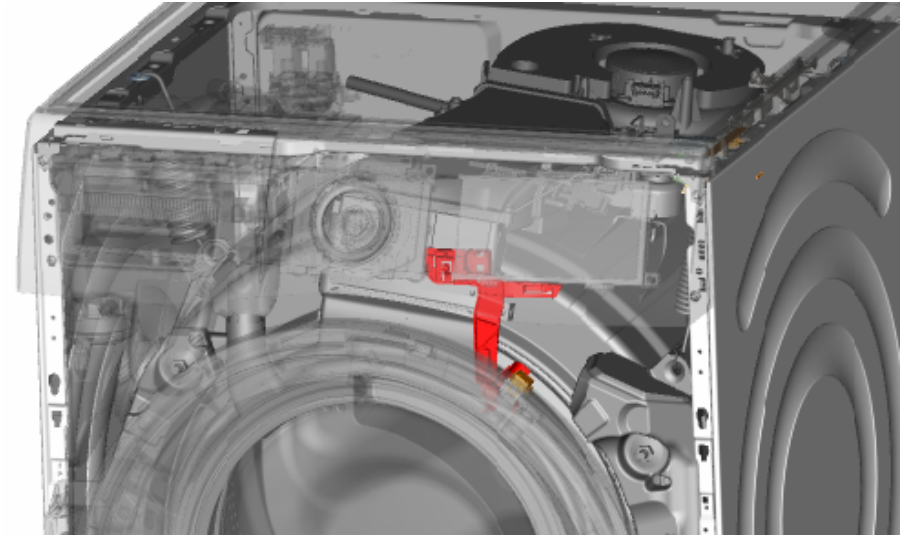

9.



ATTENZIONE!

Rischio di danneggiare la superficie!

La superficie dell'apparecchio potrebbe graffiarsi se si utilizzano attrezzi non adatti.

- Utilizzare solo attrezzi di plastica per sostituire l'anello a molla.

Rimuovere l'anello a molla dalla guarnizione con un attrezzo di plastica.

10. Smontare la guarnizione dell'oblò dal pannello frontale.
11. Allentare il connettore del cavo dalla chiusura di sicurezza.

12. Allentare le viti nella parte superiore del pannello frontale (3).

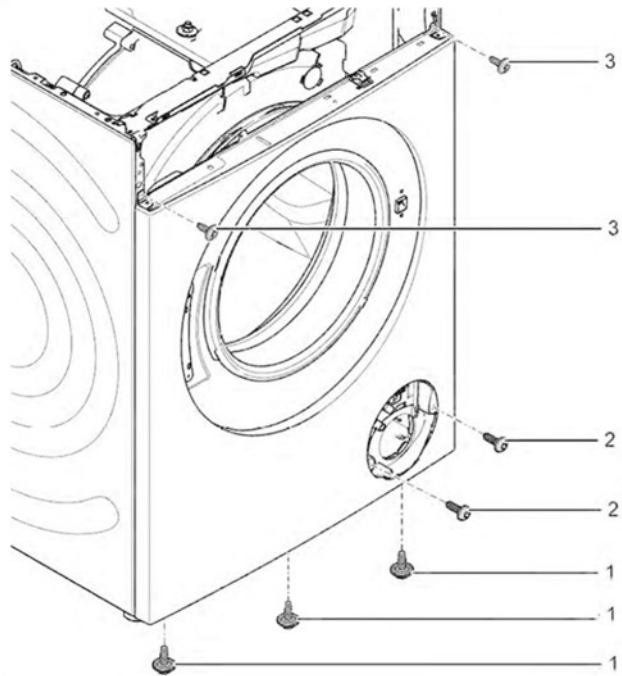

13. Rimuovere il pannello frontale.

14. Allentare la connessione di tutti i tubi flessibili.

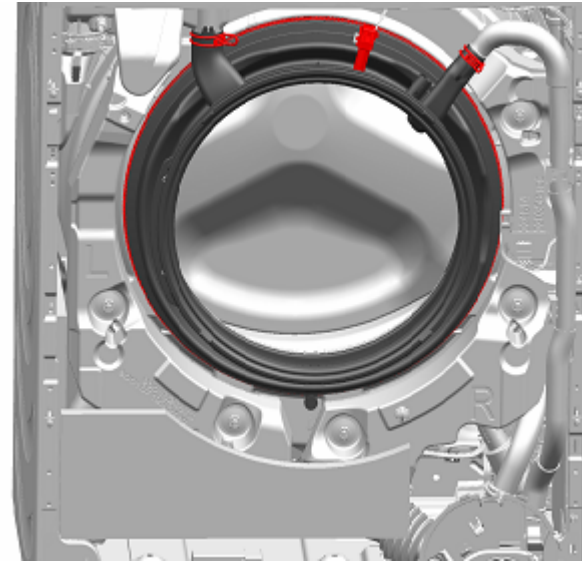

15. Rimuovere la guarnizione dell'oblò.

4.7.2 Installazione della guarnizione dell'oblò



AVVERTENZA

Rischio di caduta di componenti a causa di installazione errata!

Lesioni o danni all'apparecchio.

- ▶ Serrare l'anello di bloccaggio della guarnizione dello sportello con una coppia di 3,4 Nm.

▶ Per il montaggio, seguire la procedura sopra descritta in senso opposto.

4.8 Sostituzione del blocco porta

In qualità di società costruttrice, siamo tenuti a fornire ai consumatori una chiusura di sicurezza di ricambio incluse le istruzioni di riparazione in conformità al Regolamento (UE) 2019/2023. Tuttavia, desideriamo puntualizzare che, in seguito alla sostituzione della chiusura di sicurezza, un elettricista qualificato dovrà eseguire un test di sicurezza elettrotecnica prima di mettere in funzione l'apparecchio. La qualifica di tale incaricato deve essere verificata in conformità alle leggi, alle normative e alle disposizioni specifiche del Paese.

	PERICOLO
	<p>Rischio di scosse elettriche dovute a componenti sotto tensione! Pericolo di morte dovuto a scosse elettriche in caso di riparazione non conforme</p> <ul style="list-style-type: none"> ▶ Le parti elettriche devono essere riparate da elettricisti qualificati. ▶ Ultimata la riparazione, occorre eseguire un test di sicurezza conforme alla norma VDE 0701 o alle norme specifiche del Paese.

	ATTENZIONE
	<p>Alloggiamento con spigoli vivi! Ferite da taglio</p> <ul style="list-style-type: none"> ▶ Indossare guanti di protezione.

	AVVERTENZA
	<p>Gli apparecchi inclinati possono scivolare! Fratture / lesioni da schiacciamento</p> <ul style="list-style-type: none"> ▶ Fissare gli apparecchi in modo che non scivolino.

	ATTENZIONE
	<p>Rischio di caduta di componenti a causa di viti allentate! Lesioni provocate dalla caduta di componenti.</p> <ul style="list-style-type: none"> ▶ Fissare i componenti in modo che non cadano.

	ATTENZIONE!
	<p>Rischio di caduta di componenti a causa di viti allentate! Danni a altre parti dell'apparecchio o all'abitazione del cliente, ad es. parte inferiore.</p> <ul style="list-style-type: none"> ▶ Fissare i componenti in modo che non cadano.

Prerequisiti:

- ✓ L'apparecchio è scollegato dalla rete elettrica.
- ✓ L'apparecchio è scollegato dalla rete idrica.
- ✓ L'apparecchio è liberamente accessibile.
- ✓ [Il piano di lavoro è stato smontato. →271](#)
- ✓ Il pannello comandi è stato smontato.
- ✓ [L'oblò è stato smontato. →275](#)
- ✓ L'anello a molla è stato smontato.
- ✓ Il pannello frontale è stato smontato.
- ✓ La guarnizione dell'oblò è stata smontata.

4.8.1 Smontaggio del blocco porta

1. Scollegare la spina del blocco porta.
2. Smontare il blocco porta.



3. Rimuovere il blocco porta.

4.8.2 Montaggio del blocco porta

Il blocco porta deve trovarsi in posizione corretta per garantire l'apertura di emergenza dell'oblò dell'apparecchio.



- ▶ Per il montaggio, seguire la procedura sopra descritta in senso opposto.

4.9 Sostituzione della luce del cestello



ATTENZIONE

Alloggiamento con spigoli vivi!
Ferite da taglio
▶ Indossare guanti di protezione.



AVVERTENZA

Gli apparecchi inclinati possono scivolare!
Fratture / lesioni da schiacciamento
▶ Fissare gli apparecchi in modo che non scivolino.



ATTENZIONE

Rischio di caduta di componenti a causa di viti allentate!
Lesioni provocate dalla caduta di componenti.
▶ Fissare i componenti in modo che non cadano.



ATTENZIONE!

Rischio di caduta di componenti a causa di viti allentate!
Danni a altre parti dell'apparecchio o all'abitazione del cliente, ad es. parte inferiore.
▶ Fissare i componenti in modo che non cadano.

Prerequisiti:

- ✔ L'apparecchio è scollegato dalla rete elettrica.
- ✔ L'apparecchio è scollegato dalla rete idrica.
- ✔ L'apparecchio è liberamente accessibile.
- ✔ [Il piano di lavoro è stato smontato.→271](#)
- ✔ [Il cassetto del detersivo è stato rimosso.→273](#)
- ✔ Il pannello comandi è stato smontato.

4.9.1 Smontaggio della luce del cestello

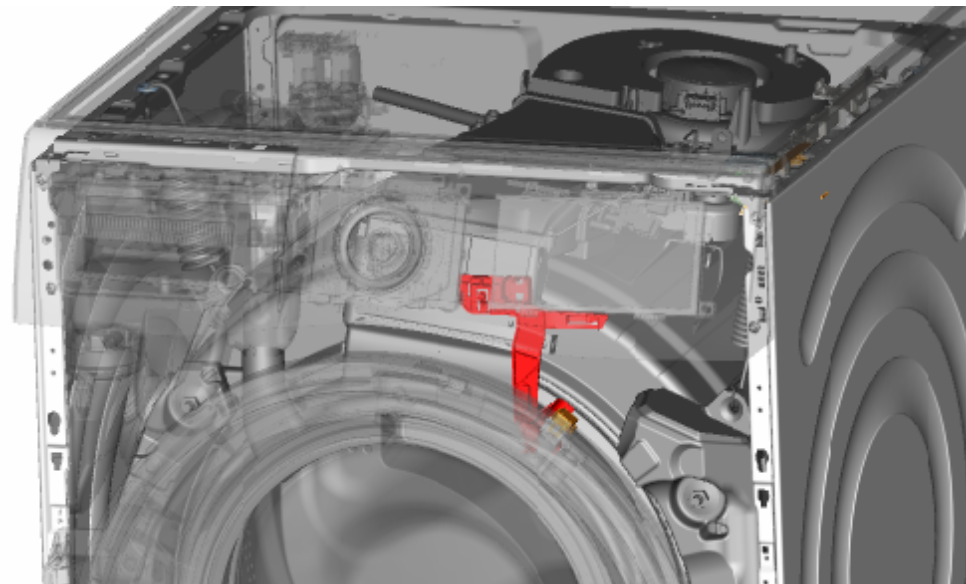

1. Estrarre dall'apparecchio il supporto della luce del cestello.
2. Staccare i collegamenti elettrici.
3. Rimuovere la luce del cestello dal suo supporto.

4.9.2 Montaggio della luce del cestello

- ▶ Per il montaggio, seguire la procedura sopra descritta in senso opposto.

4.10 Sostituzione della copertura della pompa

Prerequisiti:

- ✓ L'apparecchio è scollegato dalla rete elettrica.
- ✓ L'apparecchio è scollegato dalla rete idrica.

4.10.1 Smontaggio della copertura della pompa

1. Aprire la copertura della pompa.

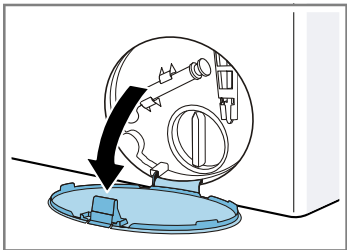

2. Togliere la copertura della pompa.

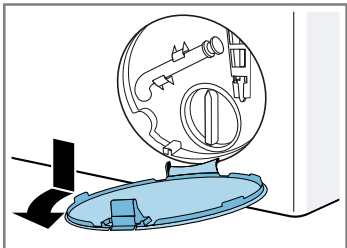

4.10.2 Montaggio della copertura della pompa

- ▶ Per il montaggio, seguire la procedura sopra descritta in senso opposto.

4.11 Sostituzione del pannello frontale



ATTENZIONE

Alloggiamento con spigoli vivi!
Ferite da taglio
▶ Indossare guanti di protezione.

Prerequisiti:

- ✓ L'apparecchio è scollegato dalla rete elettrica.
- ✓ L'apparecchio è scollegato dalla rete idrica.
- ✓ [Il cassetto del detersivo è stato rimosso.→273](#)
- ✓ [L'oblò è stato smontato.→275](#)
- ✓ La guarnizione dell'oblò è stata smontata.
- ✓ [La copertura della pompa è stata rimossa.→284](#)

4.11.1 Smontaggio del pannello frontale

1.



AVVERTENZA

Gli apparecchi inclinati possono scivolare!
Fratture / lesioni da schiacciamento
▶ Fissare gli apparecchi in modo che non scivolino.

Sollevare l'apparecchio per la parte frontale.

2. Rimuovere le viti nella parte inferiore (1).

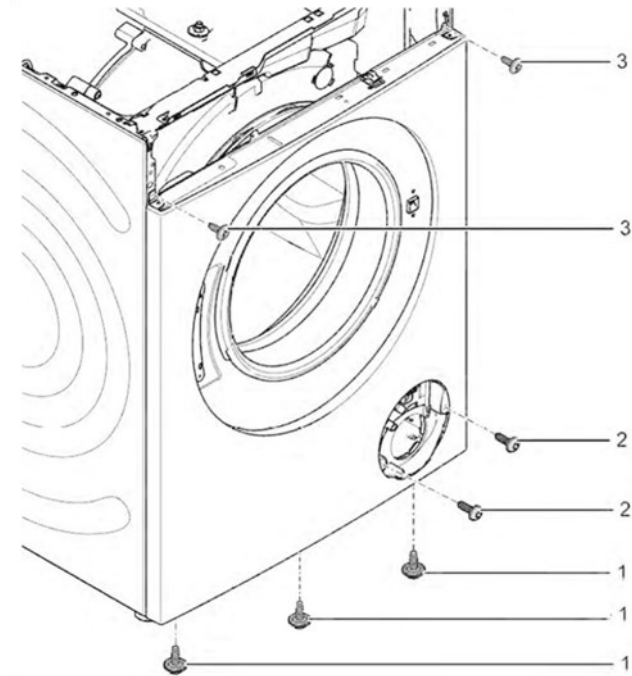

3. Abbassare l'apparecchio.

Riparazione

4. 1. Rimuovere le viti (1).
2. Far scorrere il piano di lavoro verso la parte posteriore dell'apparecchio (2).
3. Smontare il piano di lavoro tirandolo verso l'alto (3).

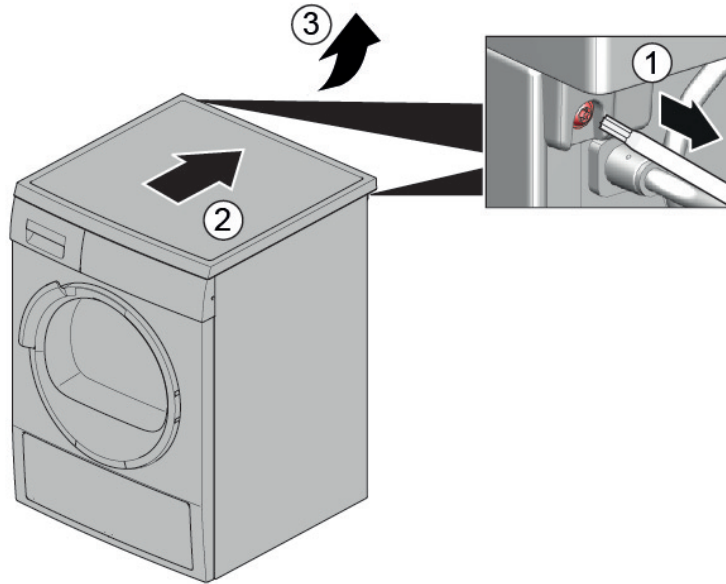

5. 1. Rimuovere le viti (1).
2. Sganciare gli elementi di blocco (2, 3).

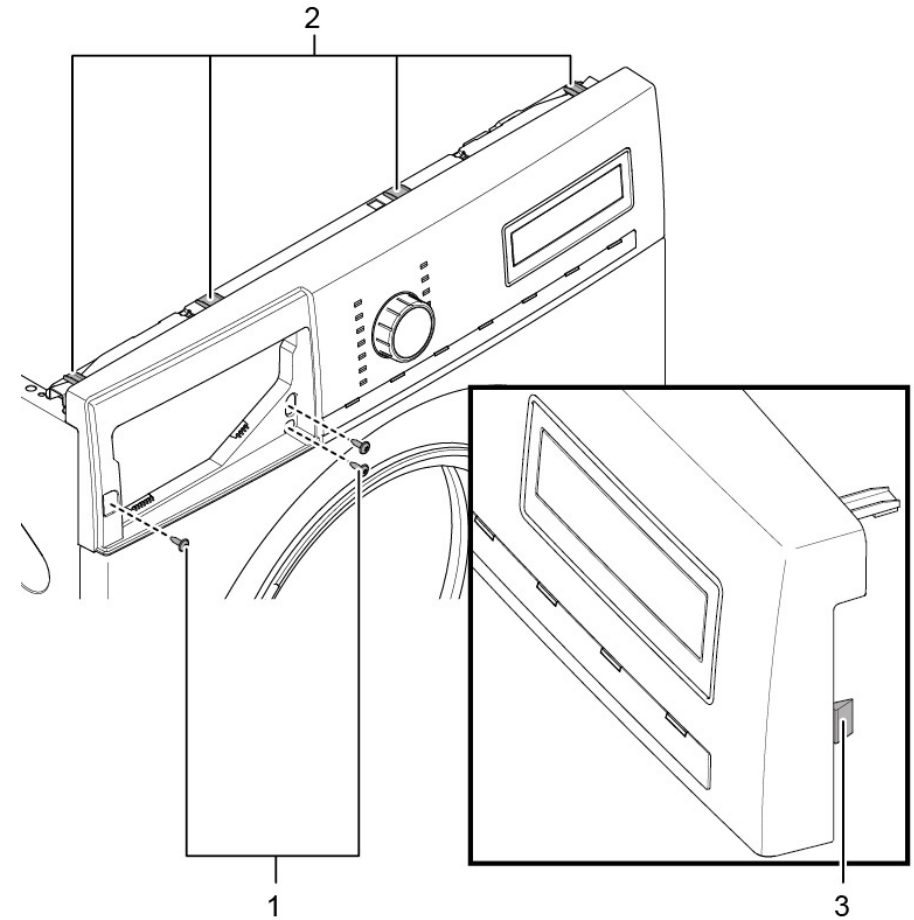

6. Smontare il pannello comandi.

7.



ATTENZIONE

Rischio di caduta di componenti a causa di viti allentate!

Lesioni provocate dalla caduta di componenti.

- Fissare i componenti in modo che non cadano.



ATTENZIONE!

Rischio di caduta di componenti a causa di viti allentate!
Danni a altre parti dell'apparecchio o all'abitazione del cliente, ad es. parte inferiore.

- ▶ Fissare i componenti in modo che non cadano.

Rimuovere le viti nella parte frontale procedendo dal basso verso l'alto (2, 3).

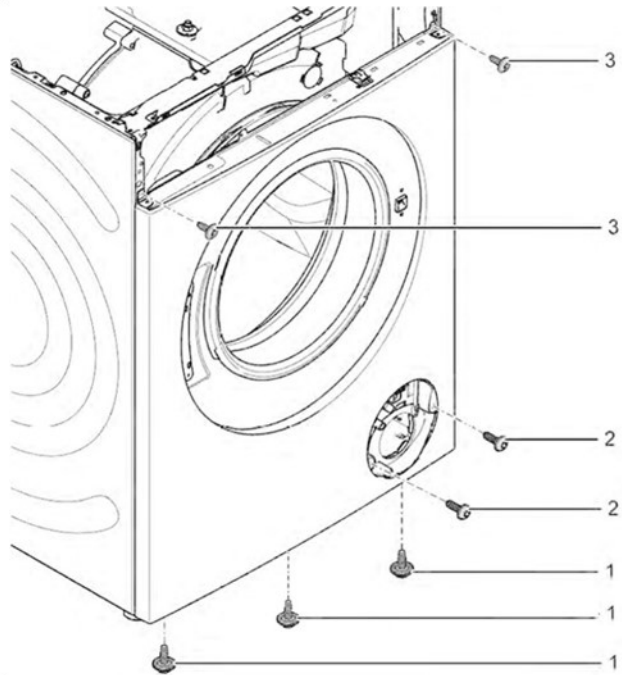





8. Rimuovere il pannello frontale.

4.11.2 Montaggio del pannello frontale

- ▶ Per il montaggio, seguire la procedura sopra descritta in senso opposto.

Informācija par remontu - Veļas mazgājamā mašīna

 Par šo dokumentu	289	4.8 Durtiņu slēga nomaiņa.....	303
1.1 Būtiska informācija	289	4.8.1 Durtiņu slēga noņemšana	303
1.1.1 Mērķis	289	4.8.2 Durtiņu slēga uzstādīšana	304
1.2 Simbolu skaidrojums.....	289	4.9 Bunduļa lampiņas nomaiņa.....	305
1.2.1 Bīstamības līmeņi	289	4.9.1 Bunduļa lampiņas izņemšana.....	305
1.2.2 Bīstamības simboli.....	289	4.9.2 Bunduļa lampiņas uzstādīšana	305
1.2.3 Brīdinājumu struktūra	290	4.10 Sūkņa vāka nomaiņa.....	306
1.2.4 Vispārīgie simboli.....	290	4.10.1 Sūkņa vāka noņemšana.....	306
 Drošība	291	4.10.2 Sūkņa vāka uzstādīšana	306
2.1 Vispārējie drošības norādījumi	291	4.11 Priekšējā paneļa nomaiņa	307
2.1.1 Visām mājsaimniecības ierīcēm	291	4.11.1 Priekšējā paneļa noņemšana	307
 Piederumi un palīgļīdzekļi	292	4.11.2 Priekšējā paneļa uzstādīšana.....	309
 Remonts	293		
4.1 Darbvirsmas nomaiņa.....	293		
4.1.1 Darbvirsmas noņemšana.....	293		
4.1.2 Darbvirsmas uzstādīšana	293		
4.2 Fascijas paneļa nomaiņa	294		
4.2.1 Fascijas paneļa noņemšana	294		
4.2.2 Fascijas paneļa uzstādīšana.....	294		
4.3 Mazgāšanas līdzekļa atvilktnes nomaiņa.....	295		
4.3.1 Mazgāšanas līdzekļa atvilktnes izņemšana.....	295		
4.3.2 Mazgāšanas līdzekļa atvilktnes uzstādīšana.....	295		
4.4 Mazgāšanas līdzekļa atvilktnes roktura nomaiņa	296		
4.4.1 Mazgāšanas līdzekļa atvilktnes roktura izņemšana	296		
4.4.2 Mazgāšanas līdzekļa atvilktnes roktura uzstādīšana	296		
4.5 Durtiņu nomaiņa	297		
4.5.1 Durtiņu noņemšana.....	297		
4.5.2 Durtiņu uzstādīšana	297		
4.6 Durtiņu detaļu nomaiņa	298		
4.6.1 Durtiņu daļu noņemšana.....	298		
4.6.2 Durtiņu daļu uzstādīšana	298		
4.7 Durtiņu blīves nomaiņa	299		
4.7.1 Durtiņu blīves noņemšana	299		
4.7.2 Durtiņu blīvējuma uzstādīšana	302		

i Par šo dokumentu

1.1 Būtiska informācija

1.1.1 Mērķis

Šie labošanas ieteikumi ir paredzēti patērētājam, lai patstāvīgi labotu ierīces, saskaņā ar piemērojamo Ekodizaina regulu (sākot no 03.2021.).



Ir sniegta informācija, kā nomainīt noteiktas rezerves daļas, un brīdinājumi, kā arī ir aprakstīti riski.

Ja ir jautājumi, sazinieties ar mūsu klientu apkalpošanas dienestu. Mēs atbildam par zaudējumiem tikai tad, ja šie labošanas ieteikumi ir pienācīgi ievēroti.

1.2 Simbolu skaidrojums

1.2.1 Bīstamības līmeņi

Brīdinājuma līmeņus veido simbols un signālvārds. Signālvārds apzīmē bīstamības pakāpi.





Brīdinājuma līmenis	Nozīme
 BĪSTAMI	Brīdinājuma paziņojuma neievērošanas rezultātā iestāsies nāve vai radīsies smagas traumas.
 BRĪDINĀJUMS	Brīdinājuma paziņojuma neievērošanas rezultātā var iestāties nāve vai rasties smagas traumas.
 ESJET PIESARDŽĪGI	Brīdinājuma paziņojuma neievērošanas rezultātā var rasties nelielas traumas.
 UZMANĪBU!	Brīdinājuma paziņojuma neievērošanas rezultātā var rasties kaitējums īpašumam.

Tabula 1: Bīstamības līmeņi



1.2.2 Bīstamības simboli

Bīstamības simboli ir simboliski apzīmējumi, kas sniedz norādes par bīstamības veidu.

Šajā dokumentā ir izmantoti šādi bīstamības simboli:

Bīstamības simbols	Nozīme
	Vispārējs brīdinājuma paziņojums
	Elektriskā sprieguma radīts apdraudējums
	Sprādzienbīstamības risks
	Griezumu bīstamība
	Saspiešanas bīstamība

i Par šo dokumentu

Bīstamības simbols	Nozīme
	Karstu virsmu radīta bīstamība
	Spēcīgu magnētisko lauku radīta bīstamība
	Nejonizējoša starojuma radīta bīstamība

Tabula 2: Bīstamības simboli

1.2.3 Brīdinājumu struktūra

Šajā dokumentā sniegtajiem brīdinājumiem ir standartizēts noformējums un standartizēta struktūra.



	<p>⚠ BĪSTAMI</p> <p>Bīstamības veids un avots! Iespējamās sekas, kas rodas, neievērojot bīstamības paziņojumu / brīdinājumu.</p> <ul style="list-style-type: none"> ▶ Bīstamības novēršanas pasākumi un aizliegumi.
--	--





Nākamajā piemērā ir parādīts brīdinājums, kas apzīmē elektrotrieciena risku, ko rada spriegumaktīvas detaļas. Ir norādīts bīstamības novēršanas pasākums.

	<p>⚠ BĪSTAMI</p> <p>Elektrotrieciena risks, ko rada spriegumaktīvas detaļas! Nāvējošs elektrotrieciens</p> <ul style="list-style-type: none"> ▶ Atvienojiet iekārtas no strāvas padeves vismaz 60 sekundes pirms labošanas sākšanas.
--	---

1.2.4 Vispārīgie simboli

Šajā dokumentā ir izmantoti šādi vispārīgie simboli:

Visp. simbols	Nozīme
	Īpašu ieteikumu apzīmējums (teksts un/ vai grafika)
	Vienkāršu ieteikumu apzīmējums (tikai teksts)

Visp. simbols	Nozīme
	Video pamācības saites apzīmējums
	Nepieciešamo rīku apzīmējums
	Nepieciešamo priekšnosacījumu apzīmējums
	Nosacījuma apzīmējums (ja ..., tad ...)
	Rezultāta apzīmējums
[Sākt]	Taustiņa vai pogas apzīmējums
[00123456]	Materiāla numura apzīmējums
Statuss	Attēlotā teksta / loga apzīmējums (iekārtas displejā)

Tabula 3: Vispārīgie simboli

2.1 Vispārējie drošības norādījumi

2.1.1 Visām mājsaimniecības ierīcēm

Elektrotrieciena risks spriegumaktīvu daļu dēļ!

- Ja remonts, kas skar elektriskās daļas, ir veikts kļūdaini, pastāv elektrotrieciena risks!
- Ierīcei ir jābūt atvienotai no tīkla vismaz 60 sekundes, pirms sāk darbu.
- Pēc remonta ierīces drošība ir jāpārbauda atbilstīgi noteikumiem VDE 0701 vai valsts noteikumiem.

Savainojumu risks asu malu dēļ!

- Valkājiet aizsargcimdus.

Saspiešanas risks labošanas, uzturēšanas, traucējumu novēršanas un apkopes laikā, ko rada smagas un kustīgas detaļas

- Valkājiet aizsargapavus.
- Nostipriniet smagas detaļas, lai tās nenokristu.
- Neievietojiet ķermeņa daļas kustīgās detaļās.







Ierīces drošības / darbības traucējuma risks!





- Izmantojiet tikai oriģinālās rezerves daļas.

Pret elektrostatisko izlādi jutīgu daļu (ESDS) bojājuma risks!

- Neaiztieciet moduļus, ieskaitot savienojumus un vadojumu.

Piederumi un palīglīdzekļi

Apzīmējums	Sīkāka informācija	Attēli
Papildu instruments [15000155]	Instrumenti plastmasas detaļu atvienošanai	
Skrūvgriezis Torx T20 ar urbumu [00340764]	100 mm, skrūvēm ar drošības tapiņu	
Momentatslēga [15000441]	Momentatslēga: 20–100 Nm	
Plakans skrūvgriezis [00340854]	Izmērs: 3,5 mm x 0,6 mm x 100 mm, aizsargizolācija: 1000 V maiņstrāva	
Plakans skrūvgriezis [00340855]	Izmērs: 5,5 mm x 1,0 mm x 125 mm, aizsargizolācija: 1000 V maiņstrāva	
Asknaibles, izliektas [00341269]	Garums: 200 mm	
Sānknaibles [00342182]	Garums: 200 mm	



Apzīmējums	Sīkāka informācija	Attēli
Kombinētā uzgriežņu atslēga [00340811]	Atslēgas platums 10°mm, M6	
Combination wrench [00340814]	Atslēgas platums 13°mm, M8	
Kombinētā uzgriežņu atslēga [00340817]	Atslēgas platums 17 mm, M10	
Kombinētā uzgriežņu atslēga [15000459]	Atslēgas platums 16°mm, M10	

4.1 Darbvirsmas nomaiņa

Speciāli rīki:

-  Torx Bit TX20 ar caurumu, 6,3°mm (1/4") 152°mm, skrūvēm ar drošības tapiņu [00341272] garš

Prasība:

-  Ierīcei ir jābūt atvienotai no strāvas padeves.
-  Ierīcei ir jābūt atvienotai no ūdens padeves.

4.1.1 Darbvirsmas noņemšana

- ▶ 1. Izskrūvējiet skrūves (1).
- ▶ 2. Pastumiet darbvirsmu uz ierīces aizmuguri (2).
- ▶ 3. Virziet darbvirsmu augšup (3), lai to noņemtu.

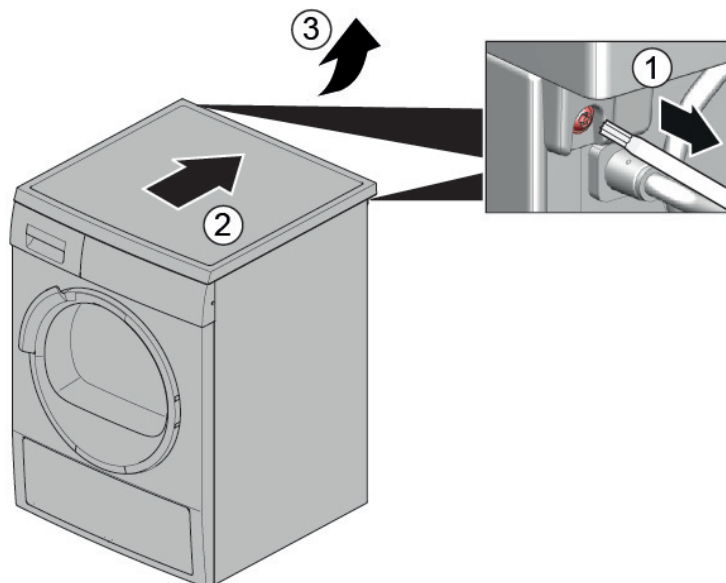

4.1.2 Darbvirsmas uzstādīšana

- ▶ Uzstādiet apgrieztā kārtībā.

4.2 Fascijas paneļa nomaiņa



⚠ ESIET PIESARDZĪGI

Asas korpusa malas!
Griezumu traumas
▶ Valkājiet aizsargcimdus.



⚠ BRĪDINĀJUMS

Sasvērušos ierīču paslīdēšana!
Kaulu lūzumi / saspiešanas traumas
▶ Nostipriniet ierīces, lai tās neslīdētu.



⚠ ESIET PIESARDZĪGI

Krītošu detaļu risks, ko izraisa vaļīgās skrūves!
Krītošu detaļu izraisītas traumas.
▶ Nostipriniet detaļu, lai tā nenokristu.



UZMANĪBU!

Krītošu detaļu risks, ko izraisa vaļīgās skrūves!
Citu ierīces detaļu bojājumi vai bojājumi, kas rodas klienta mājās, piem., apakšpuse.
▶ Nostipriniet detaļu, lai tā nenokristu.

Prasība:

- ✓ Ierīcei ir jābūt atvienotai no strāvas padeves.
- ✓ Ierīcei ir jābūt atvienotai no ūdens padeves.
- ✓ [Noņemta darbvirsma.→293](#)
- ✓ [Izņemta mazgāšanas līdzekļa atvilktnē.→295](#)

4.2.1 Fascijas paneļa noņemšana

1. 1. Izskrūvējiet skrūves (1).
2. Atvienojiet stiprinājuma elementus (2, 3).

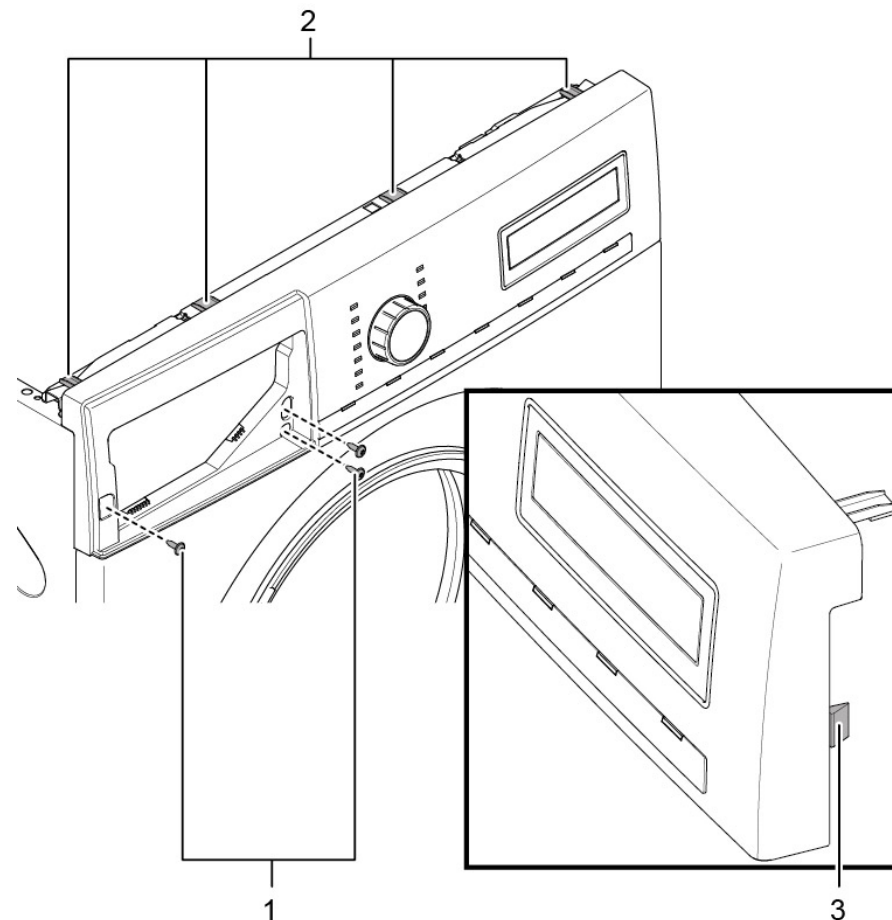

2. Atvienojiet vadības bloka spraudņa savienojumu.
3. Noņemiet fascijas paneli.

4.2.2 Fascijas paneļa uzstādīšana

- ▶ Uzstādiet apgrieztā kārtībā.

4.3 Mazgāšanas līdzekļa atvilktnes nomaiņa

Prasība:

- ✓ Ierīcei ir jābūt atvienotai no strāvas padeves.
- ✓ Ierīcei ir jābūt atvienotai no ūdens padeves.

4.3.1 Mazgāšanas līdzekļa atvilktnes izņemšana

1. Izvelciet mazgāšanas līdzekļa atvilktni.
2. 1. Nospiediet ieliktni lejup (1).
2. Izņemiet mazgāšanas līdzekļa atvilktni (2).

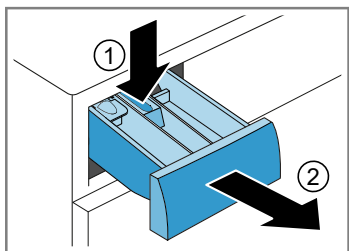

4.3.2 Mazgāšanas līdzekļa atvilktnes uzstādīšana

- ▶ Uzstādiet apgrieztā kārtībā.

4.4 Mazgāšanas līdzekļa atvilktnes roktura nomainīšana

Prasība:

- ✔ Ierīcei ir jābūt atvienotai no strāvas padeves.
- ✔ Ierīcei ir jābūt atvienotai no ūdens padeves.
- ✔ [Izņemta mazgāšanas līdzekļa atvilktnē. → 295](#)

4.4.1 Mazgāšanas līdzekļa atvilktnes roktura izņemšana

1. Atvienojiet stiprinājuma elementus.

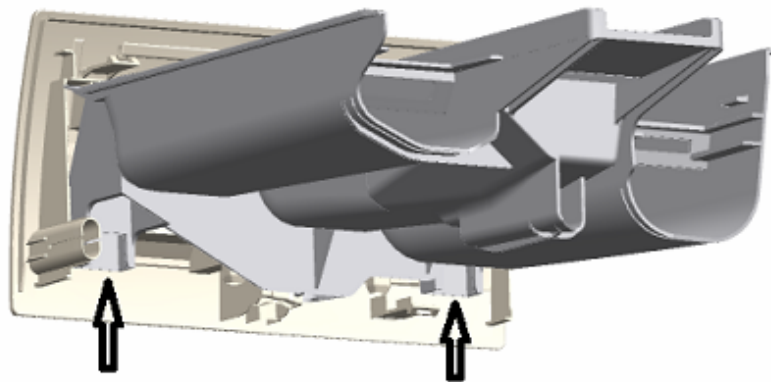

2. Noņemiet mazgāšanas līdzekļa atvilktnes rokturi.

4.4.2 Mazgāšanas līdzekļa atvilktnes roktura uzstādīšana

- ▶ Uzstādiet apgrieztā kārtībā.

4.5 Durtiņu nomaiņa



⚠ ESIET PIESARDZĪGI

Atveriet eņģu nodalījumu!

Pirkstu saspiešana / iesprūšana

- ▶ Neievietojiet rokas eņģu nodalījumā.
- ▶ Valkājiet aizsargcimdus.

Prasība:

- ✓ Ierīcei ir jābūt atvienotai no strāvas padeves.
- ✓ Ierīcei ir jābūt atvienotai no ūdens padeves.
- ✓ Atvērtas durtiņas.

4.5.1 Durtiņu noņemšana

1.



UZMANĪBU!

Krītošu detaļu risks, ko izraisa vaļīgas skrūves!

Citu ierīces detaļu bojājumi vai bojājumi, kas rodas klienta mājās, piem., apakšpuse.

- ▶ Nostipriniet detaļu, lai tā nenokristu.



⚠ ESIET PIESARDZĪGI

Krītošu detaļu risks, ko izraisa vaļīgas skrūves!

Krītošu detaļu izraisītas traumas.

- ▶ Nostipriniet detaļu, lai tā nenokristu.

Izskrūvējiet skrūves (1).

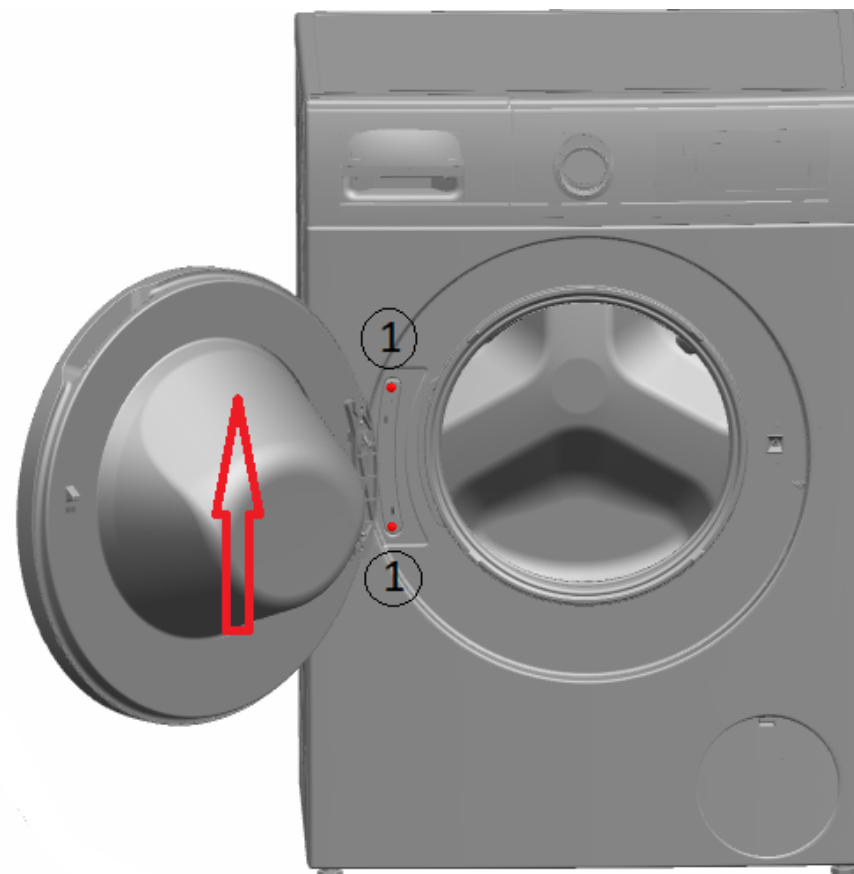

2. Virziet durtiņas augšup.

4.5.2 Durtiņu uzstādīšana

- ▶ Uzstādiet apgrieztā kārtībā.

4.6 Durtiņu detaļu nomaīņa



⚠ ESIET PIESARDZĪGI

Atveriet eņģu nodalījumu!

Pirkstu saspiešana / iesprūšana

- ▶ Neievietojiet rokas eņģu nodalījumā.
- ▶ Valkājiet aizsargcimdus.

Prasība:

- ✓ Ierīcei ir jābūt atvienotai no strāvas padeves.
- ✓ Ierīcei ir jābūt atvienotai no ūdens padeves.
- ✓ [Durtiņas ir noņemtas.→297](#)

4.6.1 Durtiņu daļu noņemšana

- ▶ Izjauciet durtiņas no ārpuses uz iekšpusi.

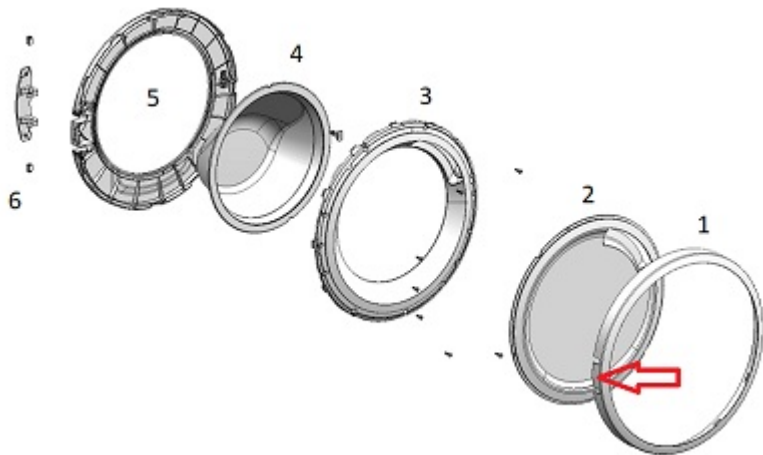

4.6.2 Durtiņu daļu uzstādīšana

- ▶ Uzstādiet apgrieztā kārtībā.

4.7 Durtiņu blīves nomaiņa



⚠ ESIET PIESARDZĪGI

Asas korpusa malas!
Griezumu traumas
▶ Valkājiet aizsargcimdus.



⚠ ESIET PIESARDZĪGI

Krītošu detaļu risks, ko izraisa vaļīgās skrūves!
Krītošu detaļu izraisītas traumas.
▶ Nostipriniet detaļu, lai tā nenokristu.



UZMANĪBU!

Krītošu detaļu risks, ko izraisa vaļīgās skrūves!
Citu ierīces detaļu bojājumi vai bojājumi, kas rodas klienta mājās, piem., apakšpuse.
▶ Nostipriniet detaļu, lai tā nenokristu.

Prasība:

- ✓ Ierīcei ir jābūt atvienotai no strāvas padeves.
- ✓ Ierīcei ir jābūt atvienotai no ūdens padeves.
- ✓ [Izņemta mazgāšanas līdzekļa atvilktnē. →295](#)
- ✓ [Durtiņas ir noņemtas. →297](#)
- ✓ [Noņemts sūkņa vāks. →306](#)

4.7.1 Durtiņu blīves noņemšana

1.



⚠ BRĪDINĀJUMS

Sasvērušos ierīču paslīdēšana!
Kaulu lūzumi / saspiešanas traumas
▶ Nostipriniet ierīces, lai tās neslīdētu.

Paceliet ierīci no priekšpusēs.

2. Atskrūvējiet priekšējā paneļa apakšā esošās skrūves (1).

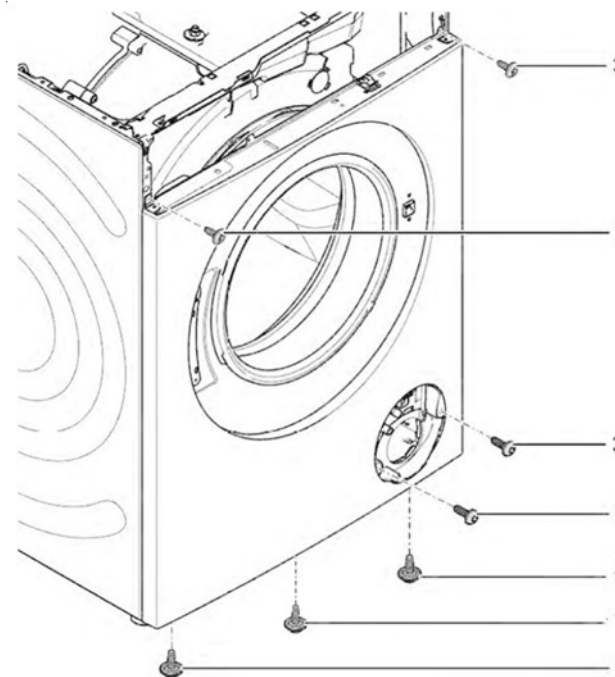

3. Pazeminiet ierīci.

4. Izskrūvējiet skrūves sūkņa zonā (2).

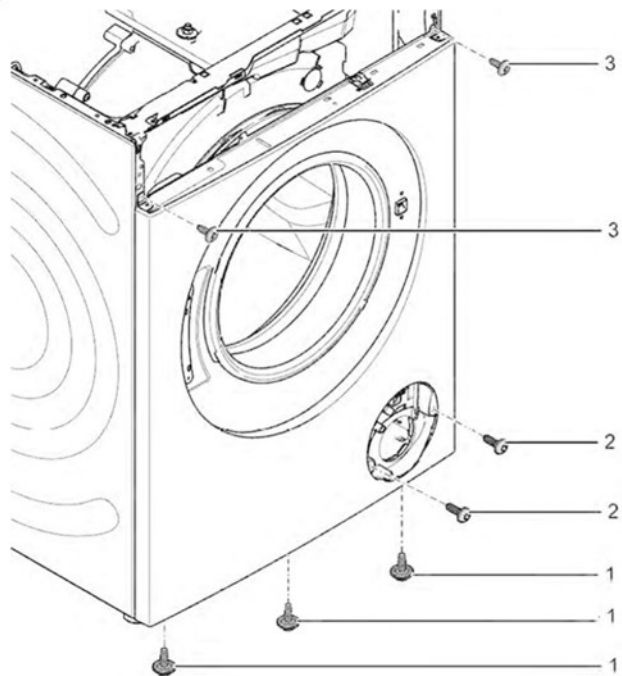

5. 1. Atskrūvējiet skrūves iekārtas aizmugurē (1).
2. Noņemiet darbvirsmu (2, 3).

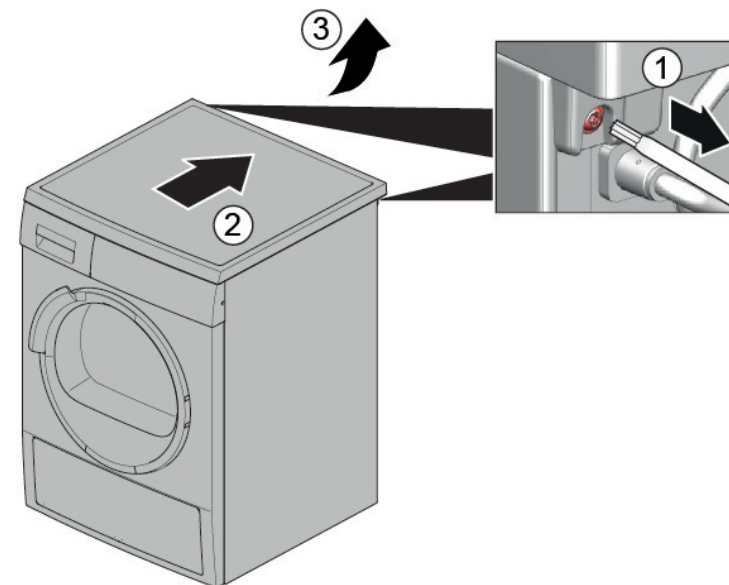

6. 1. Izskrūvējiet skrūves (1).
2. Atvienojiet fascijas paneļa stiprinājuma elementus (2, 3).
3. Atskrūvējiet dozatora korpusa skrūves.

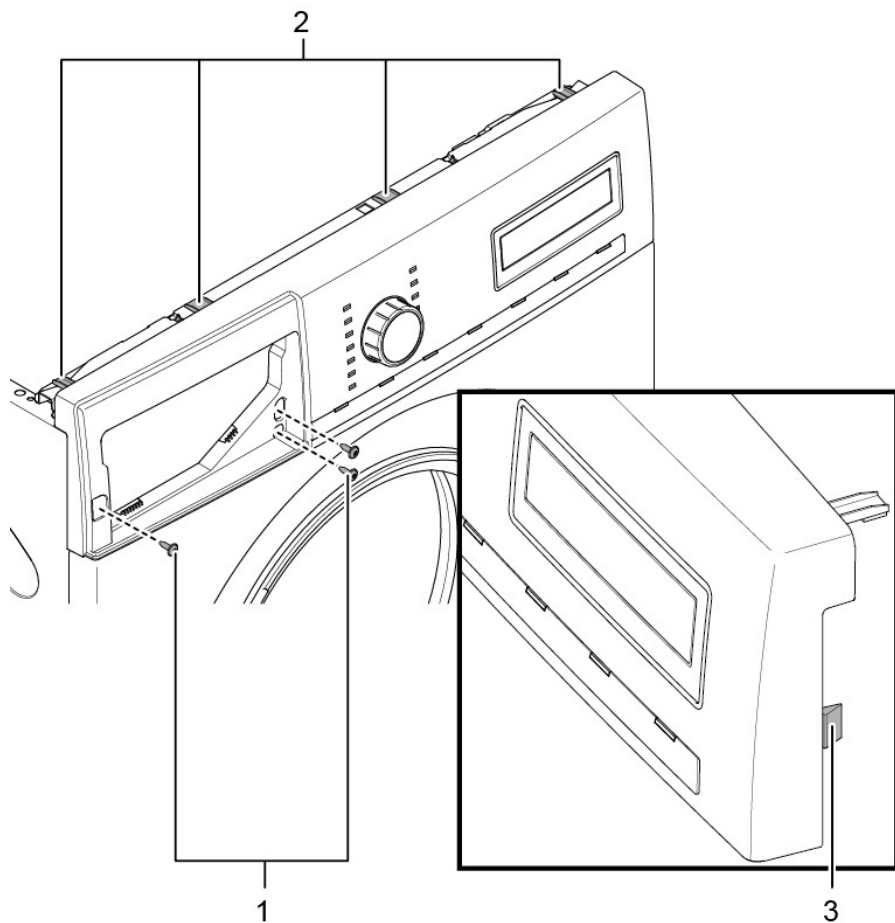

7. Noņemiet fascijas paneli.

8. Augšpusē noņemiet bunduļa lampiņas turētāju.

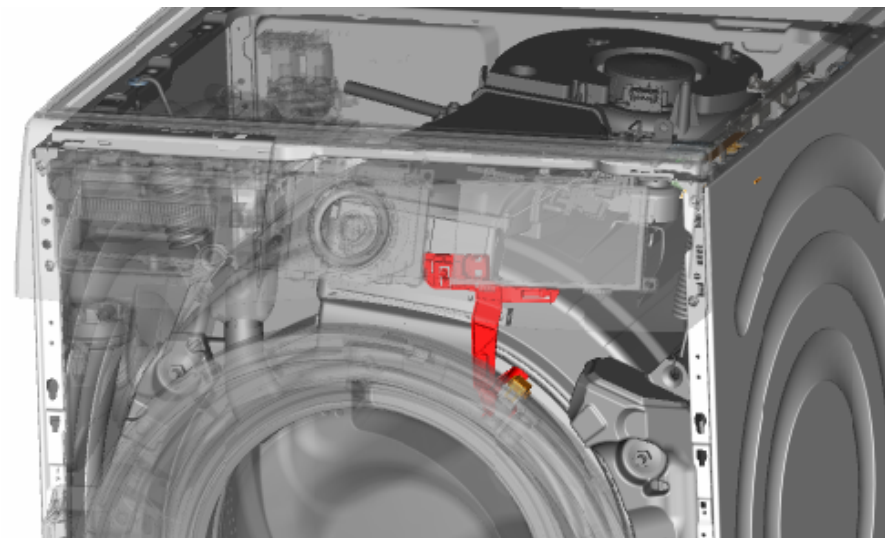

- 9.



UZMANĪBU!

Bojātu virsmu risks!

Lietojot neatbilstošus instrumentus, ierīces virsmai var rasties skrāpējumi.

- ▶ Izmantojiet tikai plastmasas instrumentus, lai nomainītu spriegotāja gredzenu.

Ar plastmasas instrumentu noņemiet spriegotāja gredzenu no blīvslēga.

10. Noņemiet durvju blīvi no priekšējā paneļa.
11. Atvienojiet vada savienotāju no durvju slēga.

12. Atskrūvējiet skrūves priekšējā paneļa augšpusē (3).

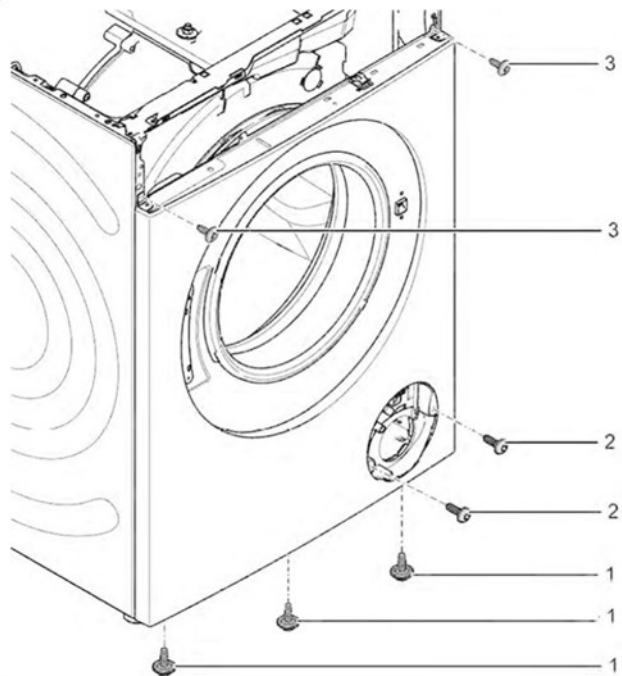

13. Noņemiet priekšējo paneli.

14. Atvienojiet visus cauruļu savienojumus.

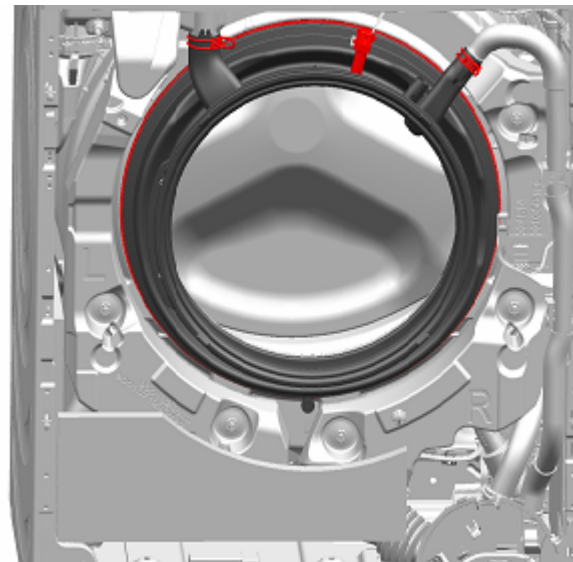

15. Noņemiet durtiņu blīvējumu.

4.7.2 Durtiņu blīvējuma uzstādīšana



BRĪDINĀJUMS

Krītošu daļu risks nepareizas uzstādīšanas dēļ!

Savainojumi vai ierīces bojājumi.

- ▶ Pievelciet tvertnes blīvslēga spriegotājgredzenu ar 3,4 Nm griezes momentu.
- ▶ Uzstādiet apgrieztā kārtībā.

4.8 Durtiņu slēga nomaiņa

Atbilstīgi Regulai (ES) 2019/2023 mums kā ražotājam ir jānodrošina patērētājiem rezerves durvju slēdzene, ieskaitot remonta instrukciju. Tomēr vēlamies norādīt, ka pēc durvju slēdzenes maiņas kvalificētam elektriķim ir jāpārbauda ierīces elektrodrošība, pirms to sāk darbināt. Elektriķim ir jāvar uzrādīt savu kvalifikāciju atbilstīgi valsts tiesību aktiem, noteikumiem un prasībām.

	BĪSTAMI Elektrotrieciena risks spriegumaktīvu daļu dēļ! Dzīvības apdraudējums nepareiza remonta izraisīta elektrotrieciena dēļ. <ul style="list-style-type: none">▶ Elektriskās daļas ir jāremontē kvalificētam elektriķim.▶ Pēc remonta ierīces drošība ir jāpārbauda atbilstīgi noteikumiem VDE 0701 vai valsts noteikumiem.
	ESIET PIESARDŽĪGI Asas korpusa malas! Griezumu traumas <ul style="list-style-type: none">▶ Valkājiet aizsargcimdus.
	BRĪDINĀJUMS Sasvērušos ierīču paslīdēšana! Kaulu lūzumi / saspiešanas traumas <ul style="list-style-type: none">▶ Nostipriniet ierīces, lai tās neslīdētu.
	ESIET PIESARDŽĪGI Krītošu detaļu risks, ko izraisa vaļīgas skrūves! Krītošu detaļu izraisītas traumas. <ul style="list-style-type: none">▶ Nostipriniet detaļu, lai tā nenokristu.
	UZMANĪBU! Krītošu detaļu risks, ko izraisa vaļīgas skrūves! Citu ierīces detaļu bojājumi vai bojājumi, kas rodas klienta mājās, piem., apakšpuse. <ul style="list-style-type: none">▶ Nostipriniet detaļu, lai tā nenokristu.

Prasība:

- ✓ Ierīcei ir jābūt atvienotai no strāvas padeves.
- ✓ Ierīcei ir jābūt atvienotai no ūdens padeves.

- ✓ Ierīcei var netraucēti piekļūt.
- ✓ [Noņemta darbvirsma. → 293](#)
- ✓ Fascijas panelis ir noņemts.
- ✓ [Durtiņas ir noņemtas. → 297](#)
- ✓ Spriegotāja gredzens ir noņemts.
- ✓ Priekšējais panelis ir noņemts.
- ✓ Durtiņu blīvējums ir noņemts.

4.8.1 Durtiņu slēga noņemšana

1. Atvienojiet durtiņu slēga spraudni.
2. Atbrīvojiet durtiņu slēgu.



3. Noņemiet durtiņu slēgu.

4.8.2 Durtiņu slēga uzstādīšana

Durtiņu slēgam ir jāatrodas pareizajā pozīcijā, lai nodrošinātu, ka iespējama ierīces durtiņu atvēršana ārkārtas situācijā.



- ▶ Uzstādiet apgrieztā kārtībā.

4.9 Bunduļa lampiņas nomaiņa



⚠ ESIET PIESARDZĪGI

Asas korpusa malas!
Griezumu traumas
▶ Valkājiet aizsargcimdus.



⚠ BRĪDINĀJUMS

Sasvērušos ierīču paslīdēšana!
Kaulu lūzumi / saspiešanas traumas
▶ Nostipriniet ierīces, lai tās neslīdētu.



⚠ ESIET PIESARDZĪGI

Krītošu detaļu risks, ko izraisa vaļīgās skrūves!
Krītošu detaļu izraisītas traumas.
▶ Nostipriniet detaļu, lai tā nenokristu.



UZMANĪBU!

Krītošu detaļu risks, ko izraisa vaļīgās skrūves!
Citu ierīces detaļu bojājumi vai bojājumi, kas rodas klienta mājās, piem., apakšpuse.
▶ Nostipriniet detaļu, lai tā nenokristu.

Prasība:

- ✓ Ierīcei ir jābūt atvienotai no strāvas padeves.
- ✓ Ierīcei ir jābūt atvienotai no ūdens padeves.
- ✓ Ierīcei var netraucēti piekļūt.
- ✓ [Noņemta darbvirsma.→293](#)
- ✓ [Izņemta mazgāšanas līdzekļa atvilkne.→295](#)
- ✓ Fascijas panelis ir noņemts.

4.9.1 Bunduļa lampiņas izņemšana

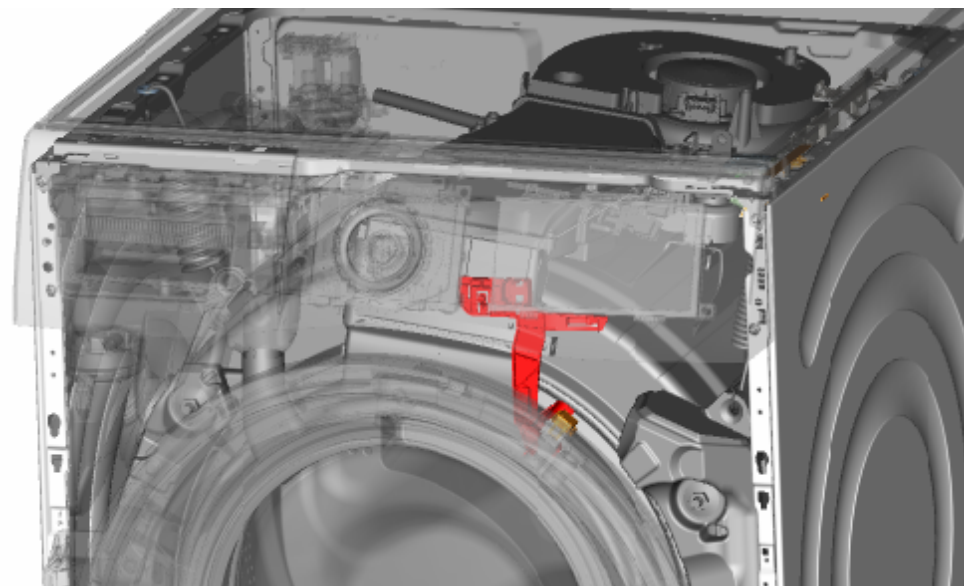

1. Izvelciet bunduļa lampiņas turētāju no ierīces.
2. Atvienojiet elektrosavienojumus.
3. Izņemiet bunduļa lampiņu no bunduļa lampiņas turētāja.

4.9.2 Bunduļa lampiņas uzstādīšana

- ▶ Uzstādiet apgrieztā kārtībā.

4.10 Sūkņa vāka nomaiņa

Prasība:

- ✓ Ierīcei ir jābūt atvienotai no strāvas padeves.
- ✓ Ierīcei ir jābūt atvienotai no ūdens padeves.

4.10.1 Sūkņa vāka noņemšana

1. Atveriet sūkņa vāku.

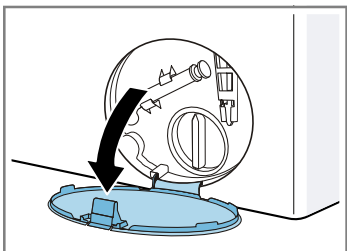

2. Noņemiet sūkņa vāku.

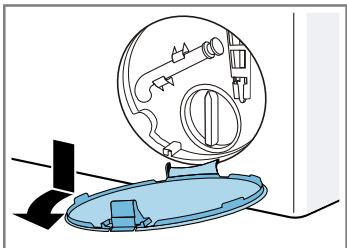

4.10.2 Sūkņa vāka uzstādīšana

- ▶ Uzstādiet apgrieztā kārtībā.

4.11 Priekšējā paneļa nomaīņa



⚠ ESIET PIESARDZĪGI

Asas korpusa malas!

- Griezumu traumas
▶ Valkājiet aizsargcimdus.

Prasība:

- ✓ Ierīcei ir jābūt atvienotai no strāvas padeves.
- ✓ Ierīcei ir jābūt atvienotai no ūdens padeves.
- ✓ [Izņemta mazgāšanas līdzekļa atvilktnē. →295](#)
- ✓ [Durtiņas ir noņemtas. →297](#)
- ✓ Durtiņu blīvējums ir noņemts.
- ✓ [Noņemts sūkņa vāks. →306](#)

4.11.1 Priekšējā paneļa noņemšana

1.



⚠ BRĪDINĀJUMS

Sasvērušos ierīču paslīdēšana!

- Kaulu lūzumi / saspiešanas traumas
▶ Nostipriniet ierīces, lai tās neslīdētu.

Paceliet ierīci no priekšpusēs.

2. Izskrūvējiet skrūves apakšpusē (1).

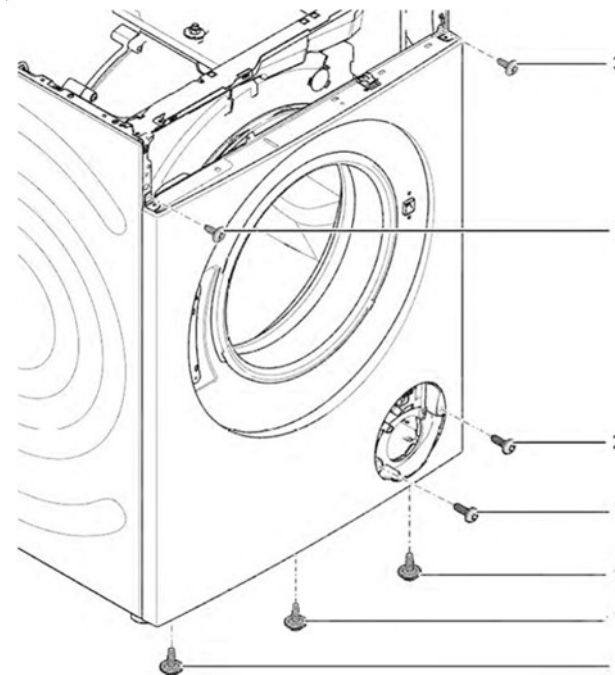

3. Pazeminiet ierīci.

Remonts

4. 1. Izskrūvējiet skrūves (1).
2. Pastumiet darbvirsmu uz ierīces aizmuguri (2).
3. Virziet darbvirsmu augšup (3), lai to noņemtu.

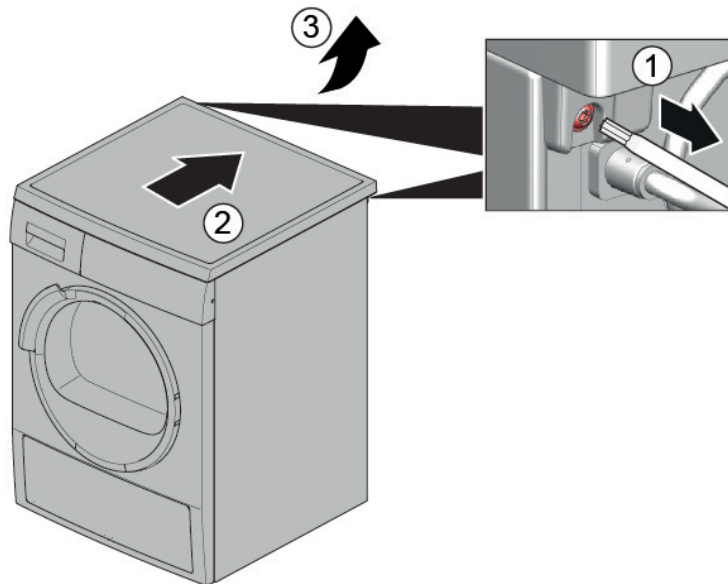

5. 1. Izskrūvējiet skrūves (1).
2. Atvienojiet stiprinājuma elementus (2, 3).

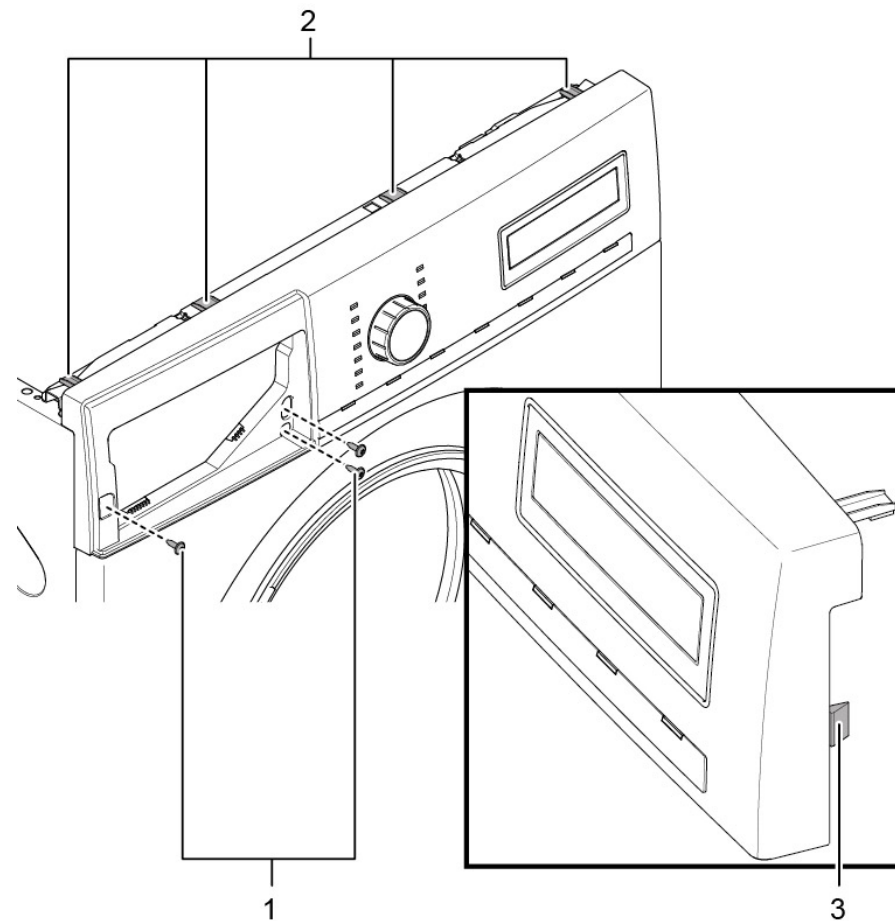

6. Noņemiet fascijas paneli.

7.



⚠ ESĪET PIESARDZĪGI

Krītošu detaļu risks, ko izraisa vaļīgas skrūves!

Krītošu detaļu izraisītas traumas.

- Nostipriniet detaļu, lai tā nenokristu.



UZMANĪBU!

Krītošu detaļu risks, ko izraisa vaļīgas skrūves!

Citu ierīces detaļu bojājumi vai bojājumi, kas rodas klienta mājās, piem., apakšpusē.

- ▶ Nostipriniet detaļu, lai tā nenokristu.

Izskrūvējiet skrūves priekšpusē no apakšas uz augšu (2, 3).

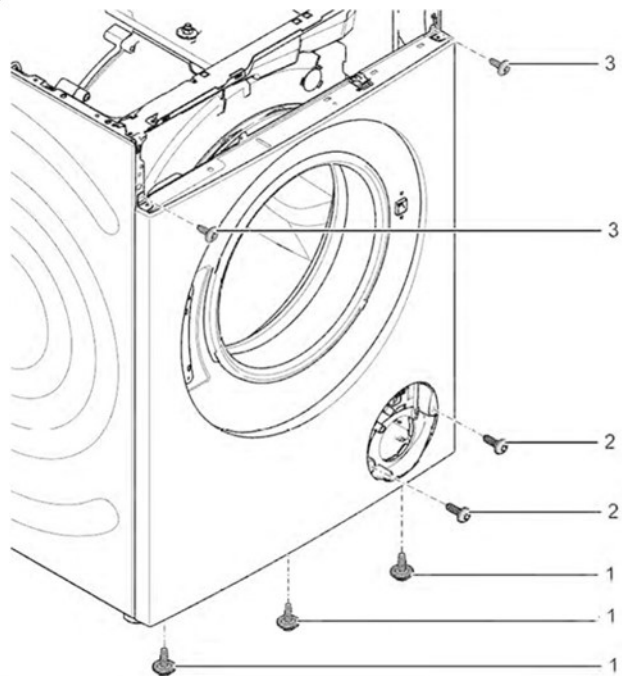



8. Noņemiet priekšējo paneli.

4.11.2 Priekšējā paneļa uzstādīšana

- ▶ Uzstādiet apgrieztā kārtībā.

Informacija apie remontą - Skalbyklė

 Dėl šio dokumento	311
1.1 Svarbi informacija	311
1.1.1 Paskirtis	311
1.2 Simbolių paaiškinimas	311
1.2.1 Pavojaus lygiai	311
1.2.2 Pavojaus simboliai	311
1.2.3 Įspėjimų struktūra	312
1.2.4 Bendrieji simboliai	312
 Sauga	313
2.1 Bendrosios saugos instrukcijos.....	313
2.1.1 Visi buitiniai prietaisai	313
 Įrankiai ir pagalbinės priemonės	314
 Remontas	315
4.1 Stalviršio keitimas	315
4.1.1 Stalviršio nuėmimas	315
4.1.2 Stalviršio uždėjimas	315
4.2 Antjuostės keitimas.....	316
4.2.1 Antjuostės nuėmimas	316
4.2.2 Antjuostės uždėjimas	316
4.3 Skalbiklio stalčiaus keitimas	317
4.3.1 Skalbiklio stalčiaus išėmimas	317
4.3.2 Skalbiklio stalčiaus įdėjimas.....	317
4.4 Skalbiklio stalčiaus dangtelio keitimas.....	318
4.4.1 Skalbiklio stalčiaus dangtelio nuėmimas	318
4.4.2 Skalbiklio stalčiaus dangtelio uždėjimas	318
4.5 Durelių keitimas.....	319
4.5.1 Durelių nuėmimas	319
4.5.2 Durelių uždėjimas	319
4.6 Durelių konstrukcinių dalių keitimas	320
4.6.1 Durelių konstrukcinių dalių nuėmimas.....	320
4.6.2 Durelių konstrukcinių dalių uždėjimas	320
4.7 Durelių sandariklio keitimas.....	321
4.7.1 Durelių sandariklio nuėmimas	321
4.7.2 Durelių sandariklio uždėjimas	324

4.8 Durelių užrakto keitimas	325
4.8.1 Durelių užrakto nuėmimas.....	325
4.8.2 Durelių užrakto sumontavimas	326
4.9 Būgno apšvietimo keitimas	327
4.9.1 Būgno apšvietimo nuėmimas.....	327
4.9.2 Būgno apšvietimo sumontavimas	327
4.10 Siurblio dangtelio keitimas	328
4.10.1 Siurblio dangtelio nuėmimas	328
4.10.2 Siurblio dangtelio uždėjimas.....	328
4.11 Priekinio skydo keitimas	329
4.11.1 Priekinio skydo nuėmimas.....	329
4.11.2 Priekinio skydo uždėjimas	331

i Dėl šio dokumento

1.1 Svarbi informacija

1.1.1 Paskirtis

Šios remonto nuorodos padeda naudotojui pataisyti prietaisus patiems pagal galiojantį ekologinio projektavimo reglamentą (2021 m. kovo mėn. redakcija).



Jose pateikta informacija, kaip pakeisti tam tikras atsargines dalis, įskaitant ir įspėjimus bei riziką.

Jei kiltų klausimų, kreipkitės į mūsų klientų aptarnavimo tarnybą. Mes atsakysime už žalą tik tuo atveju, jei bus tinkamai laikomasi remonto nuorodų.

1.2 Simbolių paaiškinimas

1.2.1 Pavojaus lygiai

Įspėjimo lygiai susideda iš simbolio ir signalinio žodžio. Signalinis žodis nurodo pavojaus sunkumą.





Įspėjimo lygis	Reikšmė
 PAVOJUS	Nepaisant įspėjamojo pranešimo, ištinka mirtis arba sunkūs sužalojimai.
 ĮSPĖJIMAS	Nepaisant įspėjamojo pranešimo, gali ištikti mirtis arba sunkūs sužalojimai.
 PERSPĖJIMAS	Nepaisant įspėjamojo pranešimo, galimi nedideli sužalojimai.
DĖMESIO!	Nepaisant įspėjamojo pranešimo, gali būti sugadintas turtas.

Lentelė 1: Pavojaus lygiai



1.2.2 Pavojaus simboliai

Pavojaus simboliai yra simboliniai atvaizdai, nurodantys pavojaus rūšį.

Šiame: dokumente naudojami tokie pavojaus simboliai

Pavojaus simbolis	Reikšmė
	Bendras įspėjamasis pranešimas
	Pavojinga elektros įtampa
	Sprogimo pavojus
	Įpjovimo pavojus
	Prispaudimo pavojus

i Dėl šio dokumento

Pavojaus simbolis	Reikšmė
	Pavojus dėl karštų paviršių
	Pavojus dėl stipraus magnetinio lauko
	Pavojus dėl nejonizuojančiosios spinduliuotės

Lentelė 2: Pavojaus simboliai

1.2.3 Įspėjimų struktūra

Šiame dokumente pateikiami įspėjimai yra standartizuotos išvaizdos ir standartizuotos struktūros.



	<div style="background-color: red; color: white; padding: 2px; display: inline-block;">⚠ PAVOJUS</div> <p>Pavojaus tipas ir šaltinis! Galimos pasekmės, jei nepaisoma pavojaus / įspėjimo.</p> <ul style="list-style-type: none"> ▶ Priemonės ir draudimai pavojui išvengti.
--	---





Šiame pavyzdyje parodytas įspėjimas, įspėjantis apie elektros smūgį dėl dalių su įtampa. Paminėta priemonė, kaip išvengti pavojaus.

	<div style="background-color: red; color: white; padding: 2px; display: inline-block;">⚠ PAVOJUS</div> <p>Elektros smūgio pavojus dėl dalių, kuriose yra įtampa! Mirtis dėl elektros smūgio</p> <ul style="list-style-type: none"> ▶ Prieš pradėdami remontą, ne mažiau kaip prieš 60 sekundžių atjunkite prietaisus nuo elektros tiekimo.
---	---

1.2.4 Bendrieji simboliai

Šiame dokumente naudojami tokie bendrieji simboliai:

Bendr. simbolis	Reikšmė
	Žymi specialų patarimą (tekstas ir (arba) grafika)
	Žymi paprastą patarimą (tik tekstas)
	Žymi nuorodą į vaizdo pamoką

Bendr. simbolis	Reikšmė
	Žymi reikalingus įrankius
	Žymi reikalingas prielaidas
	Žymi sąlygą (jei ..., tai ...)
	Žymi rezultatą
<code>[Paleisti]</code>	Žymi klavišą arba ekrano mygtuką
<code>[00123456]</code>	Žymi dalies numerį
<code>Būsena</code>	Žymi rodomą tekstą / langą (prietaiso ekrane)

Lentelė 3: Bendrieji simboliai

2.1 Bendrosios saugos instrukcijos

2.1.1 Visi būtiniai prietaisai

Elektros smūgio pavojus dėl dalių, kuriose yra įtampa!

- Elektrinių konstrukcinių dalių remonto klaidos gali sukelti elektros smūgį!
- Prieš pradėdami dirbti, ne mažiau kaip prieš 60 sekundžių atjunkite prietaisą nuo maitinimo.
- Po remonto pasirūpinkite, kad būtų atliktas saugos bandymas pagal VDE 0701 arba šalyje galiojančius reglamentus.

Pavojus susižeisti į aštrias briaunas!

- Mūvėkite apsaugines pirštines.

Prispaudimo rizika remonto, einamosios techninės priežiūros, sutrikimų šalinimo ir techninės priežiūros metu dėl sunkių ir judančių konstrukcinių dalių

- Avėkite apsauginius batus.
- Apsaugokite sunkias konstrukcines dalis, kad jos nenukristų.
- Neartinkite kūno dalių prie judančių konstrukcinių dalių.







Rizika prietaiso saugai / veikimui!





- Naudokite tik originalias atsargines dalis.

Elektrostatškai jautrių konstrukcinių dalių (ESD) pažeidimo rizika!

- Nelieskite modulių, o taip pat ir jų jungčių bei laidininkų kelių.

Įrankiai ir pagalbinės priemonės

Paskyrimas	Išsami informacija	Vaizdai
Pagalbinis įrankis [15000155]	Įrankis plastikinėms dalims atpalaiduoti	
„Torx T20“ atsuktuvą su kiauryme [00340764]	100 mm, varžtams su saugos kaiščiu	
Dinamometrinis veržliaraktis [15000441]	Dinamometrinis veržliaraktis 20–100 Nm	
Atsuktuvą su įpjova [00340854]	Mentė 3,5 mm x 0,6 mm x 100 mm, apsauginė izoliacija 1000 V AC	
Atsuktuvą su įpjova [00340855]	Mentė 5,5 mm x 1,0 mm x 125 mm, apsauginė izoliacija 1000 V AC	
Adatinės replės, kampinės [00341269]	Ilgis 200 mm	
Šonu pjaunančios replės [00342182]	Ilgis: 200 mm	

Paskyrimas	Išsami informacija	Vaizdai
Kombinuotas veržliaraktis [00340811]	Rakto plotis 10 ^o mm, M6	
Combination wrench [00340814]	Rakto plotis 13 ^o mm, M8	
Kombinuotas veržliaraktis [00340817]	Rakto plotis 17 mm, M10	
Kombinuotas veržliaraktis [15000459]	Rakto plotis 16 ^o mm, M10	

4.1 Stalviršio keitimas

Specialūs įrankiai.

- Tuščiaaviduris TORX antgalis TX20, ilgas 6,3°mm (1/4") 152°mm, varžtams su saugos kaiščiu [00341272]

Reikalavimas.

- ✓ Prietaisas atjungtas nuo maitinimo šaltinio.
- ✓ Prietaisas atjungtas nuo vandens tiekimo.

4.1.1 Stalviršio nuėmimas

- ▶ 1. Išsukite varžtus (1).
- ▶ 2. Nustumkite stalviršį prietaiso galo link (2).
- ▶ 3. Nuimkite stalviršį, keldami jį aukštyn (3).

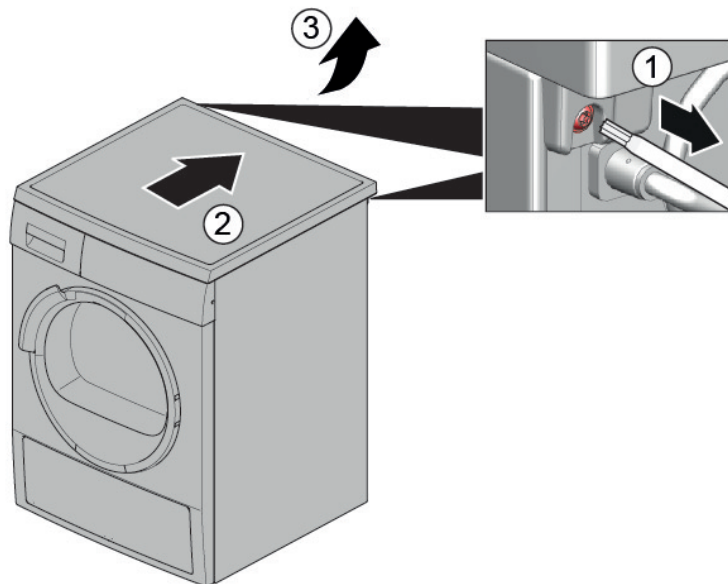

4.1.2 Stalviršio uždėjimas

- ▶ Uždėkite atvirkščia eilės tvarka.

4.2 Antjuostės keitimas



⚠ PERSPĖJIMAS

Aštrios korpuso briaunos!

Galima įsijauti

- ▶ Mūvėkite apsaugines pirštines.



⚠ ĮSPĖJIMAS

Pavestų prietaisų slydimas!

Galimi kaulų lūžiai ir prispaudimai

- ▶ Apsaugokite prietaisus, kad jie nepaslystų.



⚠ PERSPĖJIMAS

Pavojus, kad atpalaidavus varžtus dalys nukris!

Krentančios dalys gali sužeisti.

- ▶ Apsaugokite konstrukcinę dalį, kad ji nenukristų.



DĖMESIO!

Pavojus, kad atpalaidavus varžtus dalys nukris!

Gali būti sugadintos kitos prietaiso dalys arba kliento namai, pvz., grindys.

- ▶ Apsaugokite konstrukcinę dalį, kad ji nenukristų.

Reikalavimas.

- ✓ Prietaisas atjungtas nuo maitinimo šaltinio.
- ✓ Prietaisas atjungtas nuo vandens tiekimo.
- ✓ [Nuimtas stalviršis.→315](#)
- ✓ [Išimtas skalbiklio stalčius.→317](#)

4.2.1 Antjuostės nuėmimas

1. Išsukite varžtus (1).
2. Atpalaiduokite spraudes (2, 3).

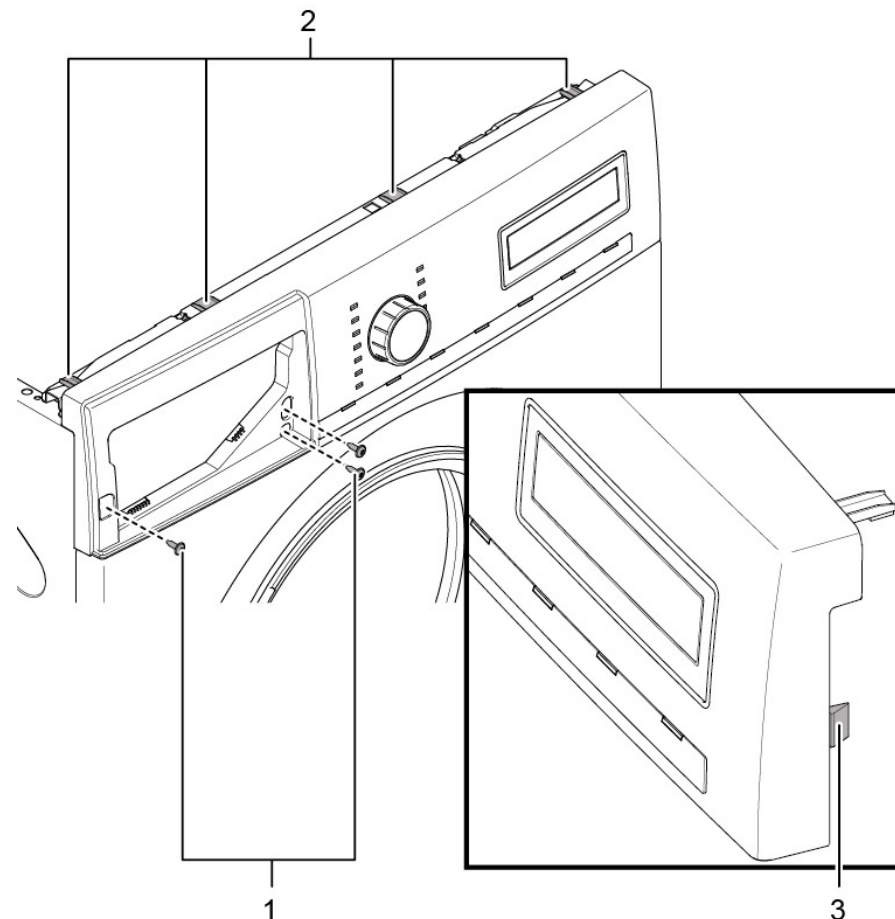

2. Atjunkite valdymo bloko kištukinį kontaktą.
3. Nuimkite antjuostę.

4.2.2 Antjuostės uždėjimas

- ▶ Uždėkite atvirkščia eilės tvarka.

4.3 Skalbiklio stalčiaus keitimas

Reikalavimas.

- ✓ Prietaisas atjungtas nuo maitinimo šaltinio.
- ✓ Prietaisas atjungtas nuo vandens tiekimo.

4.3.1 Skalbiklio stalčiaus išėmimas

1. Ištraukite skalbiklio stalčių.
2. 1. Paspauskite įdėklą (1) žemyn.
2. Išimkite skalbiklio stalčių (2).

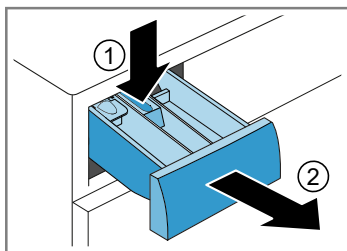

4.3.2 Skalbiklio stalčiaus įdėjimas

- ▶ Uždėkite atvirkščia eilės tvarka.

4.4 Skalbiklio stalčiaus dangtelio keitimas

Reikalavimas.

- ✔ Prietaisas atjungtas nuo maitinimo šaltinio.
- ✔ Prietaisas atjungtas nuo vandens tiekimo.
- ✔ [Išimtas skalbiklio stalčius.→317](#)

4.4.1 Skalbiklio stalčiaus dangtelio nuėmimas

1. Atpalaiduokite spraudes.

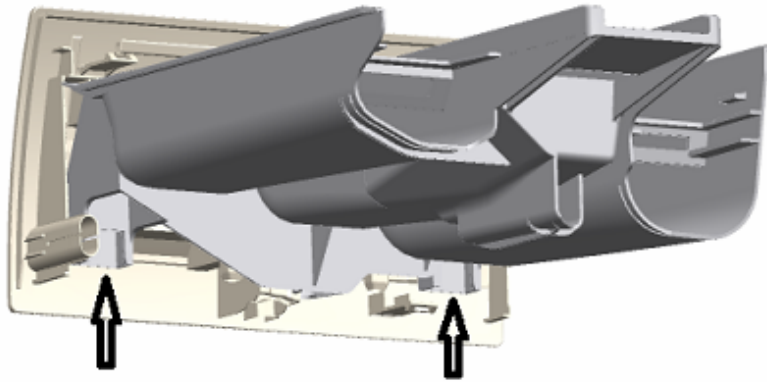

2. Nuimkite skalbiklio stalčiaus dangtelį.

4.4.2 Skalbiklio stalčiaus dangtelio uždėjimas

- ▶ Uždėkite atvirkščia eilės tvarka.

4.5 Durelių keitimas



⚠ PERSPĖJIMAS

Atvira vyrių sritis!

Galima prisispausti / prisiverti pirštus

- ▶ Nekiškite rankų į vyrių sritį.
- ▶ Mūvėkite apsaugines pirštines.

Reikalavimas.

- ✔ Prietaisas atjungtas nuo maitinimo šaltinio.
- ✔ Prietaisas atjungtas nuo vandens tiekimo.
- ✔ Durelės atidarytos.

4.5.1 Durelių nuėmimas

1.



DĖMESIO!

Pavojus, kad atpalaidavus varžtus dalys nukris!

Gali būti sugadintos kitos prietaiso dalys arba kliento namai, pvz., grindys.

- ▶ Apsaugokite konstrukcinę dalį, kad ji nenukristų.



⚠ PERSPĖJIMAS

Pavojus, kad atpalaidavus varžtus dalys nukris!

Krentančios dalys gali sužeisti.

- ▶ Apsaugokite konstrukcinę dalį, kad ji nenukristų.

Išsukite varžtus (1).

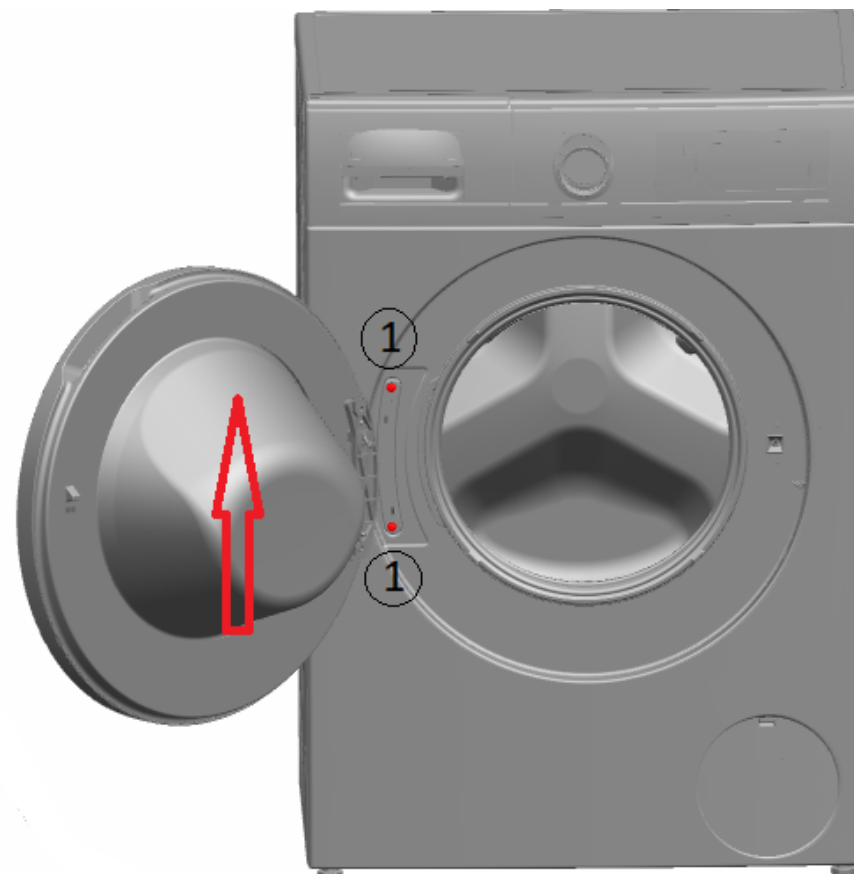

2. Nuimkite dureles, keldami aukštyn.

4.5.2 Durelių uždėjimas

- ▶ Uždėkite atvirkščia eilės tvarka.

4.6 Durelių konstrukcinių dalių keitimas



⚠ PERSPĖJIMAS

Atvira vyrių sritis!

Galima prisispausti / prisiverti pirštus

- ▶ Nekiškite rankų į vyrių sritį.
- ▶ Mūvėkite apsaugines pirštines.

Reikalavimas.

- ✓ Prietaisas atjungtas nuo maitinimo šaltinio.
- ✓ Prietaisas atjungtas nuo vandens tiekimo.
- ✓ [Durelės nuimtos.→319](#)

4.6.1 Durelių konstrukcinių dalių nuėmimas

- ▶ Išardykite dureles nuo išorės vidaus link.

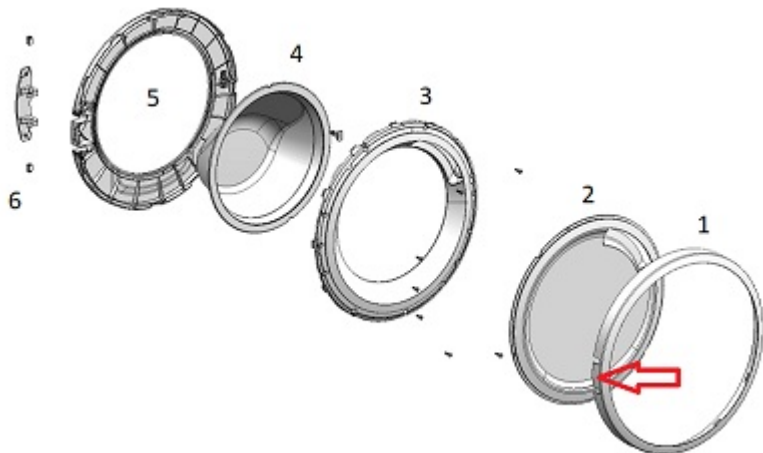



4.6.2 Durelių konstrukcinių dalių uždėjimas

- ▶ Uždėkite atvirkščia eilės tvarka.

4.7 Durelių sandariklio keitimas

	⚠ PERSPĖJIMAS Aštrios korpuso briaunos! Galima įsijpauti ▶ Mūvėkite apsaugines pirštines.
--	--

	⚠ PERSPĖJIMAS Pavojus, kad atpalaidavus varžtus dalys nukris! Krentančios dalys gali sužeisti. ▶ Apsaugokite konstrukcinę dalį, kad ji nenukristų.
--	---

	⚠ DĖMESIO! Pavojus, kad atpalaidavus varžtus dalys nukris! Gali būti sugadintos kitos prietaiso dalys arba kliento namai, pvz., grindys. ▶ Apsaugokite konstrukcinę dalį, kad ji nenukristų.
--	---

Reikalavimas.

- ✓ Prietaisas atjungtas nuo maitinimo šaltinio.
- ✓ Prietaisas atjungtas nuo vandens tiekimo.
- ✓ [Išimtas skalbiklio stalčius.→317](#)
- ✓ [Durelės nuimtos.→319](#)
- ✓ [Siurblio dangtelis nuimtas.→328](#)

4.7.1 Durelių sandariklio nuėmimas

1.		⚠ ĮSPĖJIMAS Paverstų prietaisų slydimas! Galimi kaulų lūžiai ir prispaudimai ▶ Apsaugokite prietaisus, kad jie nepaslystų.
----	---	---

Pakelkite prietaiso priekį.

2. Atpalaiduokite varžtus priekinio skydo apačioje (1).

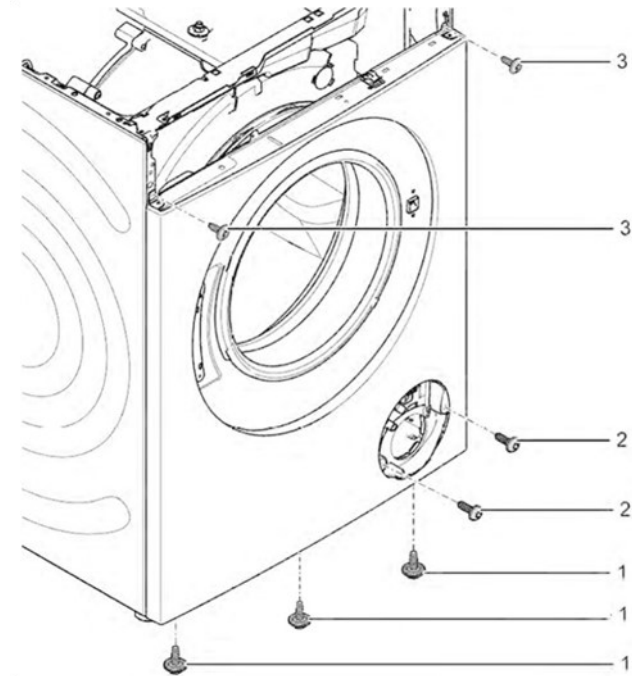

3. Nuleiskite prietaisą.

Remontas

4. Išsukite varžtus siurblio srityje (2).

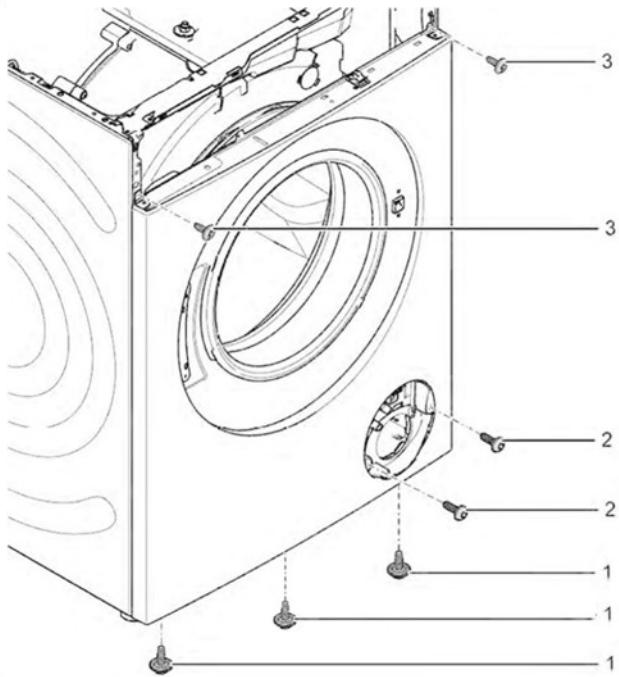

5. 1. Atpalaiduokite varžtus užpakalinėje prietaiso pusėje (1).
2. Nuimkite stalviršį (2, 3).

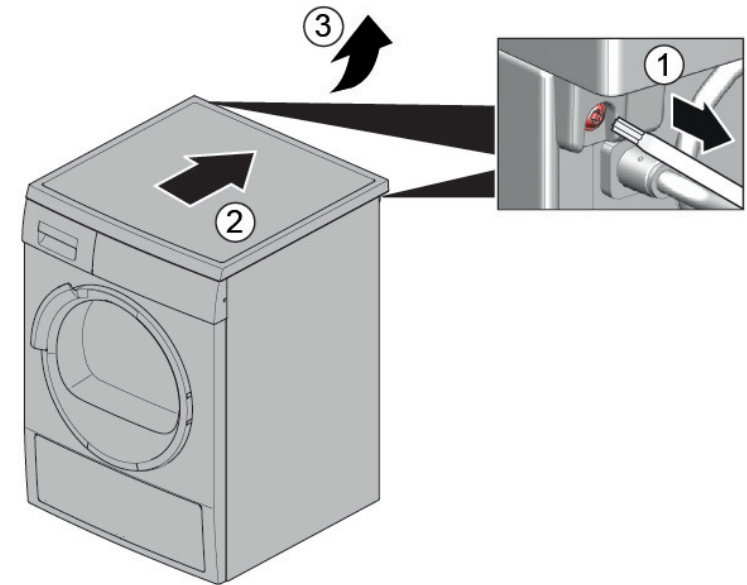

6. 1. Išsukite varžtus (1).
2. Atpalaiduokite antjuostės spraudes (2, 3).
3. Atpalaiduokite dozatoriaus korpuso varžtus.

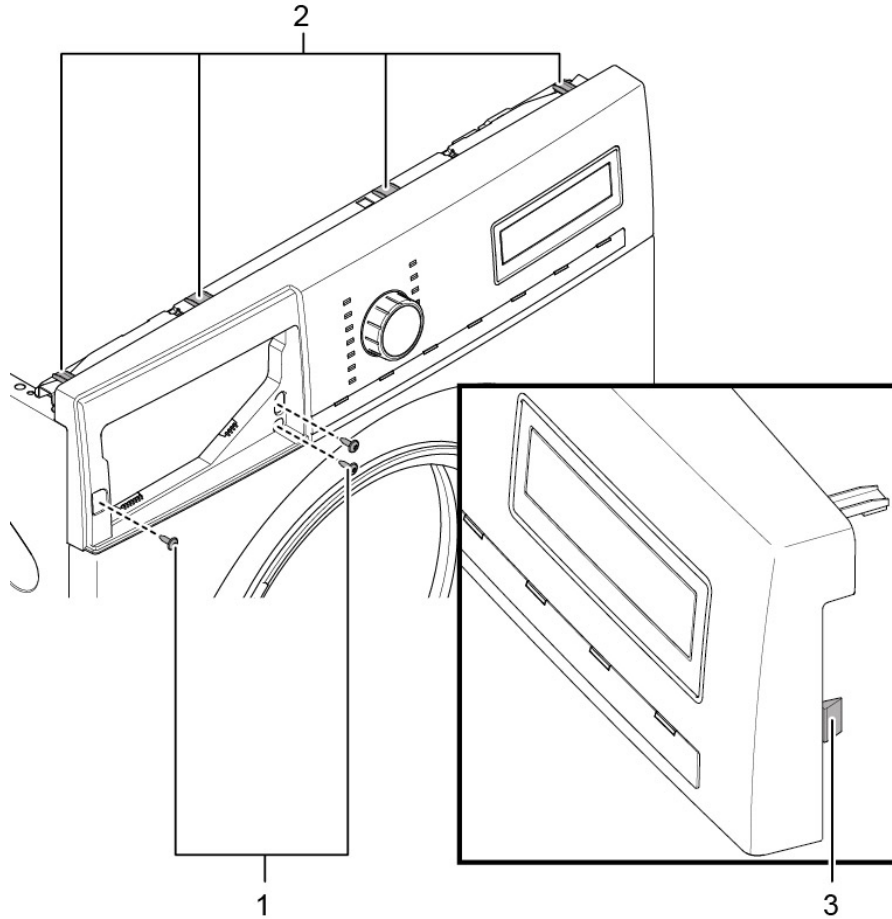

7. Nuimkite antjuostę.

8. Nuimkite viršuje esantį bŕgno apšvietimo laikiklį.

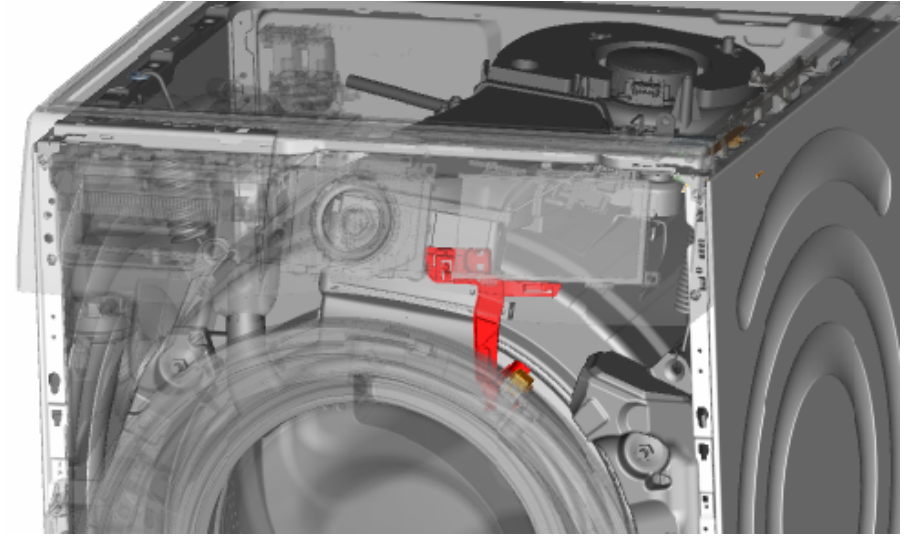

- 9.



DĚMESIO!

Pavojus sugadinti paviršius!

Naudojant netinkamus įrankius galima subraižyti prietaiso paviršių.

- ▶ Norėdami pakeisti veržiamąjį žiedą, naudokite tik plastikinius įrankius.

Plastikiniu įrankiu nuimkite veržiamąjį žiedą nuo tarpinės.

10. Atpalaiduokite durų sandariklį nuo priekinio skydo.
11. Atjunkite nuo durelių užrakto kabelių jungtį.

12. Atpalaiduokite varžtus priekinio skydo viršuje (3).

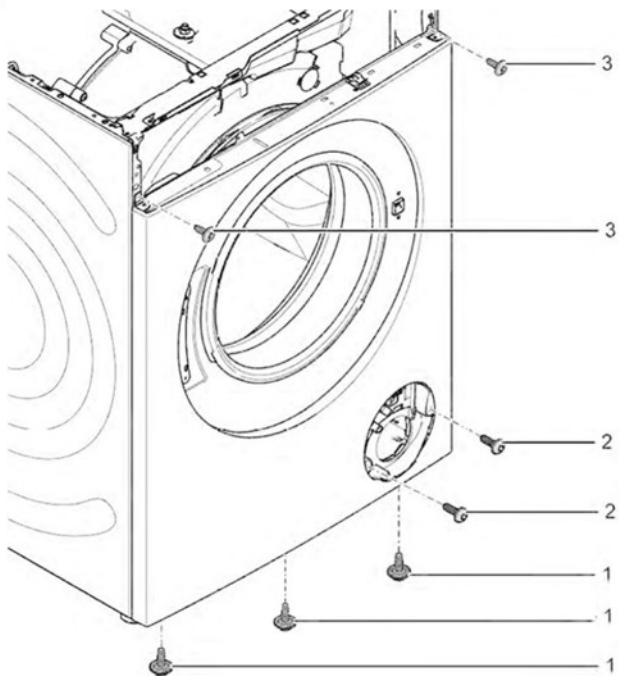

13. Nuimkite priekinį skydą.

14. Atjunkite visas žarnų jungtis.

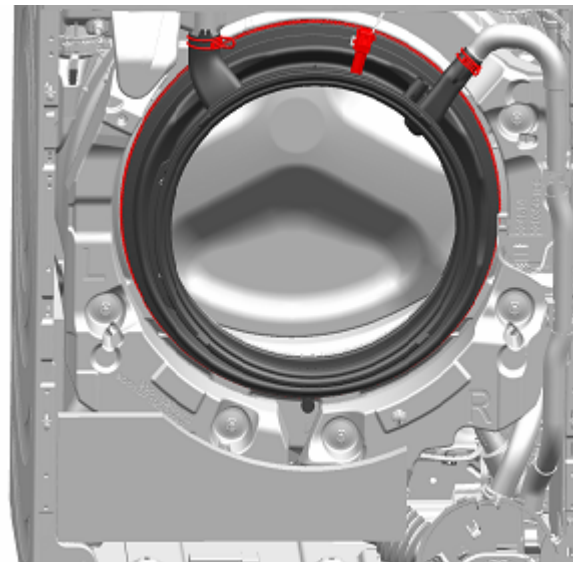

15. Nuimkite durelių sandariklį.

4.7.2 Durelių sandariklio uždėjimas



⚠ ĮSPĖJIMAS

Pavojus, kad netinkamai įrengus nukris dalys!

Susižalojimas arba prietaiso sugadinimas.

▶ Priveržkite durų tarpinės įtempimo žiedą taikydami 3,4 Nm jėgą.

▶ Uždėkite atvirkščia eilės tvarka.

4.8 Durelių užrakto keitimas

Kaip gamintojas, esame įsipareigoję klientams pateikti atsarginį durų užraktą, įskaitant remonto instrukcijas, pagal Reglamentą (ES) 2019/2023. Tačiau norime atkreipti dėmesį, kad pakeitus durų užraktą, prieš pradėdant naudoti prietaisą, kvalifikuotas elektrikas privalo atlikti elektrotechninės saugos bandymą. Šis asmuo turi būti kvalifikuotas pagal šalyje galiojančius įstatymus, reglamentus ir standartus.

	<p>PAVOJUS</p> <p>Elektros smūgio pavojus dėl dalių, kuriose yra įtampa! Pavojus gyvybei dėl elektros smūgio netinkamo remonto atveju</p> <ul style="list-style-type: none">▶ Elektrinės dalis remontuoti turi kvalifikuoti elektrikai.▶ Po remonto pasirūpinkite, kad būtų atliktas saugos bandymas pagal VDE 0701 arba šalyje galiojančius reglamentus.
	<p>PERSPĖJIMAS</p> <p>Aštrios korpuso briaunos! Galima įsipjauti</p> <ul style="list-style-type: none">▶ Mūvėkite apsaugines pirštines.
	<p>ĮSPĖJIMAS</p> <p>Paverstų prietaisų slydimas! Galimi kaulų lūžiai ir prispaudimai</p> <ul style="list-style-type: none">▶ Apsaugokite prietaisus, kad jie nepaslystų.
	<p>PERSPĖJIMAS</p> <p>Pavojus, kad atpalaidavus varžtus dalys nukris! Krentančios dalys gali sužeisti.</p> <ul style="list-style-type: none">▶ Apsaugokite konstrukcinę dalį, kad ji nenukristų.
	<p>DĖMESIO!</p> <p>Pavojus, kad atpalaidavus varžtus dalys nukris! Gali būti sugadintos kitos prietaiso dalys arba kliento namai, pvz., grindys.</p> <ul style="list-style-type: none">▶ Apsaugokite konstrukcinę dalį, kad ji nenukristų.

Reikalavimas.

- ✓ Prietaisas atjungtas nuo maitinimo šaltinio.
- ✓ Prietaisas atjungtas nuo vandens tiekimo.

- ✓ Prietaisai yra laisvai prieinami.
- ✓ [Nuimtas stalviršis.→315](#)
- ✓ Antjuostė nuimta.
- ✓ [Durelės nuimtos.→319](#)
- ✓ Veržiamasis žiedas nuimtas.
- ✓ Priekinis skydas nuimtas.
- ✓ Durelių sandariklis nuimtas.

4.8.1 Durelių užrakto nuėmimas

1. Atjunkite durelių užrakto kištuką.
2. Atpalaiduokite durelių užraktą.



3. Nuimkite durelių užraktą.



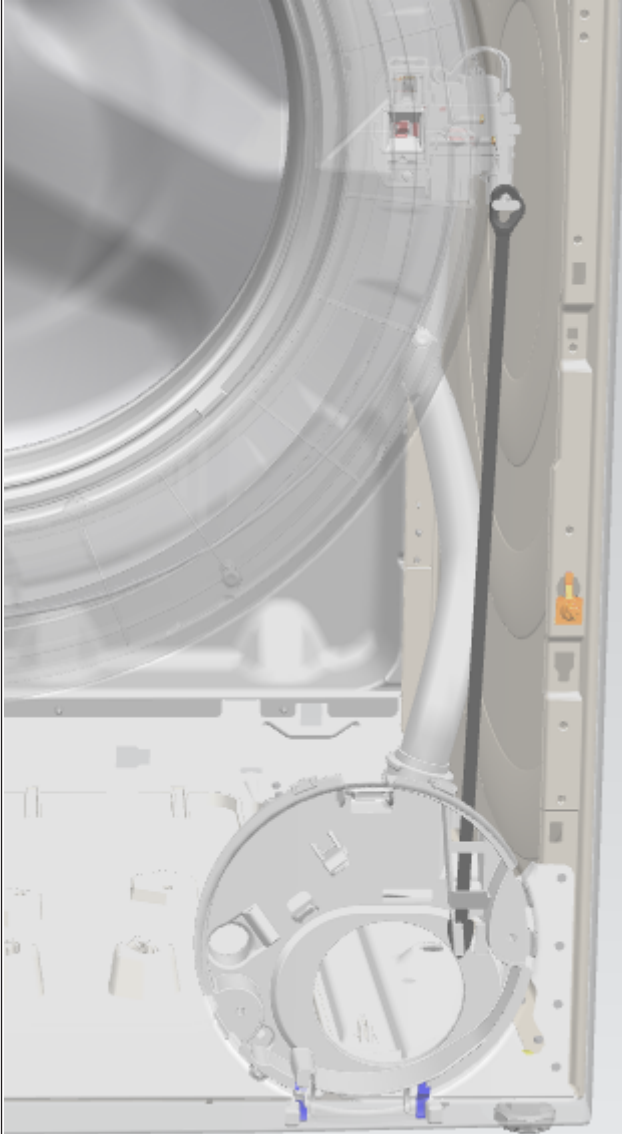

4.8.2 Durelių užrakto sumontavimas

Kad būtų užtikrinta prietaiso avarinio durelių atidarymo funkcija, durelių užraktas turi būti teisingoje padėtyje.



- ▶ Uždėkite atvirkščia eilės tvarka.

4.9 Būgno apšvietimo keitimas

	⚠ PERSPĖJIMAS Aštrios korpuso briaunos! Galima įsijauti ▶ Mūvėkite apsaugines pirštines.
	⚠ ĮSPĖJIMAS Paverstų prietaisų slydimas! Galimi kaulų lūžiai ir prispaudimai ▶ Apsaugokite prietaisus, kad jie nepaslystų.
	⚠ PERSPĖJIMAS Pavojus, kad atpalaidavus varžtus dalys nukris! Krentančios dalys gali sužeisti. ▶ Apsaugokite konstrukcinę dalį, kad ji nenukristų.
	DĖMESIO! Pavojus, kad atpalaidavus varžtus dalys nukris! Gali būti sugadintos kitos prietaiso dalys arba kliento namai, pvz., grindys. ▶ Apsaugokite konstrukcinę dalį, kad ji nenukristų.

Reikalavimas.

- ✔ Prietaisas atjungtas nuo maitinimo šaltinio.
- ✔ Prietaisas atjungtas nuo vandens tiekimo.
- ✔ Prietaisai yra laisvai prieinami.
- ✔ [Nuimtas stalviršis.→315](#)
- ✔ [Išimtas skalbiklio stalčius.→317](#)
- ✔ Antjuostė nuimta.

4.9.1 Būgno apšvietimo nuėmimas

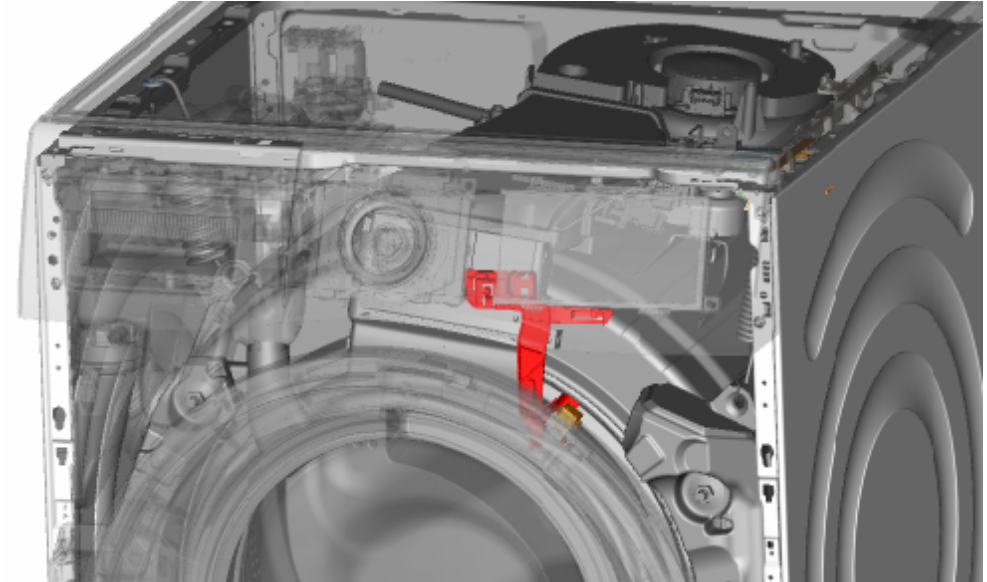

1. Ištraukite būgno apšvietimo laikiklį iš prietaiso.
2. Atjunkite elektros jungtis.
3. Nuimkite būgno apšvietimą nuo apšvietimo laikiklio.

4.9.2 Būgno apšvietimo sumontavimas

- ▶ Uždėkite atvirkščia eilės tvarka.

4.10 Siurblio dangtelio keitimas

Reikalavimas.

- ✔ Prietaisas atjungtas nuo maitinimo šaltinio.
- ✔ Prietaisas atjungtas nuo vandens tiekimo.

4.10.1 Siurblio dangtelio nuėmimas

1. Atidarykite siurblio dangtelį.

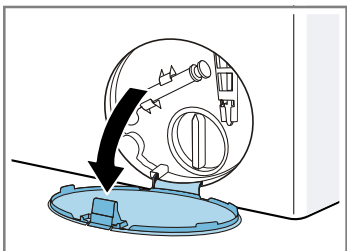

2. Nuimkite siurblio dangtelį.

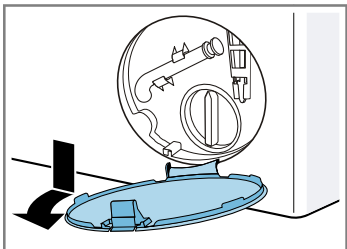

4.10.2 Siurblio dangtelio uždėjimas

- ▶ Uždėkite atvirkščia eilės tvarka.

4.11 Priekinio skydo keitimas



⚠ PERSPĖJIMAS

Aštrios korpuso briaunos!

Galima įsijauti

- ▶ Mūvėkite apsaugines pirštines.

Reikalavimas.

- ✓ Prietaisas atjungtas nuo maitinimo šaltinio.
- ✓ Prietaisas atjungtas nuo vandens tiekimo.
- ✓ [Išimtas skalbiklio stalčius.→317](#)
- ✓ [Durelės nuimtos.→319](#)
- ✓ Durelių sandariklis nuimtas.
- ✓ [Siurblio dangtelis nuimtas.→328](#)

4.11.1 Priekinio skydo nuėmimas

1.



⚠ ĮSPĖJIMAS

Paverstų prietaisų slydimas!

Galimi kaulų lūžiai ir prispaudimai

- ▶ Apsaugokite prietaisus, kad jie nepaslystų.

Pakelkite prietaiso priekį.

2. Išsukite apačioje esančius varžtus (1).

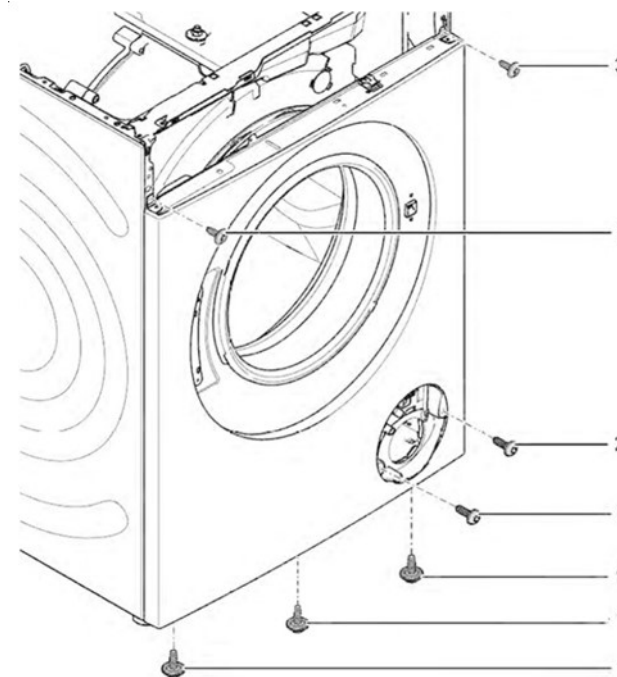

3. Nuleiskite prietaisą.

Remontas

1. Išsukite varžtus (1).
2. Nustumkite stalviršį prietaiso galo link (2).
3. Nuimkite stalviršį, keldami jį aukštyn (3).

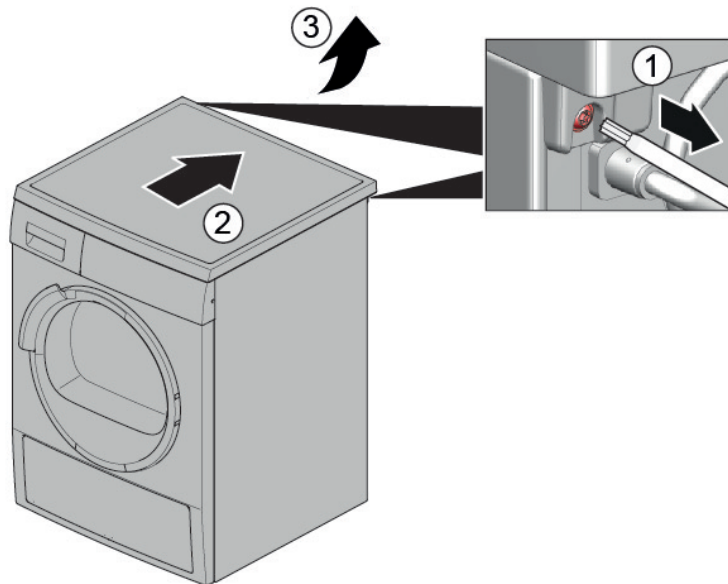

1. Išsukite varžtus (1).
2. Atpalaiduokite spraudes (2, 3).

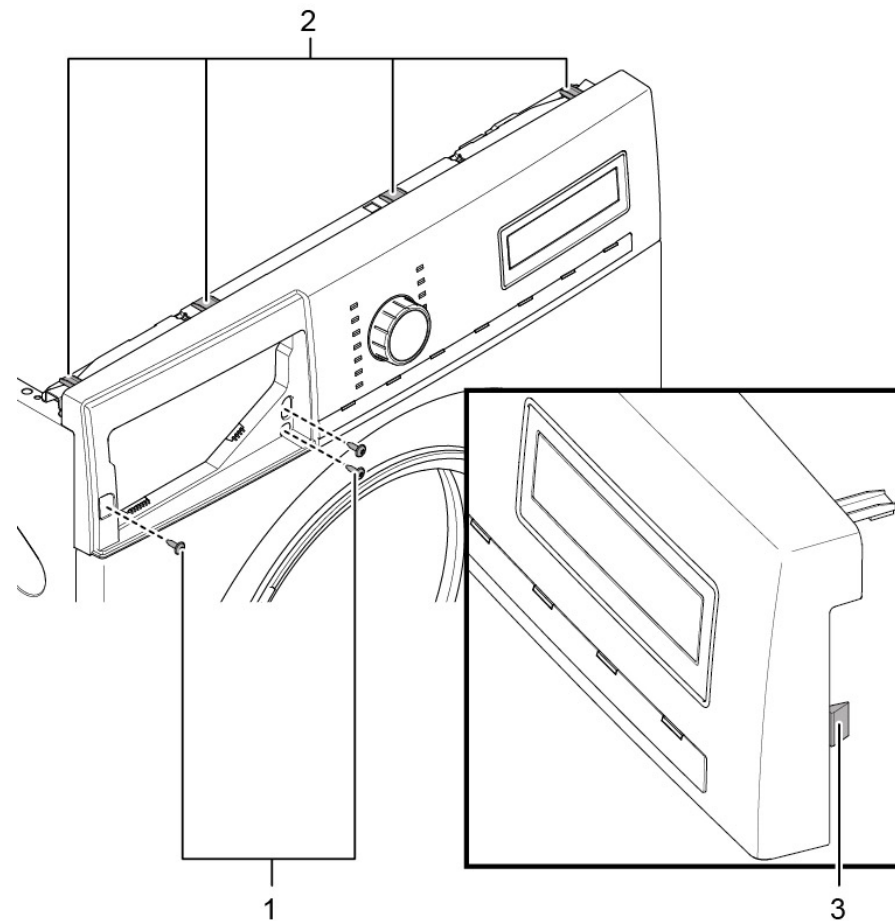

6. Nuimkite antjuostę.

7.



⚠ PERSPĖJIMAS

Pavojus, kad atpalaidavus varžtus dalys nukris!
Krentančios dalys gali sužeisti.

- ▶ Apsaugokite konstrukcinę dalį, kad ji nenukristų.



DĖMESIO!

Pavojus, kad atpalaidavus varžtus dalys nukris!

Gali būti sugadintos kitos prietaiso dalys arba kliento namai, pvz., grindys.

- ▶ Apsaugokite konstrukcinę dalį, kad ji nenukristų.

Išsukite priekyje esančius varžtus, pradėdami nuo varžtų apačioje, o tada – viršuje (2, 3).

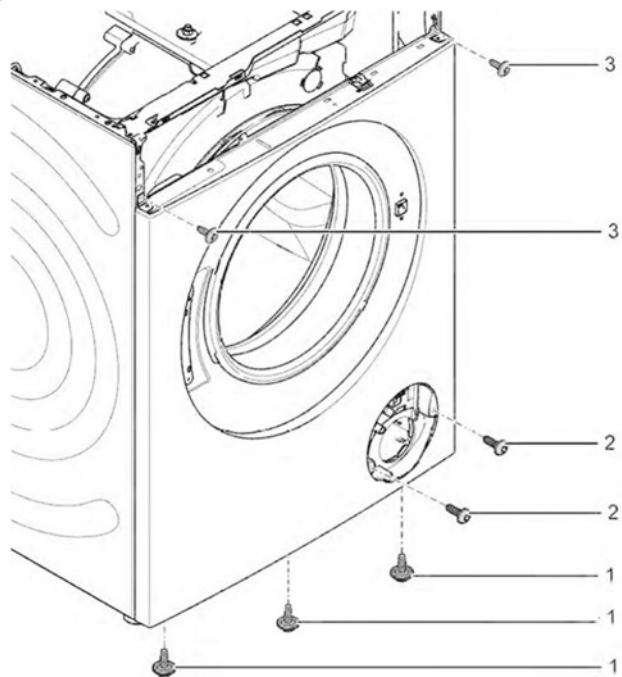

8. Nuimkite priekinį skydą.

4.11.2 Priekinio skydo uždėjimas

- ▶ Uždėkite atvirkščia eilės tvarka.

Reparasjonstips - Vaskemaskin

 Om dette dokumentet	333
1.1 Viktig informasjon	333
1.1.1 Formål.....	333
1.2 Forklaring av symboler.....	333
1.2.1 Farenivåer	333
1.2.2 Faresymboler.....	333
1.2.3 Advarslenes struktur	334
1.2.4 Generelle symboler	334
 Sikkerhet	335
2.1 Generelle sikkerhetsinstruksjoner	335
2.1.1 Alle husholdningsapparater	335
 Verktøy og hjelpemidler	336
 Reparasjon	337
4.1 Utskiftning av arbeidsplate	337
4.1.1 Demontering av arbeidsplate	337
4.1.2 Montering av arbeidsplate	337
4.2 Utskiftning av instrumentpanel.....	338
4.2.1 Demontering av instrumentpanel.....	338
4.2.2 Montering av instrumentpanel	338
4.3 Utskiftning av vaskemiddelskuff.....	339
4.3.1 Demontering av vaskemiddelskuff.....	339
4.3.2 Montering av vaskemiddelskuff	339
4.4 Utskiftning av håndtak på vaskemiddelskuff	340
4.4.1 Demontering av håndtak på vaskemiddelskuff	340
4.4.2 Montering av håndtak på vaskemiddelskuff.....	340
4.5 Utskiftning av dør	341
4.5.1 Demontering av dør	341
4.5.2 Montering av dør.....	341
4.6 Utskiftning av dørkomponenter.....	342
4.6.1 Demontering av dørkomponenter.....	342
4.6.2 Montering av dørkomponenter	342
4.7 Utskiftning av dørpakning.....	343
4.7.1 Demontering av dørpakning.....	343
4.7.2 Montering av dørpakning.....	346

4.8 Utskiftning av dørlås.....	347
4.8.1 Demontering av dørlås.....	347
4.8.2 Montering av dørlås	348
4.9 Utskiftning av lampe i trommel	349
4.9.1 Demontering av lampe i trommel	349
4.9.2 Montering av lampe i trommel	349
4.10 Utskiftning av pumpedeksel	350
4.10.1 Demontering av pumpedeksel	350
4.10.2 Montering av pumpedeksel	350
4.11 Utskiftning av frontpanel	351
4.11.1 Demontering av frontpanel	351
4.11.2 Montering av frontpanel	353

i Om dette dokumentet

1.1 Viktig informasjon

1.1.1 Formål

Disse tipsene om reparasjon skal hjelpe kunden til selv å kunne reparere apparater i samsvar med gjeldende regulering av øko-design (med gyldighet 03/2021).





De inneholder informasjon om hvordan definerte reservedeler skiftes, inklusive advarsler og risikoer.

Kontakt vår kundeservice dersom du har spørsmål. Vi påtar oss kun ansvar for skader dersom tipsene om reparasjon er korrekt fulgt.

1.2 Forklaring av symboler

1.2.1 Farenivåer

Advarslene som viser farenivå, består av et symbol og et signalord. Signalordet viser hvor alvorlig faren er.





Advarsel som viser farenivå	Betydning
	Dersom advarselen ignoreres, vil det føre til død eller alvorlige personskader.
	Dersom advarselen ignoreres, kan det føre til død eller alvorlige personskader.
	Dersom advarselen ignoreres, kan det føre til mindre personskader.
	Dersom advarselen ignoreres, kan det føre til materiell skade.

Tabell 1: Farenivåer



1.2.2 Faresymboler

Faresymboler er symbolske fremstillinger som gir en indikasjon av hvilken type fare det dreier seg om.

Følgende faresymboler brukes i dette dokumentet:

Faresymbol	Betydning
	Generell advarsel
	Fare for elektrisk støt
	Eksplisjonsfare
	Fare for å skjære seg
	Klemfare

i Om dette dokumentet

Faresymbol	Betydning
	Fare på grunn av varme overflater
	Fare på grunn av sterkt magnetfelt
	Fare fra ikke-ioniserende stråling

Tabell 2: Faresymboler

1.2.3 Advarslenes struktur

Advarslene i dette dokumentet har standardisert utseende og standardisert struktur.



	<div style="background-color: red; color: white; padding: 2px; text-align: center;">FARE</div> <p>Faretype og kilde til fare! Mulige konsekvenser dersom fare/advarsel ignoreres.</p> <ul style="list-style-type: none"> ▶ Tiltak og forbud for å forebygge fare.
--	--







Eksemplet nedenfor viser en advarsel mot elektrisk støt på grunn av strømførende deler. Tiltaket for å unngå faren er angitt.

	<div style="background-color: red; color: white; padding: 2px; text-align: center;">FARE</div> <p>Fare for elektrisk støt på grunn av strømførende deler! Død på grunn av drepende elektrisk støt</p> <ul style="list-style-type: none"> ▶ Koble apparatene fra strømforsyningen i minst 60 sekunder før reparasjonene startes.
---	--

1.2.4 Generelle symboler

Følgende generelle symboler brukes i dette dokumentet:

Gen. symbol	Betydning
	Identifisering av et spesielt tips (tekst og/eller grafikk)
	Identifisering av et enkelt tips (kun tekst)
	Identifisering av en lenke til en opplæringsvideo

Gen. symbol	Betydning
	Identifisering av nødvendig verktøy
	Identifisering av nødvendige forutsetninger
	Identifisering av en betingelse (hvis ..., så ...)
	Identifisering av et resultat
	Identifisering av en tast eller knapp
	Identifisering av et materialnummer
	Identifisering av vist tekst/vindu (i apparatets display)

Tabell 3: Generelle symboler

2.1 Generelle sikkerhetsinstruksjoner

2.1.1 Alle husholdningsapparater

Fare for elektrisk støt på grunn av strømførende deler!

- Feil ved reparasjoner hvor elektriske komponenter er involvert, kan føre til elektrisk støt!
- Koble apparatet fra strømmettet i minst 60 sekunder før arbeidet startes.
- Etter reparasjonen må du sørge for at det utføres en sikkerhetstest iht. VDE 0701 eller gjeldende forskrifter i det respektive land.

Fare for personskade på grunn av skarpe kanter!

- Bruk vernehansker.

Fare for å knuse legemsdeler under reparasjoner, vedlikehold, feilsøking og service på grunn av tunge og bevegelige komponenter

- Bruk vernesko.
- Sikre tunge komponenter for å hindre at de faller ned.
- Ikke stikk kroppsdelene inn i bevegelige komponenter.







Fare for apparatets sikkerhet/funksjon!





- Bruk kun originale reservedeler.

Fare for skade på deler som er følsomme overfor elektrostatisk utlading (ESD)!

- Ikke berør modulene, inklusive tilkoblinger og ledere.

Verktøy og hjelpemidler

Betegnelse	Detaljer	Bilder
Hjelpeverktøy [15000155]	Verktøy for å løsne plastdeler	
Torx T20-skrutrekker med borehull [00340764]	100 mm, for skruer med splint	
Momentnøkkel [15000441]	Momentnøkkel 20 - 100 Nm	
Flat skrutrekker [00340854]	Blad 3,5 mm x 0,6 mm x 100 mm, beskyttende isolasjon 1000 V AC	
Flat skrutrekker [00340855]	Blad 5,5 mm x 1,0 mm x 125 mm, beskyttende isolasjon 1000 V AC	
Spisstang, vinkelmonster [00341269]	Lengde 200 mm	
Avbitertang [00342182]	Lengde: 200 mm	



Betegnelse	Detaljer	Bilder
Fastnøkkel [00340811]	Størrelse på fastnøkkel 10°mm, M6	
Combination wrench [00340814]	Størrelse på fastnøkkel 13°mm, M8	
Fastnøkkel [00340817]	Størrelse på fastnøkkel 17 mm, M10	
Fastnøkkel [15000459]	Størrelse på fastnøkkel 16°mm, M10	

4.1 Utskiftning av arbeidsplate

Spesielle hjelpemidler:

-  Torx-bits TX20 med hull, langt 6,3°mm (1/4") 152°mm, for skruer med splint [00341272]

Forutsetning:

-  Apparatet kobles fra strømforsyningen.
-  Apparatet kobles fra vannforsyningen.

4.1.1 Demontering av arbeidsplate

- ▶ 1. Fjern skruene (1).
- ▶ 2. Skyv arbeidsplaten til baksiden av apparatet (2).
- ▶ 3. Beveg arbeidsplaten opp (3) for å fjerne den.

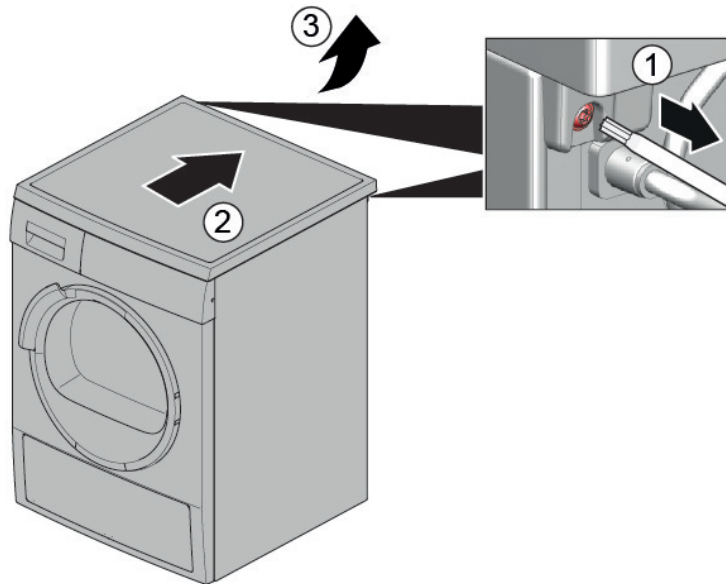

4.1.2 Montering av arbeidsplate

- ▶ Monteres i motsatt rekkefølge.

4.2 Utskiftning av instrumentpanel

	⚠ FORSIKTIG Skarpe kanter på hus! Kuttskader ▶ Bruk vernehansker.
--	--

	⚠ ADVARSEL Tiltede apparater kan skli ut! Beinbrudd/klemskader ▶ Sikre apparatene mot å skli ut.
--	---

	⚠ FORSIKTIG Fare for at deler kan falle ned på grunn av løsnede skruer! Personskade på grunn av fallende deler. ▶ Sikre komponenten så den ikke kan falle ned.
--	---

	OBS! Fare for at deler kan falle ned på grunn av løsnede skruer! Skade på andre deler på apparatet eller i kundens hjem, f.eks. gulv. ▶ Sikre komponenten så den ikke kan falle ned.
--	---

Forutsetning:

- ✔ Apparatet kobles fra strømforsyningen.
- ✔ Apparatet kobles fra vannforsyningen.
- ✔ [Arbeidsplaten er demontert.→337](#)
- ✔ [Vaskemiddelskuffen er tatt ut.→339](#)

4.2.1 Demontering av instrumentpanel

1. Fjern skruene (1).
2. Løsne låselementene (2, 3).

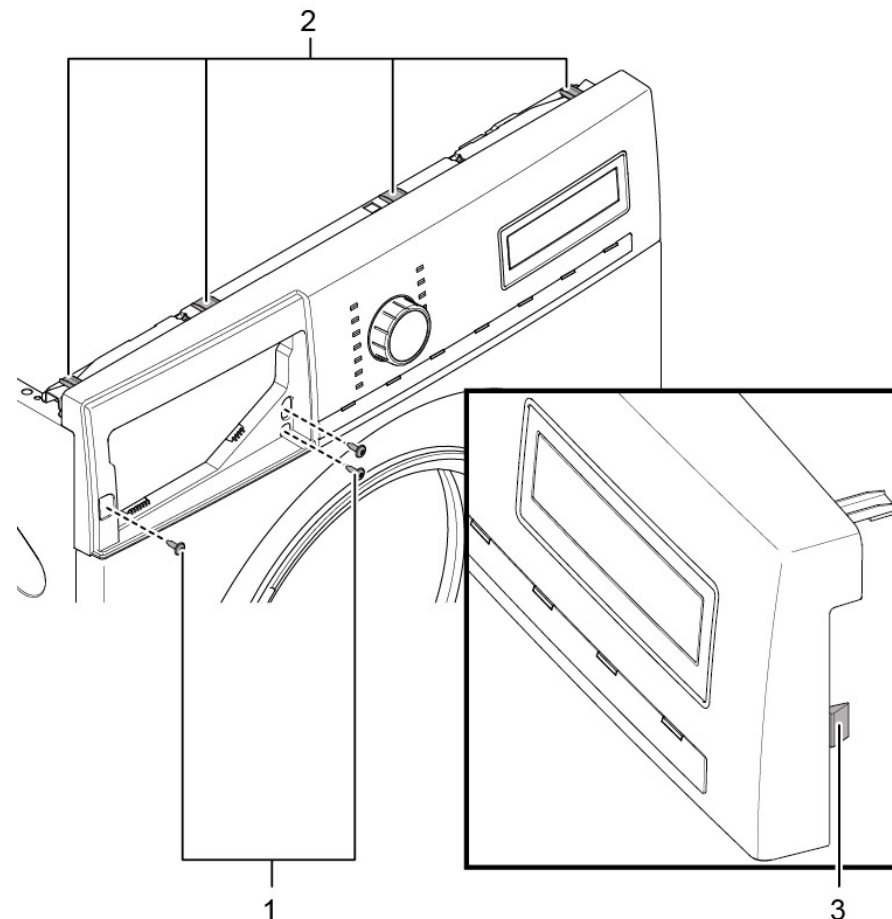

2. Løsne kontrollenhetens pluggkontakt.
3. Demonter instrumentpanelet.

4.2.2 Montering av instrumentpanel

- ▶ Monteres i motsatt rekkefølge.

4.3 Utskiftning av vaskemiddelskuff

Forutsetning:

- ✓ Apparatet kobles fra strømforsyningen.
- ✓ Apparatet kobles fra vannforsyningen.

4.3.1 Demontering av vaskemiddelskuff

1. Trekk ut vaskemiddelskuffen.
2. 1. Trykk innsatsen ned (1).
2. Ta ut vaskemiddelskuffen (2).

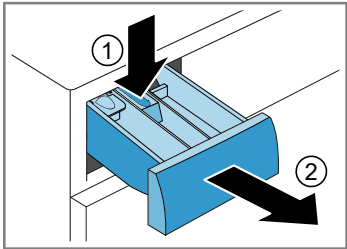

4.3.2 Montering av vaskemiddelskuff

- ▶ Monteres i motsatt rekkefølge.

4.4 Utskiftning av håndtak på vaskemiddelskuff

Forutsetning:

- ✓ Apparatet kobles fra strømforsyningen.
- ✓ Apparatet kobles fra vannforsyningen.
- ✓ [Vaskemiddelskuffen er tatt ut. → 339](#)

4.4.1 Demontering av håndtak på vaskemiddelskuff

1. Løsne låselementene.

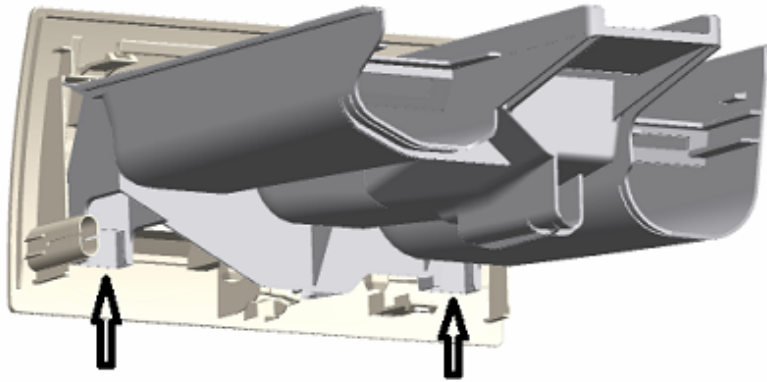

2. Demonter håndtaket på vaskemiddelskuffen.

4.4.2 Montering av håndtak på vaskemiddelskuff

- ▶ Monteres i motsatt rekkefølge.

4.5 Utskiftning av dør



⚠ FORSIKTIG

Åpent hengsleområde!

Fare for å knuse/sette fast fingre

- ▶ Ikke grip inn i hengsleområdet.
- ▶ Bruk vernehansker.

Forutsetning:

- ✔ Apparatet kobles fra strømforsyningen.
- ✔ Apparatet kobles fra vannforsyningen.
- ✔ Døren er åpen.

4.5.1 Demontering av dør

1.



OBS!

Fare for at deler kan falle ned på grunn av løsnede skruer!

Skade på andre deler på apparatet eller i kundens hjem, f.eks. gulv.
▶ Sikre komponenten så den ikke kan falle ned.



⚠ FORSIKTIG

Fare for at deler kan falle ned på grunn av løsnede skruer!

Personskade på grunn av fallende deler.

- ▶ Sikre komponenten så den ikke kan falle ned.

Fjern skruene (1).

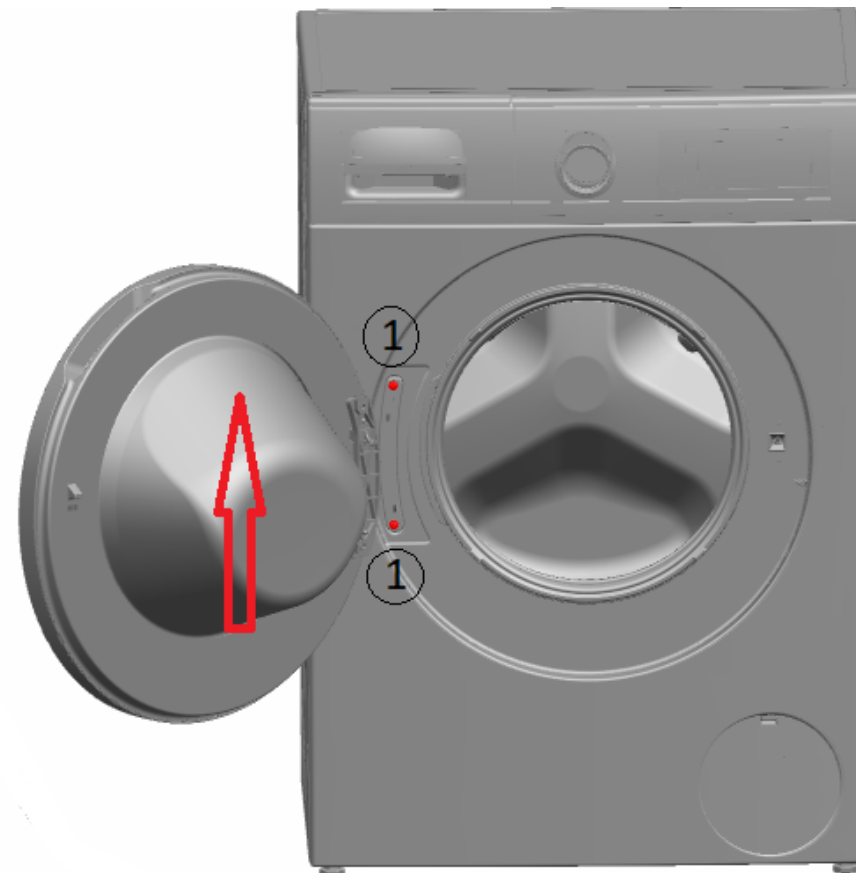

2. Ta ut døren mot oppsiden.

4.5.2 Montering av dør

- ▶ Monteres i motsatt rekkefølge.

4.6 Utskiftning av dørkomponenter



⚠️ FORSIKTIG

Åpent hengsleområde!

Fare for å knuse/sette fast fingre

- ▶ Ikke grip inn i hengsleområdet.
- ▶ Bruk vernehansker.

Forutsetning:

- ✔ Apparatet kobles fra strømforsyningen.
- ✔ Apparatet kobles fra vannforsyningen.
- ✔ [Døren er demontert.→341](#)

4.6.1 Demontering av dørkomponenter

- ▶ Ta døren fra hverandre fra utsiden til innsiden.

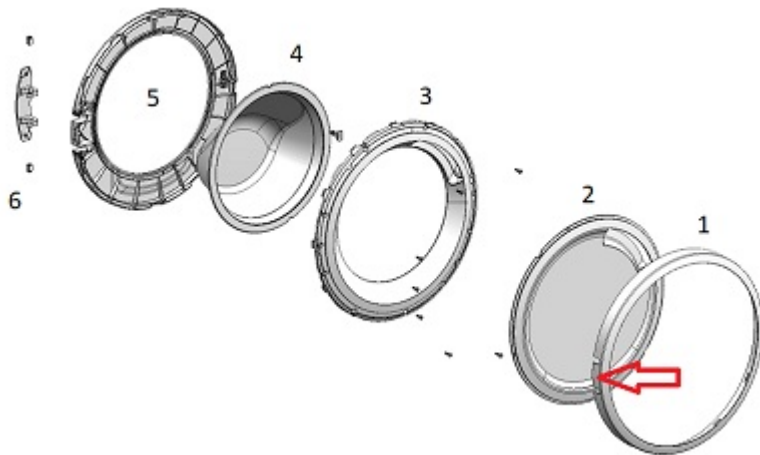

4.6.2 Montering av dørkomponenter

- ▶ Monteres i motsatt rekkefølge.

4.7 Utskiftning av dørpakning



FORSIKTIG

Skarpe kanter på hus!
Kuttskader
▶ Bruk vernehansker.



FORSIKTIG

Fare for at deler kan falle ned på grunn av løsnede skruer!
Personskade på grunn av fallende deler.
▶ Sikre komponenten så den ikke kan falle ned.



OBS!

Fare for at deler kan falle ned på grunn av løsnede skruer!
Skade på andre deler på apparatet eller i kundens hjem, f.eks. gulv.
▶ Sikre komponenten så den ikke kan falle ned.

Forutsetning:

- ✓ Apparatet kobles fra strømforsyningen.
- ✓ Apparatet kobles fra vannforsyningen.
- ✓ [Vaskemiddelskuffen er tatt ut.→339](#)
- ✓ [Døren er demontert.→341](#)
- ✓ [Pumpedekslet er fjernet.→350](#)

4.7.1 Demontering av dørpakning

1.



ADVARSEL

Tiltede apparater kan skli ut!
Beinbrudd/klemskader
▶ Sikre apparatene mot å skli ut.

Løft opp apparatet foran.

2. Løsne skruene nederst på fronten (1).

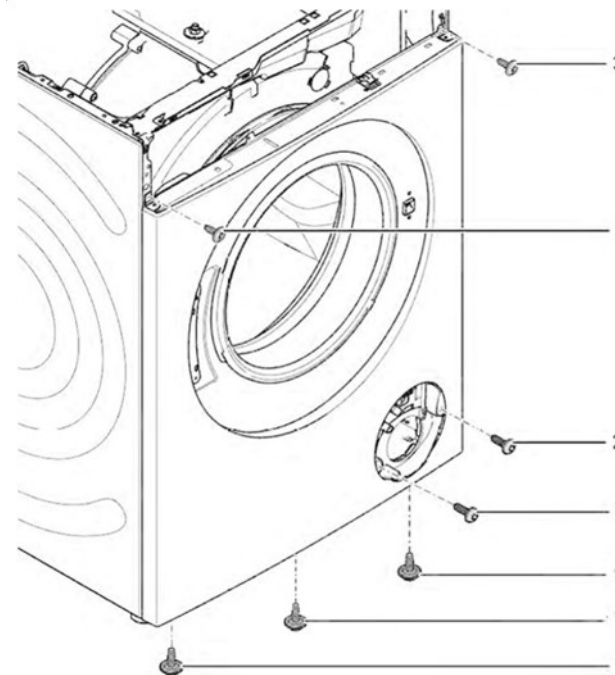

3. Senk apparatet ned.

Reparasjon

4. Fjern skruene i pumpeområdet (2).

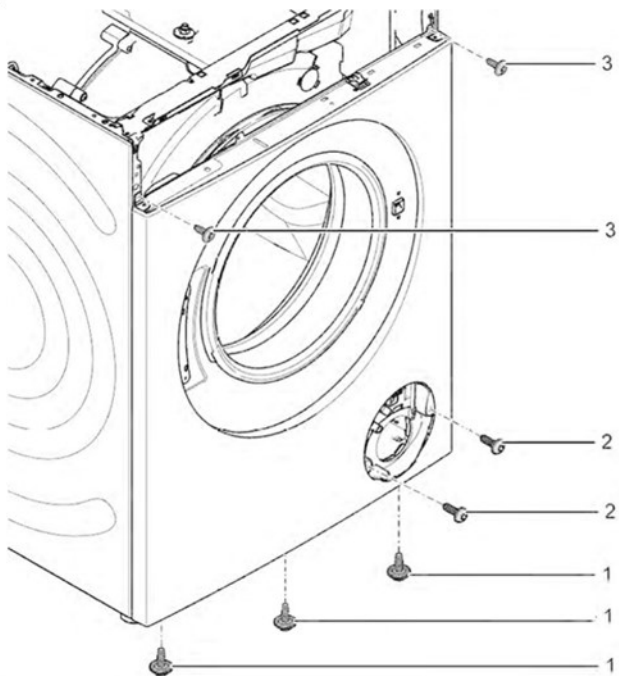

5. 1. Løsne skruene på baksiden av apparatet (1).
2. Ta av arbeidsplaten (2, 3).

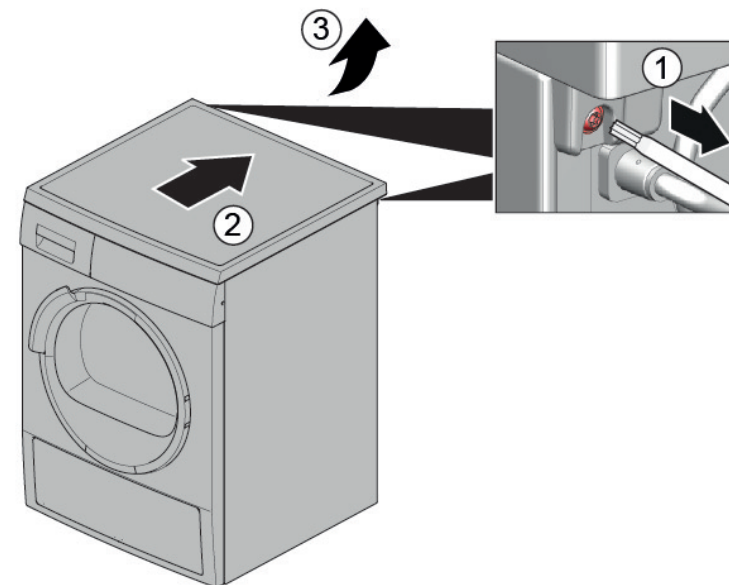

Reparasjon

6. 1. Fjern skruene (1).
2. Løsne instrumentpanelets låselementer (2, 3).
3. Løsne skruene i dispenserhuset.

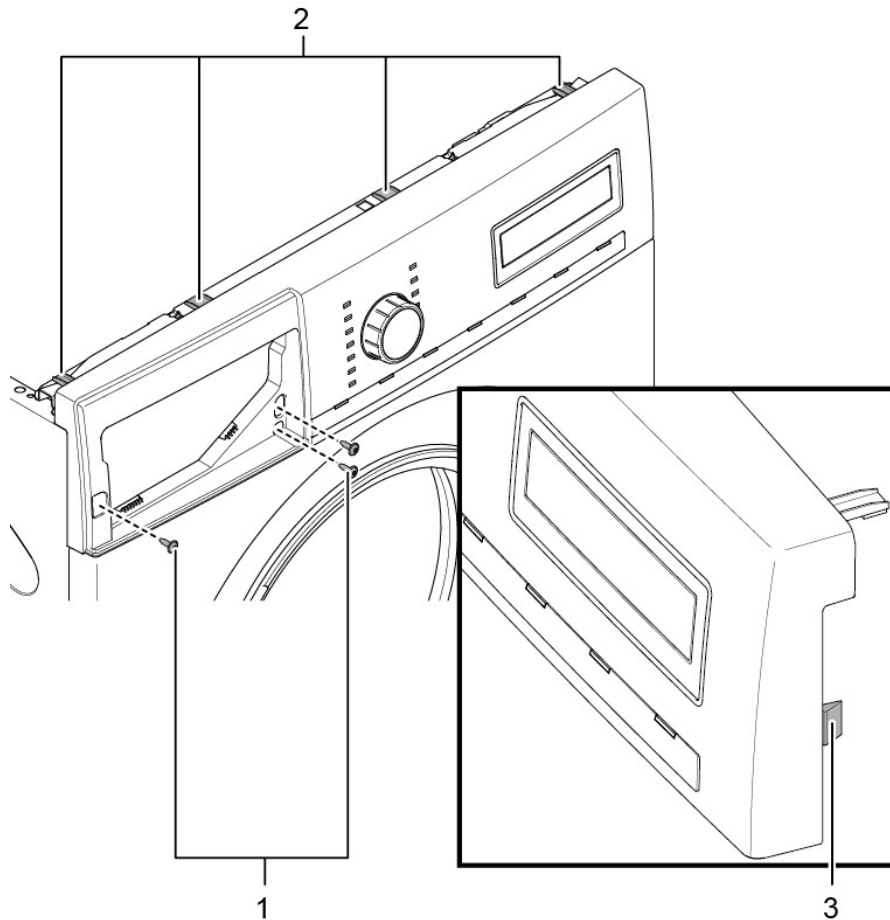

7. Demonter instrumentpanelet.

8. Demonter trommellampeholderen på toppen.

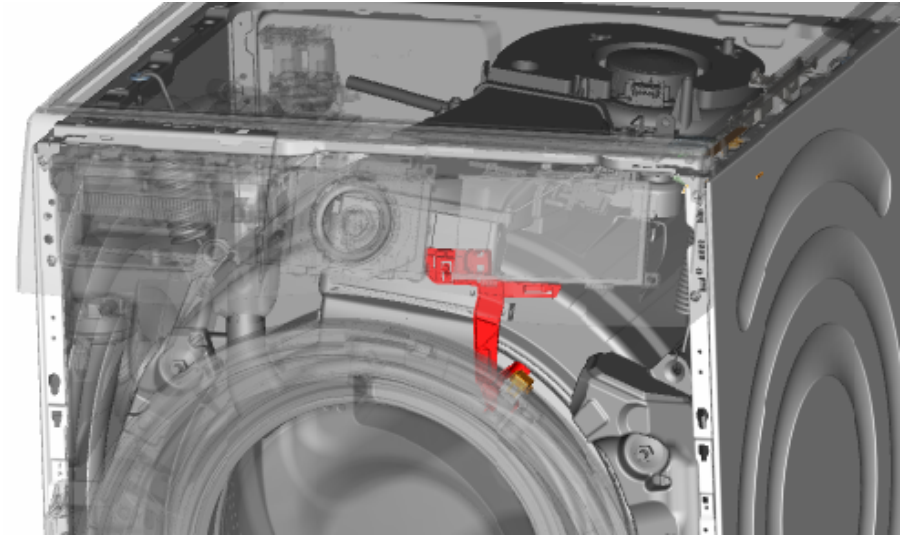

- 9.



OBS!

Fare for skader på overflaten!

Apparatets overflate kan få riper ved bruk av feil verktøy.

- Bruk bare plastverktøy når du skal skifte ut stramringen.

Fjern stramringen fra pakningen med et plastverktøy.

10. Løsne dørpakningen fra frontpanelet.
11. Løsne kabelkontakten fra dørlåsen.

12. Løsne skruene på toppen av frontpanelet (3).

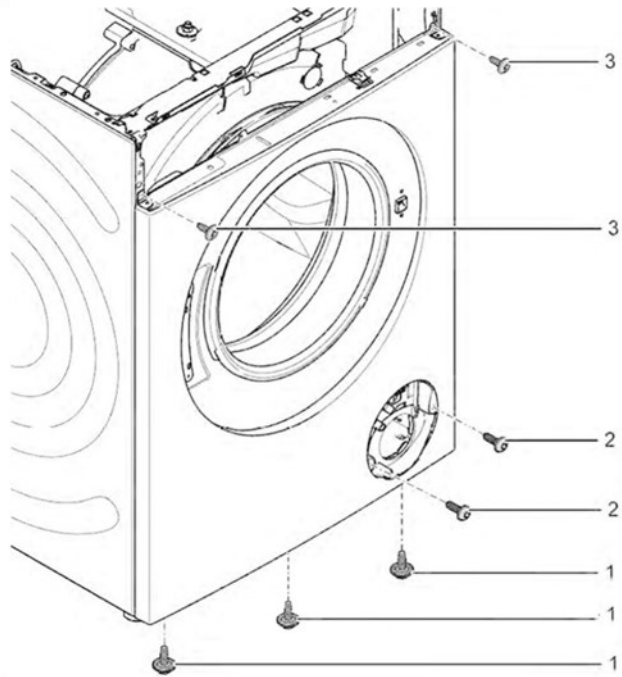

13. Demonter frontpanelet.

14. Løsne alle slangekoblingene.

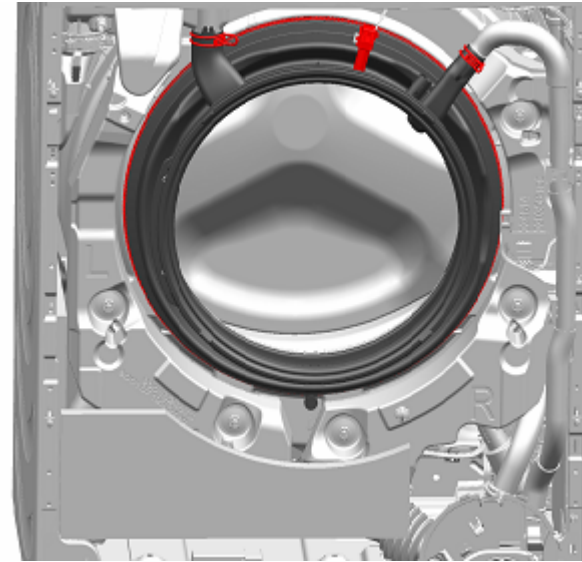

15. Demonter dørpakningen.

4.7.2 Montering av dørpakning



ADVARSEL

Fare for at deler kan falle ned på grunn feil montering!





Personskade eller skade på apparatet.

- ▶ Trekk til gummpakningens stramming med 3,4 Nm.

- ▶ Monteres i motsatt rekkefølge.

4.8 Utskiftning av dørlås

I egenskap av produsent er vi forpliktet til å stille til rådighet for forbrukerne reserve- delen dørlås inkl. reparasjonsveiledning i samsvar med direktiv (EU) 2019/2023. Men vi vil gjøre oppmerksom på at det etter utskiftning av en dørlås må utføres en elektroteknisk sikkerhetstest av en kvalifisert elektriker før apparatet tas i bruk. Denne personen må kunne dokumentere at hun/han er kvalifisert i henhold til gjeldende lover, forskrifter og standarder i det respektive land.

	<p>⚠️ FARE</p> <p>Fare for elektrisk støt på grunn av strømførende deler! Livsfare på grunn av elektrisk støt ved feil reparasjon</p> <ul style="list-style-type: none">▶ Elektriske deler skal repareres av kvalifiserte elektrikere.▶ Etter reparasjonen må du sørge for at det utføres en sikkerhets- test iht. VDE 0701 eller gjeldende forskrifter i det respektive land.
	<p>⚠️ FORSIKTIG</p> <p>Skarpe kanter på hus! Kuttskader</p> <ul style="list-style-type: none">▶ Bruk vernehansker.
	<p>⚠️ ADVARSEL</p> <p>Tiltede apparater kan skli ut! Beinbrudd/klemskader</p> <ul style="list-style-type: none">▶ Sikre apparatene mot å skli ut.
	<p>⚠️ FORSIKTIG</p> <p>Fare for at deler kan falle ned på grunn av løsnede skruer! Personskade på grunn av fallende deler.</p> <ul style="list-style-type: none">▶ Sikre komponenten så den ikke kan falle ned.
	<p>OBS!</p> <p>Fare for at deler kan falle ned på grunn av løsnede skruer! Skade på andre deler på apparatet eller i kundens hjem, f.eks. gulv.</p> <ul style="list-style-type: none">▶ Sikre komponenten så den ikke kan falle ned.

Forutsetning:

- ✔️ Apparatet kobles fra strømforsyningen.
- ✔️ Apparatet kobles fra vannforsyningen.

- ✔️ Apparatet er fritt tilgjengelig.
- ✔️ [Arbeidsplaten er demontert.→337](#)
- ✔️ Instrumentpanelet er demontert.
- ✔️ [Døren er demontert.→341](#)
- ✔️ Strammeringen er demontert.
- ✔️ Frontpanelet er demontert.
- ✔️ Dørpakningen er demontert.

4.8.1 Demontering av dørlås

1. Koble fra dørens låseplugg.
2. Løsne dørlåsen.



3. Demonter dørlåsen.

4.8.2 Montering av dørlås

Dørlåsen må være i korrekt posisjon for å sikre nødfunksjonen for åpning av døren på apparatet.





- ▶ Monteres i motsatt rekkefølge.

4.9 Utskiftning av lampe i trommel

	⚠ FORSIKTIG Skarpe kanter på hus! Kuttskader ▶ Bruk vernehansker.
--	--

	⚠ ADVARSEL Tiltede apparater kan skli ut! Beinbrudd/klemskader ▶ Sikre apparatene mot å skli ut.
--	---

	⚠ FORSIKTIG Fare for at deler kan falle ned på grunn av løsnede skruer! Personskade på grunn av fallende deler. ▶ Sikre komponenten så den ikke kan falle ned.
--	---

	OBS! Fare for at deler kan falle ned på grunn av løsnede skruer! Skade på andre deler på apparatet eller i kundens hjem, f.eks. gulv. ▶ Sikre komponenten så den ikke kan falle ned.
--	---

Forutsetning:

- ✔ Apparaten kobles fra strømforsyningen.
- ✔ Apparaten kobles fra vannforsyningen.
- ✔ Apparaten er fritt tilgjengelig.
- ✔ [Arbeidsplaten er demontert. → 337](#)
- ✔ [Vaskemiddelskuffen er tatt ut. → 339](#)
- ✔ Instrumentpanelet er demontert.

4.9.1 Demontering av lampe i trommel

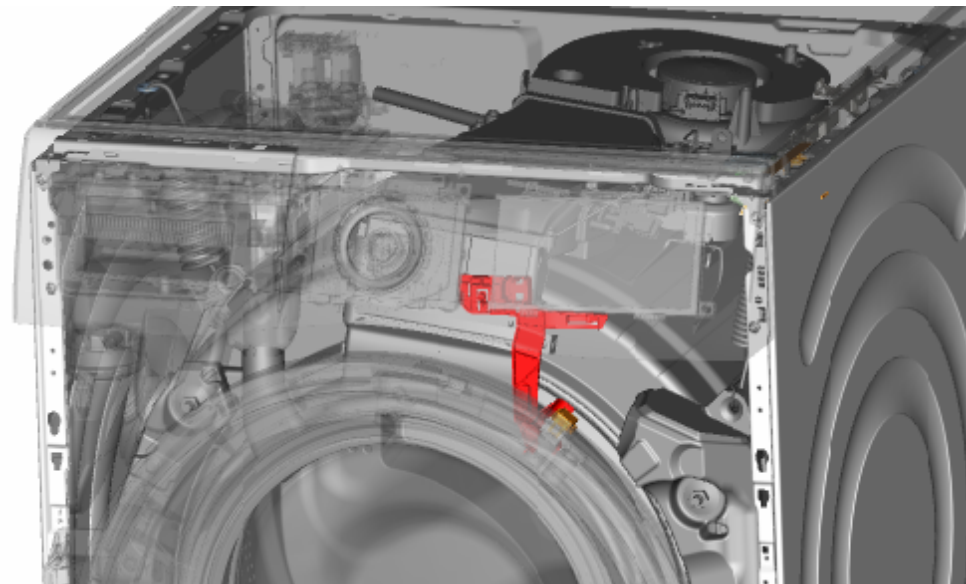

1. Trekk trommellampeholderen ut av apparatet.
2. Koble fra de elektriske tilkoblingene.
3. Demonter trommellampen fra trommellampeholderen.

4.9.2 Montering av lampe i trommel

- ▶ Monteres i motsatt rekkefølge.

4.10 Utskiftning av pumpedeksel

Forutsetning:

- ✓ Apparatet kobles fra strømforsyningen.
- ✓ Apparatet kobles fra vannforsyningen.

4.10.1 Demontering av pumpedeksel

1. Åpne pumpedekslet.

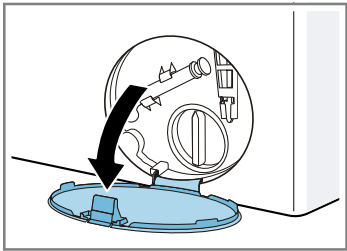

2. Ta av pumpedekslet.

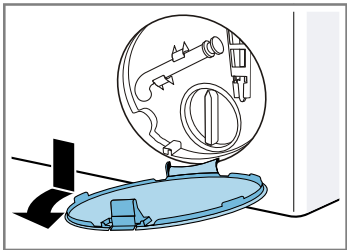

4.10.2 Montering av pumpedeksel

- ▶ Monteres i motsatt rekkefølge.

4.11 Utskiftning av frontpanel



⚠️ FORSIKTIG

Skarpe kanter på hus!
Kuttskader
▶ Bruk vernehansker.

Forutsetning:

- ✓ Apparatet kobles fra strømforsyningen.
- ✓ Apparatet kobles fra vannforsyningen.
- ✓ [Vaskemiddelskuffen er tatt ut. →339](#)
- ✓ [Døren er demontert. →341](#)
- ✓ Dørpakningen er demontert.
- ✓ [Pumpedekslet er fjernet. →350](#)

4.11.1 Demontering av frontpanel

1.



⚠️ ADVARSEL

Tiltede apparater kan skli ut!
Beinbrudd/klemskader
▶ Sikre apparatene mot å skli ut.

Løft opp apparatet foran.

2. Fjern skruene nederst (1).

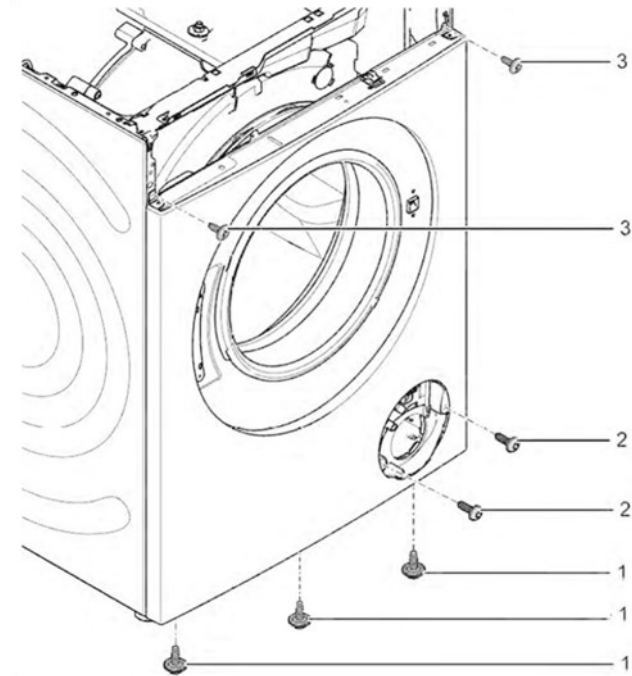

3. Senk apparatet ned.

Reparasjon

4. 1. Fjern skruene (1).
2. Skyv arbeidsplaten til baksiden av apparatet (2).
3. Beveg arbeidsplaten opp (3) for å fjerne den.

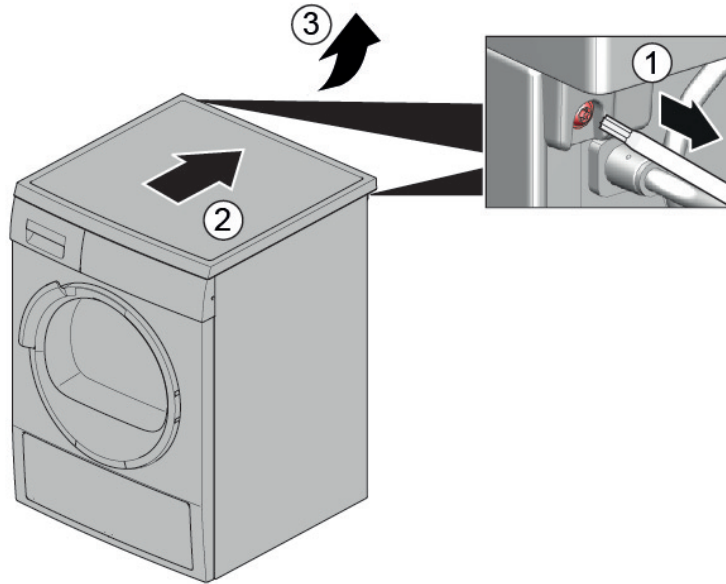

5. 1. Fjern skruene (1).
2. Løsne låselementene (2, 3).

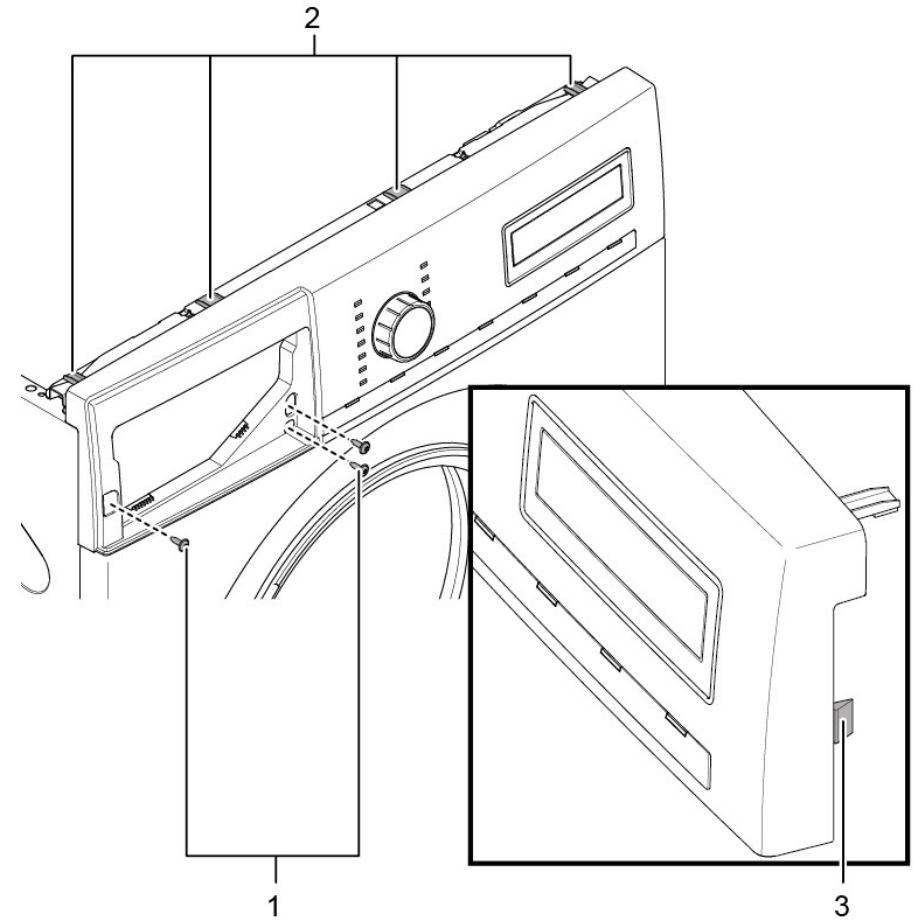

6. Demonter instrumentpanelet.

7.



⚠ FORSIKTIG

Fare for at deler kan falle ned på grunn av løsnede skruer!
Personskade på grunn av fallende deler.
► Sikre komponenten så den ikke kan falle ned.



OBS!

Fare for at deler kan falle ned på grunn av løsnede skruer!
Skade på andre deler på apparatet eller i kundens hjem, f.eks. gulv.
► Sikre komponenten så den ikke kan falle ned.

Fjern skruene på fronten; nedenfra og opp (2, 3).

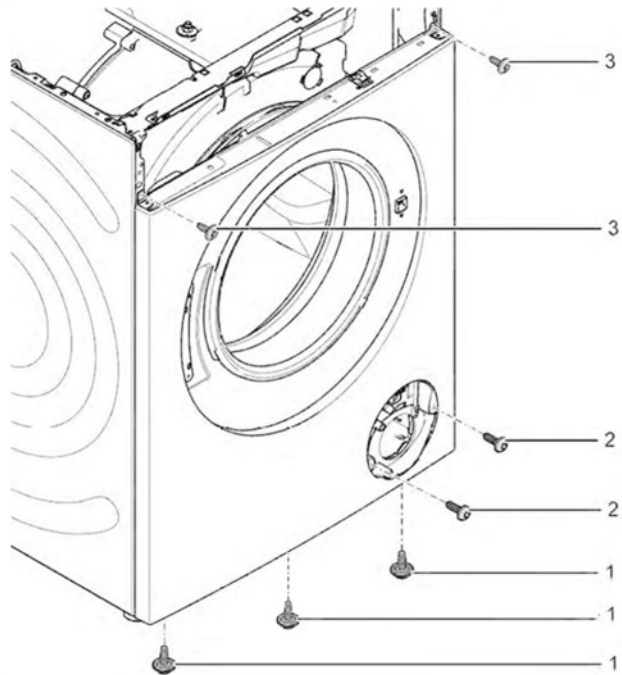

8. Demonter frontpanelet.

4.11.2 Montering av frontpanel

► Monteres i motsatt rekkefølge.

Wskazówki naprawy - Pralka

Informacje dotyczące dokumentu 355

1.1	Ważne informacje	355
1.1.1	Cel dokumentu	355
1.2	Objaśnienie symboli ostrzegawczych	355
1.2.1	Oznaczenie poziomów niebezpieczeństwa	355
1.2.2	Symbole ostrzegawcze	355
1.2.3	Budowa ostrzeżeń	356
1.2.4	Ogólne symbole	356

Bezpieczeństwo 357

2.1	Ogólne informacje dotyczące bezpieczeństwa	357
2.1.1	Wszystkie sprzęty gospodarstwa domowego	357

Narzędzia i pomoce techniczne 358

Naprawy 359

4.1	Wymiana blatu roboczego	359
4.1.1	Demontaż blatu roboczego	359
4.1.2	Montaż blatu roboczego	359
4.2	Wymiana panelu przedniego	360
4.2.1	Demontaż panelu przedniego	360
4.2.2	Montaż panelu przedniego	360
4.3	Wymiana dozownika detergentu	361
4.3.1	Demontaż dozownika detergentu	361
4.3.2	Montaż dozownika detergentu	361
4.4	Wymiana uchwyty dozownika detergentu	362
4.4.1	Demontaż uchwyty dozownika detergentu	362
4.4.2	Montaż uchwyty dozownika detergentu	362
4.5	Wymiana drzwi	363
4.5.1	Demontaż drzwi	363
4.5.2	Montaż drzwi	363
4.6	Wymiana komponentów drzwiczek	364
4.6.1	Demontaż komponentów drzwiczek	364
4.6.2	Montaż komponentów drzwiczek	364
4.7	Wymiana uszczelki drzwi	365
4.7.1	Demontaż uszczelki drzwi	365
4.7.2	Montaż uszczelki drzwi	368

4.8	Wymiana blokady drzwi	369
4.8.1	Demontaż blokady drzwi	369
4.8.2	Montaż blokady drzwi	370
4.9	Wymiana oświetlenia bębna	371
4.9.1	Demontaż oświetlenia bębna	371
4.9.2	Montaż oświetlenia bębna	371
4.10	Wymiana osłony pompy	372
4.10.1	Demontaż osłony pompy	372
4.10.2	Montaż osłony pompy	372
4.11	Wymiana ściany przedniej	373
4.11.1	Demontaż ściany przedniej	373
4.11.2	Montaż ściany przedniej	375

i Informacje dotyczące dokumentu

1.1 Ważne informacje

1.1.1 Cel dokumentu

Niniejsze wskazówki naprawcze mają na celu zapewnienie użytkownikowi pomocy w samodzielnej naprawie posiadanych urządzeń w sposób zgodny z obowiązującymi przepisami w sprawie ekoprojektu (stan na 03/2021).

Zawierają one informacje na temat wymiany określonych części zamiennych oraz ostrzeżenia i informacje o zagrożeniach.

W razie pytań należy się skontaktować z naszym działem serwisowym. Odpowiedzialność za szkody ponosimy tylko pod warunkiem prawidłowego stosowania się do wskazówek naprawczych.

1.2 Objasnienie symboli ostrzegawczych

1.2.1 Oznaczenie poziomów niebezpieczeństwa

Poziom ryzyka jest określany przy pomocy symbolu oraz wyrazu. Wyraz określa poziom ryzyka.



Symbol	Znaczenie
 NIEBEZPIECZEŃSTWO	Bezpośrednio zagrażające niebezpieczeństwo, które przy niezachowaniu odpowiednich środków ostrożności może doprowadzić do śmierci lub poważnych obrażeń.
 OSTRZEŻENIE	Prawdopodobieństwo wystąpienia niebezpieczeństwa, które przy niezachowaniu odpowiednich środków ostrożności może doprowadzić do śmierci lub poważnych obrażeń.
 WAŻNE	Prawdopodobieństwo wystąpienia niebezpieczeństwa, które przy niezachowaniu odpowiednich środków ostrożności może doprowadzić do powstania lekkich obrażeń.
UWAGA!	Ostrzeżenie dot. możliwości powstania szkody materialnej.

Tabela 1: Oznaczenie poziomów niebezpieczeństwa

1.2.2 Symbole ostrzegawcze

Symbole ostrzegawcze reprezentują graficznie źródło potencjalnego ryzyka.

W poniższym dokumencie użyto następujących symboli:

Symbole ostrzegawcze	Znaczenie
	Ogólne ostrzeżenie
	Niebezpieczeństwo od napięcia elektrycznego
	Ryzyko wybuchu

i Informacje dotyczące dokumentu







Symbole ostrzegawcze	Znaczenie
	Ryzyko obrażeń (rozcięć)
	Ryzyko zmiążdżenia
	Ryzyko oparzenia
	Silne pole magnetyczne
	Promieniowanie nie-jonizujące

Tabela 2: Symbole ostrzegawcze

1.2.3 Budowa ostrzeżeń

Ostrzeżenia podane w dokumencie mają standardową budowę.

	<p>⚠ NIEBEZPIECZEŃSTWO</p> <p>Typ i źródło ryzyka!! Konsekwencje zignorowania.</p> <ul style="list-style-type: none"> ▶ Środki ochronne.
---	---

Kolejne ostrzeżenie wskazuje, jako źródło możliwość porażenia prądem. Wskazano czynności, które mają za zadanie ograniczenie ryzyka.

	<p>⚠ NIEBEZPIECZEŃSTWO</p> <p>Ryzyko porażenia prądem, ze względu na elementy będące pod napięciem! Zagrożenie życia poprzez porażenie prądem</p> <ul style="list-style-type: none"> ▶ Odłączyć urządzenie od zasilania sieciowego na 60 sekund przed rozpoczęciem naprawy.
--	--

1.2.4 Ogólne symbole

Poniższe symbole są używane w dokumentacji:







Symbol	Znaczenie
	Identyfikacja specjalnej wskazówki (tekst lub grafika)
	Identyfikacja prostej wskazówki (tylko tekst)
	Identyfikacja linku do pliku wideo
	Identyfikacja narzędzi
	Identyfikacja wstępnych warunków
	Identyfikacja warunku (jeżeli)
	Identyfikacja rezultatu
[Start]	Identyfikacja przycisku
[00123456]	Identyfikacja numeru materiału
Status	Identyfikacja wyświetlanego tekstu / komunikatu (na wyświetlaczu)

Tabela 3: Ogólne symbole

2.1 Ogólne informacje dotyczące bezpieczeństwa

2.1.1 Wszystkie sprzęty gospodarstwa domowego

Ryzyko porażenia prądem elektrycznym wskutek kontaktu z elementami znajdującymi się pod napięciem!

- Błędna naprawa części elektrycznych może spowodować porażenie prądem elektrycznym!
- Co najmniej 60 sekund przed przystąpieniem do pracy odłączyć urządzenie od sieci elektrycznej.
- Po naprawie należy przeprowadzić test bezpieczeństwa zgodny z przepisami normy VDE 0701 (Niemcy) lub odpowiednimi przepisami obowiązującymi w kraju użytkownika.

Ryzyko zranienia o ostre krawędzie!

- Używać rękawic ochronnych.

Ryzyko zmiżdżenia podczas naprawy, obsługi lub diagnozy, ze względu na ciężkie i ruchome elementy

- Stosować obuwie ochronne.
- Zabezpieczyć ciężkie elementy przed upadkiem.
- Nie dotykać ruchomych elementów podczas pracy urządzenia.







Zagrożenie dla bezpieczeństwa użytkownika i działania urządzenia!





- Używać tylko oryginalnych części zamiennych.

Ryzyko uszkodzenia komponentów wrażliwych na wyładowania elektrostatyczne (ESD)!

- Nie dotykać modułów, włącznie ze złączami i ścieżkami przewodzącymi.

Narzędzia i pomoce techniczne

Przeznaczenie	Detale	Zdjęcia
Narzędzie pomocnicze [15000155]	Narzędzie do poluzowania plastikowych części	
Śrubokręt typu Torx T20 z gniazdem [00340764]	100 mm, do wkrętów z trzpieniem zabezpieczającym	
Klucz dynamometryczny [15000441]	Klucz dynamometryczny 20 - 100 Nm	
Śrubokręt z końcówką płaską [00340854]	Końcówka 3,5 mm x 0,6 mm x 100 mm, izolacja ochronna 1000 V AC	
Śrubokręt z końcówką płaską [00340855]	Końcówka 5,5 mm x 1,0 mm x 125 mm, izolacja ochronna 1000 V AC	
Szczypce wydłużone, wygięte [00341269]	Długość 200 mm	
Szczypce z nożami bocznymi [00342182]	Długość: 200 mm	



Przeznaczenie	Detale	Zdjęcia
Klucz płasko-oczkowy [00340811]	Rozmiar klucza 10 ^o mm, M6	
Combination wrench [00340814]	Rozmiar klucza 13 ^o mm, M8	
Klucz płasko-oczkowy [00340817]	Rozmiar klucza 17 mm, M10	
Klucz płasko-oczkowy [15000459]	Rozmiar klucza 16 ^o mm, M10	

4.1 Wymiana blatu roboczego

Pomoce specjalne

-  Torx Bit TX20 z dziurą, długość 6.3°mm (1/4") 152°mm, dla wkrętów z [00341272] trzpieniem zabezpieczającym

Warunek:

-  Urządzenie odłączone od źródła zasilania.
-  Urządzenie jest odłączone od źródła wody.

4.1.1 Demontaż blatu roboczego

- ▶ 1. Wykręcić śruby (1).
- ▶ 2. Przesunąć blat roboczy w stronę tyłu urządzenia (2).
- ▶ 3. Podnieść blat roboczy do góry (3), aby go zdjąć.

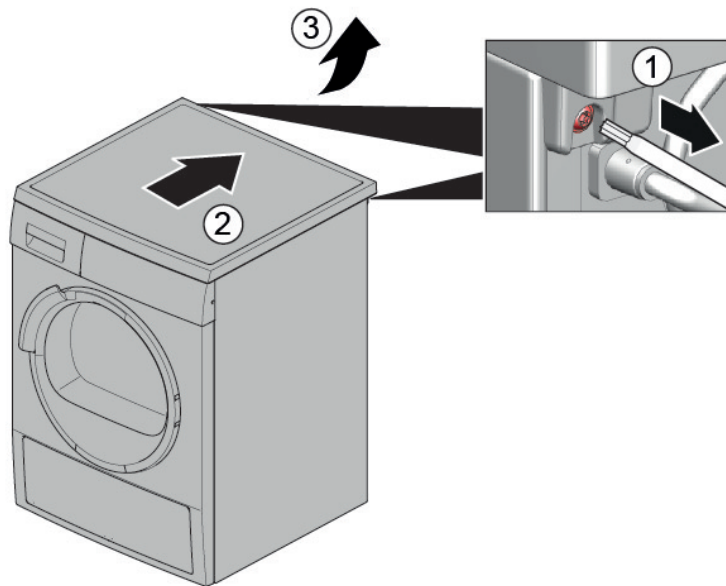

4.1.2 Montaż blatu roboczego

- ▶ Montaż w odwrotnej kolejności.

4.2 Wymiana panelu przedniego



WAŻNE

Ostre krawędzie obudowy!

Rany cięte

- ▶ Zawsze używaj rękawic ochronnych.



OSTRZEŻENIE

Możliwość wyślizgnięcia się przechylonego urządzenia!

Złamania kości / zmiżdżenia

- ▶ Zabezpieczyć urządzenia przed wyślizgnięciem.



WAŻNE

Niebezpieczeństwo spadnięcia części po wykręceniu śrub!

Zranienie przez spadające części.

- ▶ Zabezpieczyć część przed spadnięciem.



UWAGA!

Niebezpieczeństwo spadnięcia części po wykręceniu śrub!

Uszkodzenie innych części urządzenia albo pomieszczenia mieszkalnego, np. podłogi.

- ▶ Zabezpieczyć część przed spadnięciem.

Warunek:

- ✓ Urządzenie odłączone od źródła zasilania.
- ✓ Urządzenie jest odłączone od źródła wody.
- ✓ [Błat roboczy został zdemontowany. → 359](#)
- ✓ [Dozownik detergentu został wyjęty. → 361](#)

4.2.1 Demontaż panelu przedniego

1. Wykręcić śruby (1).
2. Zwolnić zatrzask (2, 3).

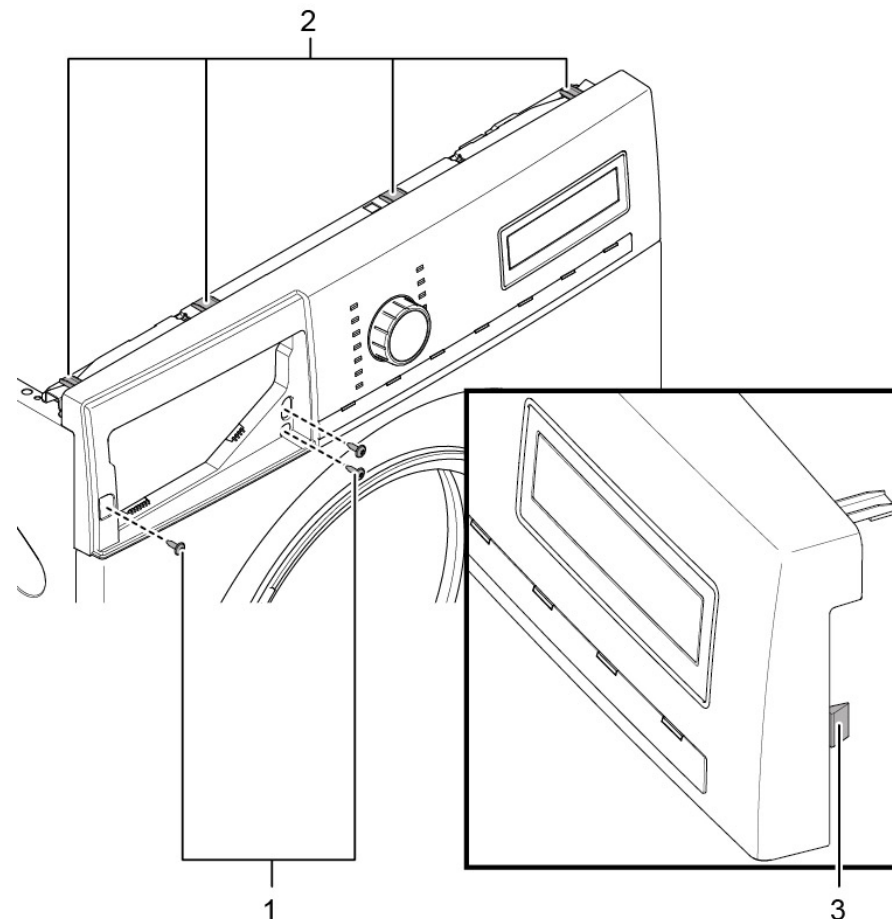

2. Odłączyć wtyk modułu sterującego.
3. Zdjąć panel przedni.

4.2.2 Montaż panelu przedniego

- ▶ Montaż w odwrotnej kolejności.

4.3 Wymiana dozownika detergentu

Warunek:

- ✔ Urządzenie odłączone od źródła zasilania.
- ✔ Urządzenie jest odłączone od źródła wody.

4.3.1 Demontaż dozownika detergentu

1. Wysunąć dozownik detergentu.
2. 1. Nacisnąć wsuwaną część do dołu (1).
2. Wyjąć dozownik detergentu (2).

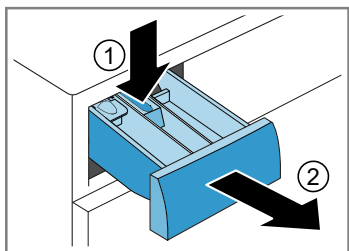

4.3.2 Montaż dozownika detergentu

- ▶ Montaż w odwrotnej kolejności.

4.4 Wymiana uchwyty dozownika detergentu

Warunek:

- ✔ Urządzenie odłączone od źródła zasilania.
- ✔ Urządzenie jest odłączone od źródła wody.
- ✔ [Dozownik detergentu został wyjęty. → 361](#)

4.4.1 Demontaż uchwyty dozownika detergentu

1. Zwolnić zatrzaski.

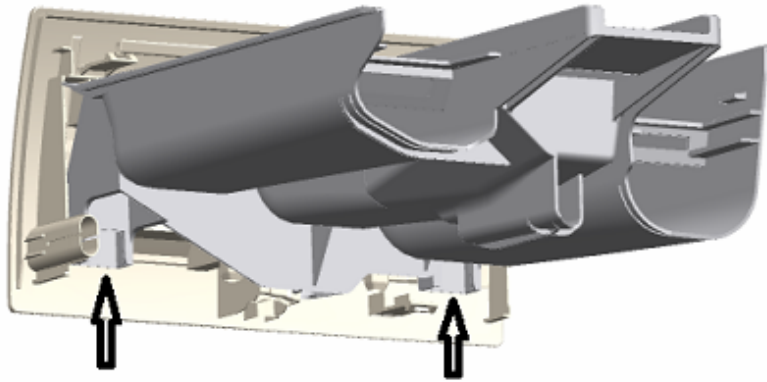

2. Wyjąć uchwyt dozownika detergentu.

4.4.2 Montaż uchwyty dozownika detergentu

- ▶ Montaż w odwrotnej kolejności.

4.5 Wymiana drzwi



WAŻNE

Odsłonięty zawias!

Zmiażdżenie / uwięzienie palca

- ▶ Nie wkładać rąk pod zawiasy.
- ▶ Zawsze używaj rękawic ochronnych.

Warunek:

- ✔ Urządzenie odłączone od źródła zasilania.
- ✔ Urządzenie jest odłączone od źródła wody.
- ✔ Drzwiczki są otwarte.

4.5.1 Demontaż drzwi

1.



UWAGA!

Niebezpieczeństwo spadnięcia części po wykręceniu śrub!

Uszkodzenie innych części urządzenia albo pomieszczenia mieszkalnego, np. podłogi.

- ▶ Zabezpieczyć część przed spadnięciem.



WAŻNE

Niebezpieczeństwo spadnięcia części po wykręceniu śrub!

Zranienie przez spadające części.

- ▶ Zabezpieczyć część przed spadnięciem.

Wykręcić śruby (1).

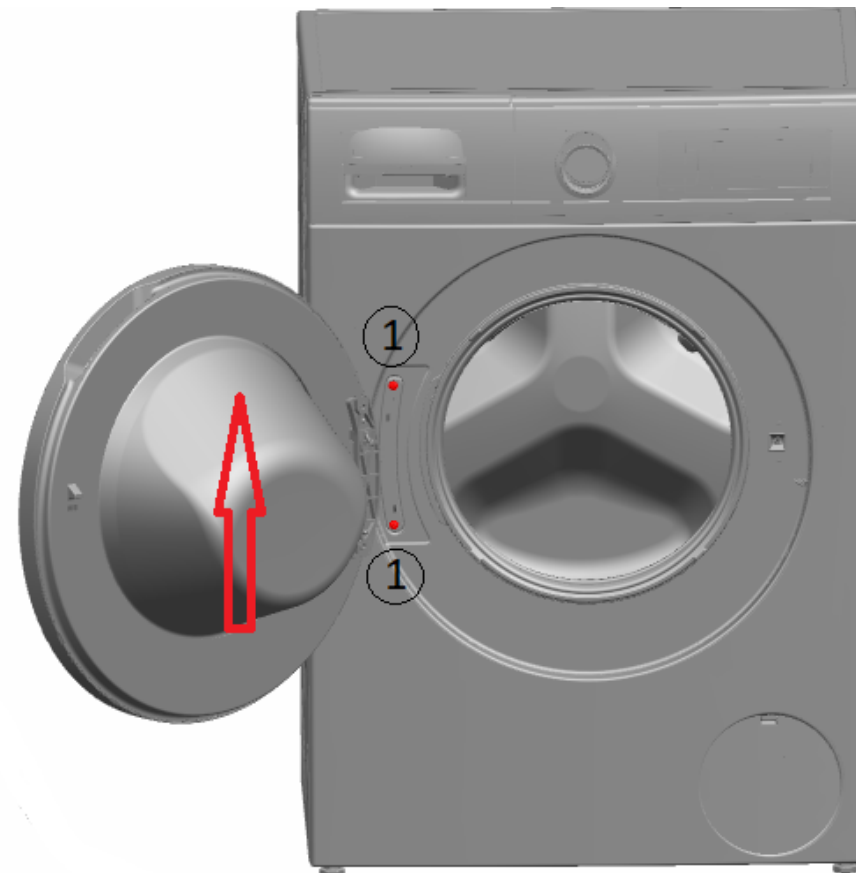

2. Wyjąć drzwiczki do góry.

4.5.2 Montaż drzwi

- ▶ Montaż w odwrotnej kolejności.

4.6 Wymiana komponentów drzwiczek



WAŻNE

Odsłonięty zawias!

Zmiażdżenie / uwięzienie palca

- ▶ Nie wkładać rąk pod zawiasy.
- ▶ Zawsze używaj rękawic ochronnych.

Warunek:

- ✔ Urządzenie odłączone od źródła zasilania.
- ✔ Urządzenie jest odłączone od źródła wody.
- ✔ [Drzwi zostały zdemontowane. →363](#)

4.6.1 Demontaż komponentów drzwiczek

- ▶ Zdemontować drzwiczki od zewnątrz do wewnątrz.

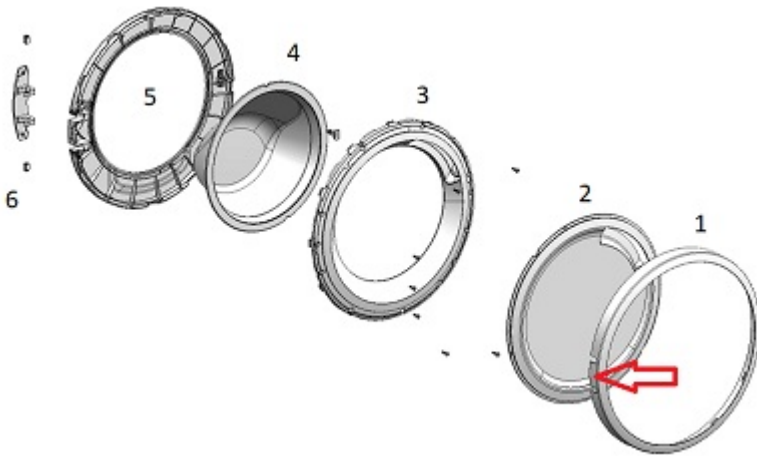

4.6.2 Montaż komponentów drzwiczek

- ▶ Montaż w odwrotnej kolejności.

4.7 Wymiana uszczelki drzwi



WAŻNE

Ostre krawędzie obudowy!

Rany cięte

- ▶ Zawsze używaj rękawic ochronnych.



WAŻNE

Niebezpieczeństwo spadnięcia części po wykręceniu śrub!

Zranienie przez spadające części.

- ▶ Zabezpieczyć część przed spadnięciem.



UWAGA!

Niebezpieczeństwo spadnięcia części po wykręceniu śrub!

Uszkodzenie innych części urządzenia albo pomieszczenia mieszkalnego, np. podłogi.

- ▶ Zabezpieczyć część przed spadnięciem.

Warunek:

- ✓ Urządzenie odłączone od źródła zasilania.
- ✓ Urządzenie jest odłączone od źródła wody.
- ✓ [Dozownik detergentu został wyjęty. → 361](#)
- ✓ [Drzwi zostały zdemontowane. → 363](#)
- ✓ [Pokrywa pompy została zdjęta. → 372](#)

4.7.1 Demontaż uszczelki drzwi

1.



OSTRZEŻENIE

Możliwość wyslizgnięcia się przechylonego urządzenia!

Złamania kości / zmiżdżenia

- ▶ Zabezpieczyć urządzenia przed wyslizgnięciem.

Podnieść przednią część urządzenia.

2. Wykręcić dolne śruby ściany przedniej (1).

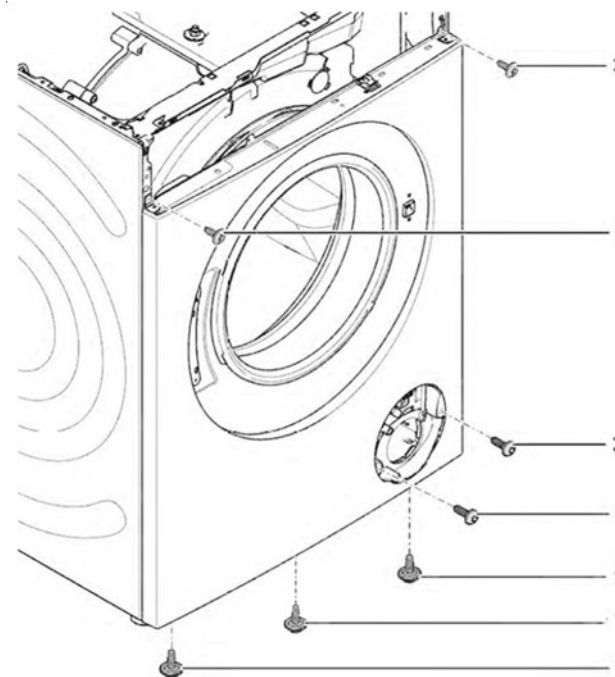

3. Opuścić urządzenie.

Naprawy

4. Wykręcić śruby w obszarze pompy (2).

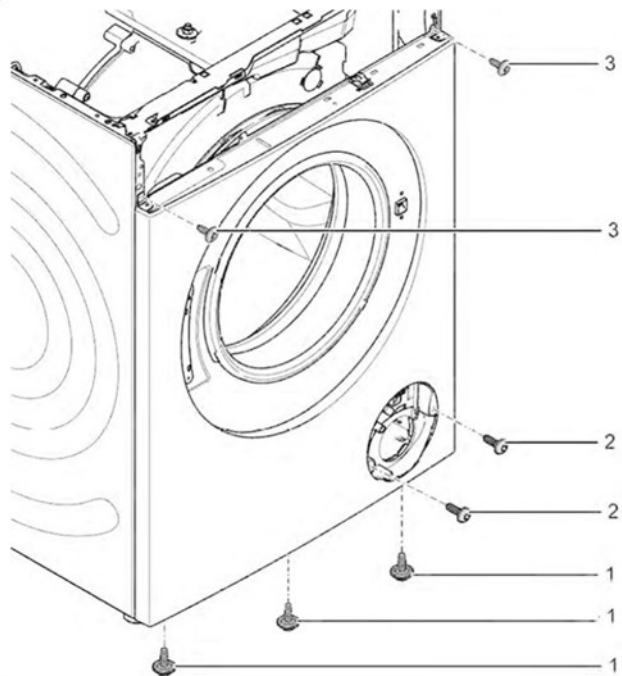

5. 1. Wykręcić śruby z tyłu urządzenia (1).
2. Zdjąć blat roboczy (2, 3).

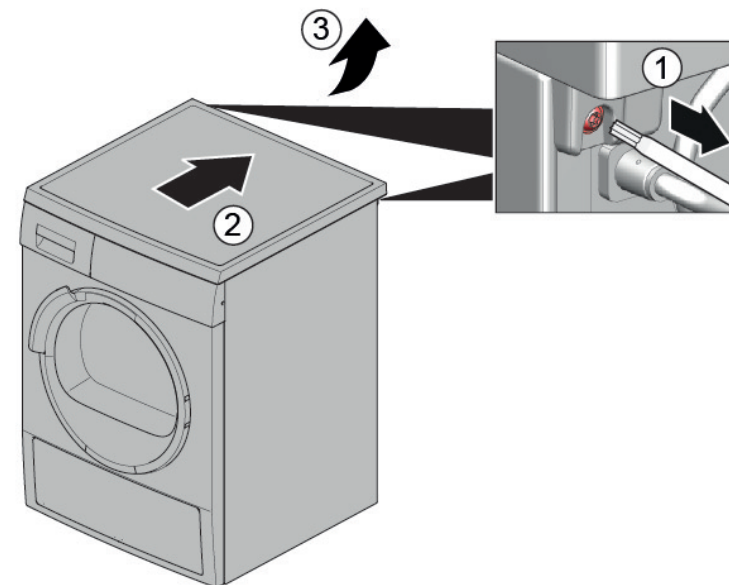

6. 1. Wykręcić śruby (1).
2. Zwolnić zatrzaski panelu przedniego (2, 3).
3. Wykręcić śruby obudowy dozownika.

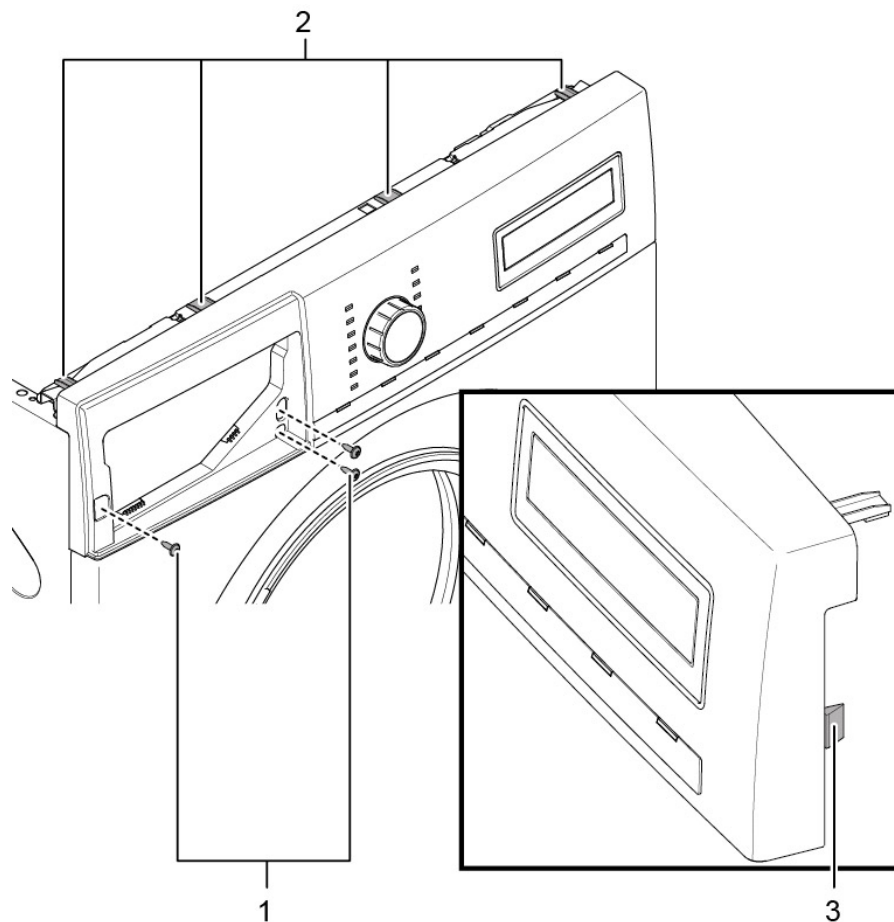

7. Zdjąć panel przedni.

8. Wyjąć górny uchwyt oświetlenia bębna.

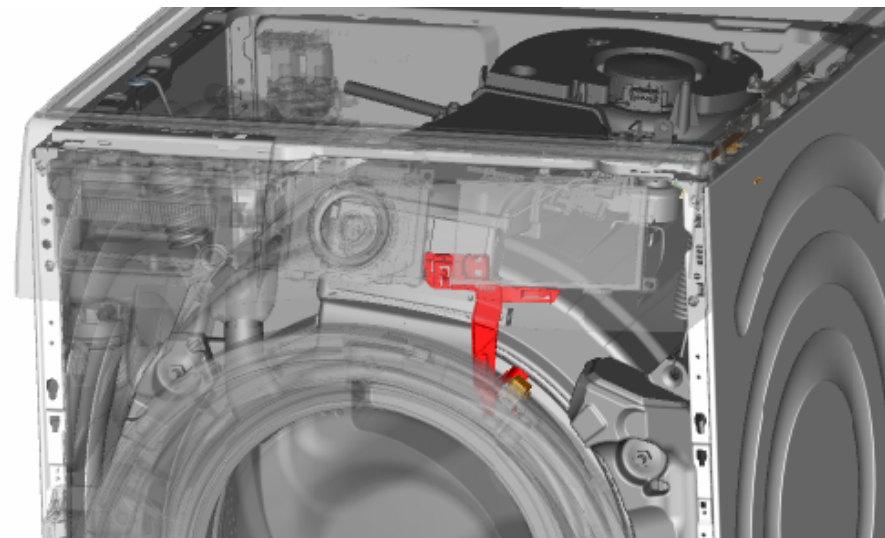

- 9.



UWAGA!

Niebezpieczeństwo uszkodzenia powierzchni!

Użycie nieodpowiednich narzędzi może porysować powierzchnię urządzenia.

- ▶ Do wymiany pierścienia naprężającego używać tylko plastikowych narzędzi.

Wyjąć pierścień naprężający z uszczelki, używając plastikowego narzędzia.

10. Wyjąć uszczelkę drzwiczek ze ściany przedniej.
11. Odłączyć złącze kabla od zamka drzwiczek.

12. Wykręcić górne śruby ściany przedniej (3).

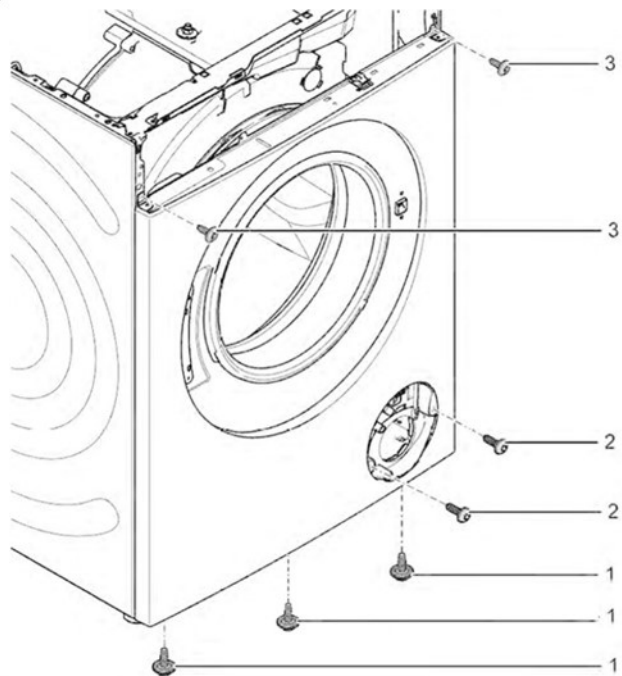

13. Zdjąć ścianę przednią.

14. Rozłączyć wszystkie połączenia węży.

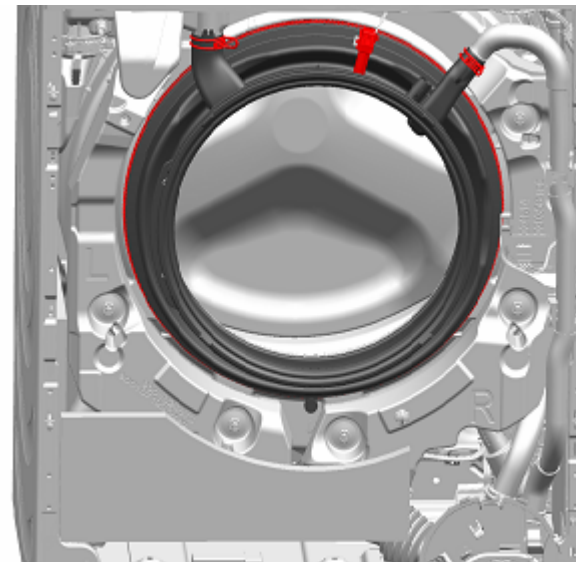

15. Wyjąć uszczelkę drzwiczek.

4.7.2 Montaż uszczelki drzwi



OSTRZEŻENIE

Niebezpieczeństwo spadnięcia części wskutek nieprawidłowego montażu!

Zranienie lub uszkodzenie urządzenia.

- ▶ Dokręcić pierścień naprężający uszczelki otworu pralki momentem obrotowym 3,4 Nm.

▶ Montaż w odwrotnej kolejności.

4.8 Wymiana blokady drzwi

Jako producent mamy zgodnie z rozporządzeniem (UE) 2019/2023 obowiązek udostępnienia klientowi zamka drzwiczek jako części zamiennej wraz z instrukcją naprawy. Informujemy jednak, że przed ponownym rozpoczęciem użytkowania urządzenia po wymianie drzwiczek konieczne jest przeprowadzenie testu bezpieczeństwa elektrotechnicznego przez wykwalifikowanego elektryka. Osoba ta musi posiadać kwalifikacje i uprawnienia wymagane zgodnie z ustawodawstwem, przepisami i normami kraju użytkowania.

	⚠ NIEBEZPIECZEŃSTWO
<p>Ryzyko porażenia prądem elektrycznym wskutek kontaktu z elementami znajdującymi się pod napięciem! Niebezpieczeństwo utraty życia wskutek porażenia prądem elektrycznym w przypadku nieprawidłowej naprawy</p> <ul style="list-style-type: none"> ▶ Części elektryczne powinny być naprawiane przez wykwalifikowanych elektryków. ▶ Po naprawie należy przeprowadzić test bezpieczeństwa zgodny z przepisami normy VDE 0701 (Niemcy) lub odpowiednimi przepisami obowiązującymi w kraju użytkowania. 	

	⚠ WAŻNE
<p>Ostre krawędzie obudowy! Rany cięte</p> <ul style="list-style-type: none"> ▶ Zawsze używaj rękawic ochronnych. 	

	⚠ OSTRZEŻENIE
<p>Możliwość wyslizgnięcia się przechylonego urządzenia! Złamania kości / zmiżdżenia</p> <ul style="list-style-type: none"> ▶ Zabezpieczyć urządzenia przed wyslizgnięciem. 	

	⚠ WAŻNE
<p>Niebezpieczeństwo spadnięcia części po wykręceniu śrub! Zranienie przez spadające części.</p> <ul style="list-style-type: none"> ▶ Zabezpieczyć część przed spadnięciem. 	

	UWAGA!
<p>Niebezpieczeństwo spadnięcia części po wykręceniu śrub! Uszkodzenie innych części urządzenia albo pomieszczenia mieszkalnego, np. podłogi.</p> <ul style="list-style-type: none"> ▶ Zabezpieczyć część przed spadnięciem. 	

Warunek:

- ✓ Urządzenie odłączone od źródła zasilania.
- ✓ Urządzenie jest odłączone od źródła wody.
- ✓ Urządzenie jest swobodnie dostępne.
- ✓ [Błat roboczy został zdemontowany. → 359](#)
- ✓ Panel przedni został zdemontowany.
- ✓ [Drzwi zostały zdemontowane. → 363](#)
- ✓ Pierścień naprężający został zdemontowany.
- ✓ Ściana przednia została zdemontowana.
- ✓ Została wyjęta uszczelka drzwiczek.

4.8.1 Demontaż blokady drzwi

1. Odłączyć wtyczkę zamka drzwiczek.
2. Zwolnić blokadę drzwi.



3. Wyjąć blokadę drzwi.

4.8.2 Montaż blokady drzwi

Blokada drzwiczek musi się znajdować w poprawnej pozycji w celu zapewnienia możliwości awaryjnego otwarcia drzwiczek urządzenia.

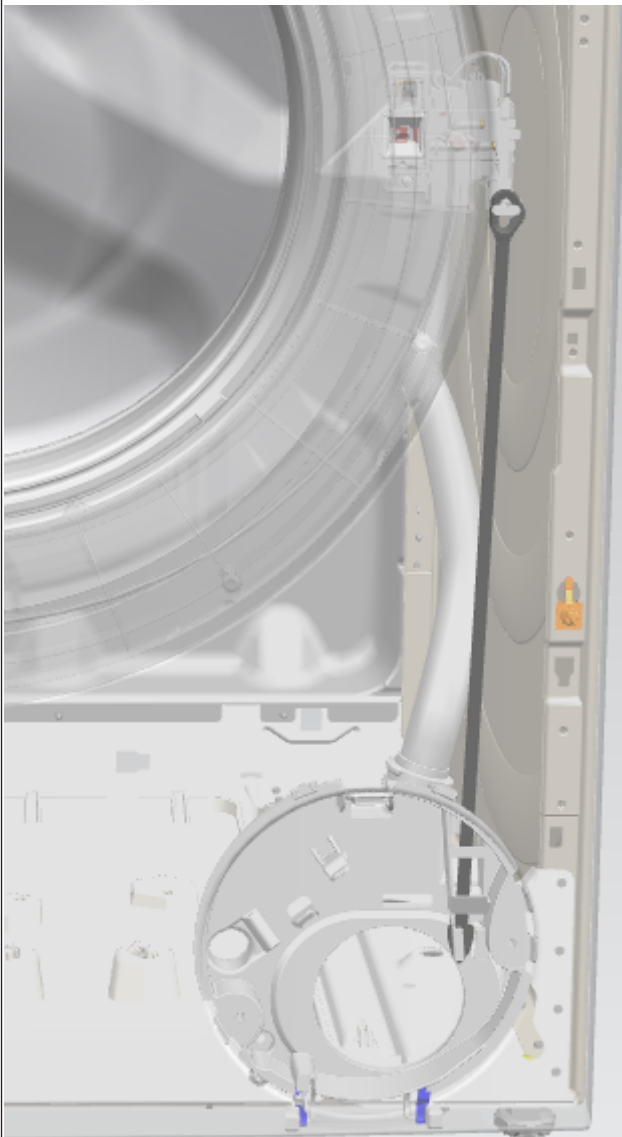

- ▶ Montaż w odwrotnej kolejności.

4.9 Wymiana oświetlenia bębna



WAŻNE

Ostre krawędzie obudowy!

Rany cięte

- ▶ Zawsze używaj rękawic ochronnych.



OSTRZEŻENIE

Możliwość wyślizgnięcia się przechylonego urządzenia!

Złamania kości / zmiżdżenia

- ▶ Zabezpieczyć urządzenia przed wyślizgnięciem.



WAŻNE

Niebezpieczeństwo spadnięcia części po wykręceniu śrub!

Zranienie przez spadające części.

- ▶ Zabezpieczyć część przed spadnięciem.



UWAGA!

Niebezpieczeństwo spadnięcia części po wykręceniu śrub!

Uszkodzenie innych części urządzenia albo pomieszczenia mieszkalnego, np. podłogi.

- ▶ Zabezpieczyć część przed spadnięciem.

Warunek:

- ✔ Urządzenie odłączone od źródła zasilania.
- ✔ Urządzenie jest odłączone od źródła wody.
- ✔ Urządzenie jest swobodnie dostępne.
- ✔ [Błat roboczy został zdemontowany. → 359](#)
- ✔ [Dozownik detergentu został wyjęty. → 361](#)
- ✔ Panel przedni został zdemontowany.

4.9.1 Demontaż oświetlenia bębna

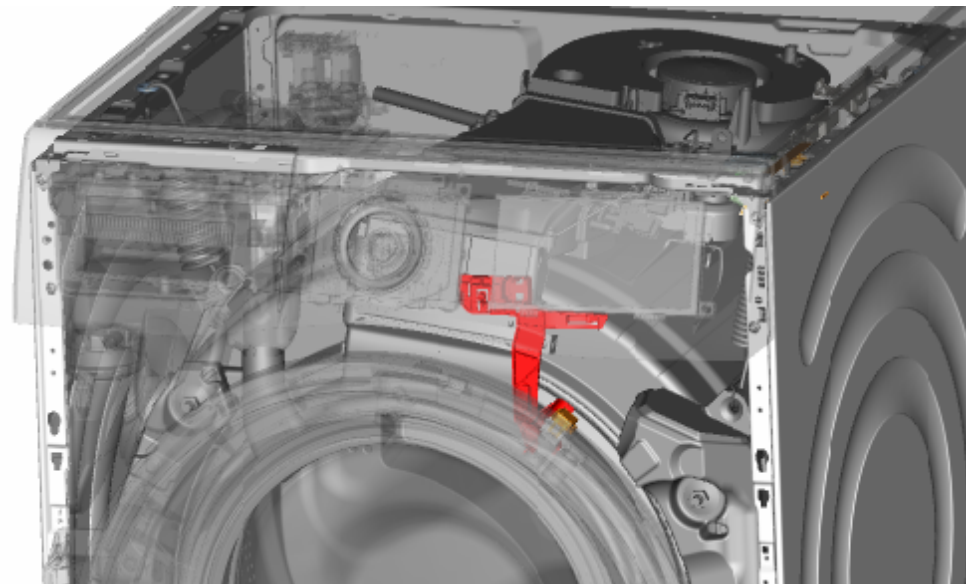

1. Wyciągnąć uchwyt oświetlenia bębna z urządzenia.
2. Rozłączyć złącza elektryczne.
3. Wyjąć oświetlenie bębna z uchwytu oświetlenia bębna.

4.9.2 Montaż oświetlenia bębna

- ▶ Montaż w odwrotnej kolejności.

4.10 Wymiana osłony pompy

Warunek:

- ✓ Urządzenie odłączone od źródła zasilania.
- ✓ Urządzenie jest odłączone od źródła wody.

4.10.1 Demontaż osłony pompy

1. Otworzyć osłonę pompy.

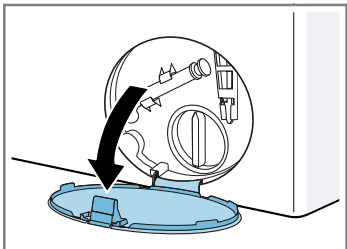

2. Zdjąć osłonę pompy.

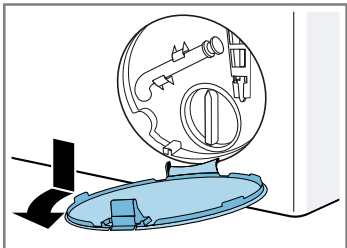

4.10.2 Montaż osłony pompy

- ▶ Montaż w odwrotnej kolejności.

4.11 Wymiana ściany przedniej



WAŻNE

Ostre krawędzie obudowy!

Rany cięte

- ▶ Zawsze używaj rękawic ochronnych.

Warunek:

- ✓ Urządzenie odłączone od źródła zasilania.
- ✓ Urządzenie jest odłączone od źródła wody.
- ✓ [Dozownik detergentu został wyjęty. → 361](#)
- ✓ [Drzwi zostały zdemontowane. → 363](#)
- ✓ Została wyjęta uszczelka drzwiczek.
- ✓ [Pokrywa pompy została zdjęta. → 372](#)

4.11.1 Demontaż ściany przedniej

1.



OSTRZEŻENIE

Możliwość wyslizgnięcia się przechylonego urządzenia!

Złamania kości / zmiżdżenia

- ▶ Zabezpieczyć urządzenia przed wyslizgnięciem.

Podnieść przednią część urządzenia.

2. Wykręcić dolne śruby (1).

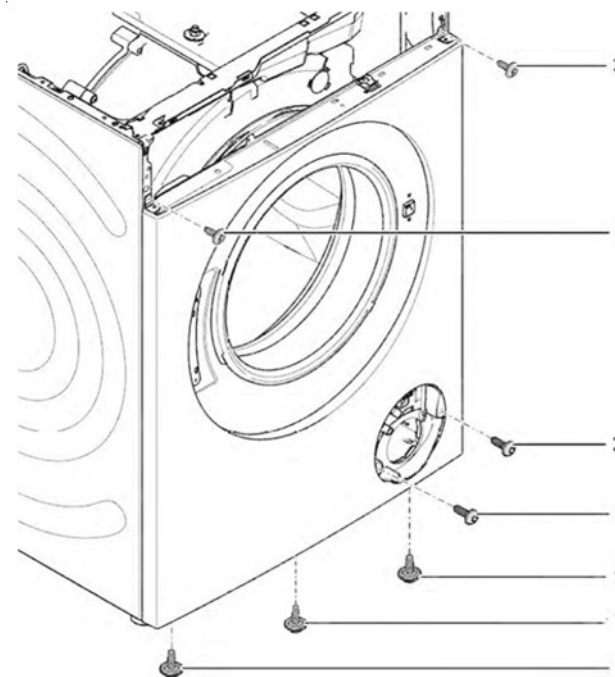

3. Opuścić urządzenie.

Naprawy

4. 1. Wykręcić śruby (1).
2. Przesunąć blat roboczy w stronę tyłu urządzenia (2).
3. Podnieść blat roboczy do góry (3), aby go zdjąć.

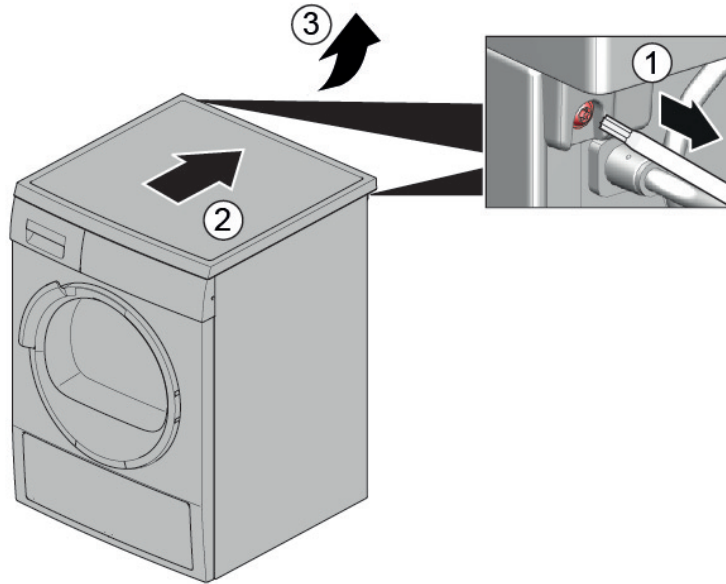

5. 1. Wykręcić śruby (1).
2. Zwolnić zatrzask (2, 3).

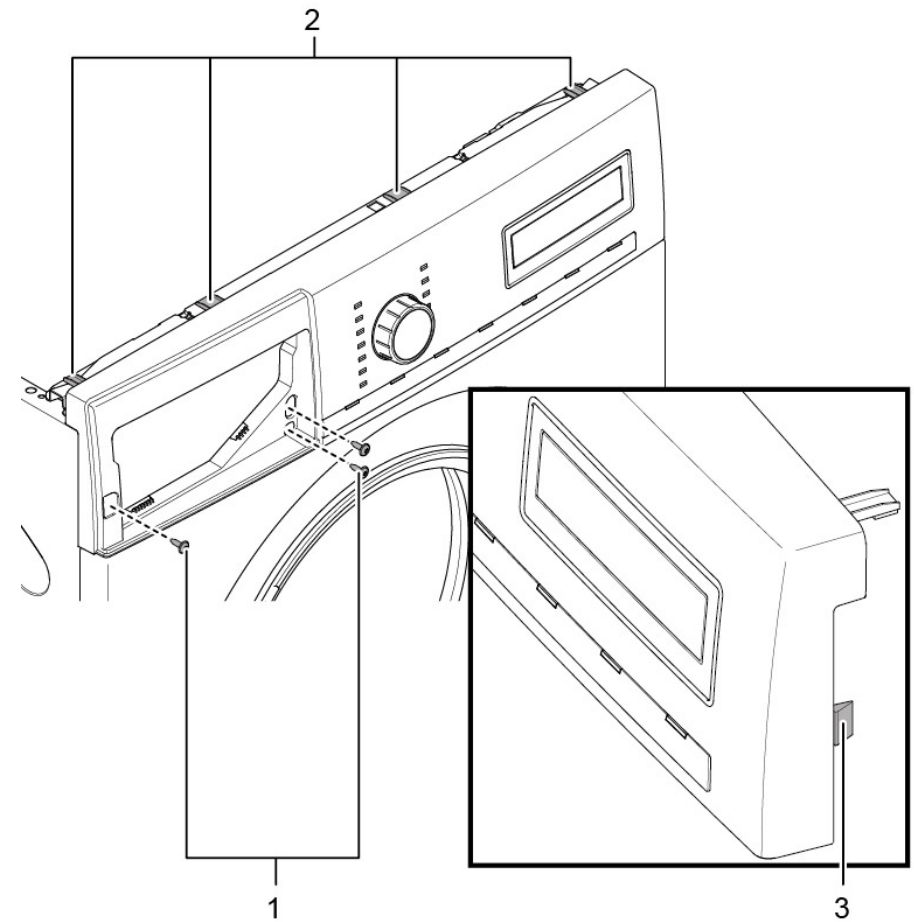

6. Zdjąć panel przedni.

7.



WAŻNE

Niebezpieczeństwo spadnięcia części po wykręceniu śrub!
Zranienie przez spadające części.
▶ Zabezpieczyć część przed spadnięciem.



UWAGA!

Niebezpieczeństwo spadnięcia części po wykręceniu śrub!

Uszkodzenie innych części urządzenia albo pomieszczenia mieszkalnego, np. podłogi.

- ▶ Zabezpieczyć część przed spadnięciem.

Wykręcić przednie śruby zaczynając od dołu i kończąc u góry (2, 3).

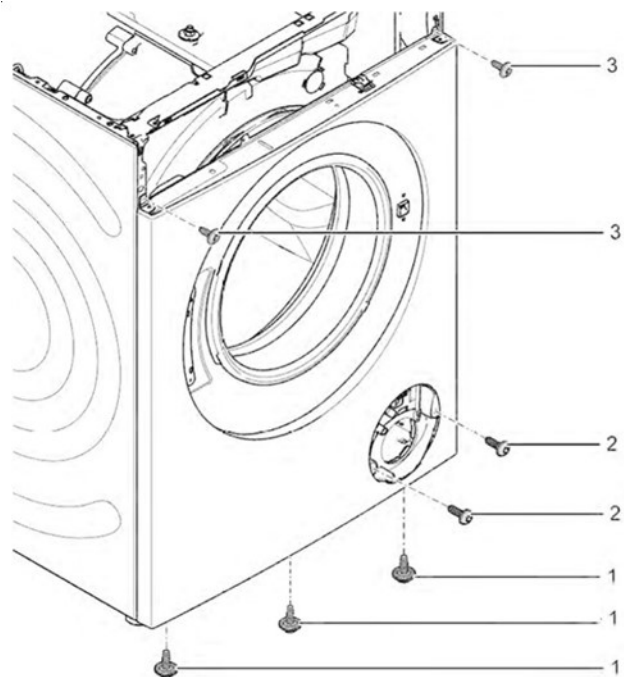

8. Zdjąć ścianę przednią.

4.11.2 Montaż ściany przedniej

- ▶ Montaż w odwrotnej kolejności.

Dicas de resolução - Máquina de lavar roupa

Sobre este documento..... 377

1.1	Informação importante.....	377
1.1.1	Finalidade.....	377
1.2	Explicação dos símbolos.....	377
1.2.1	Níveis de perigo.....	377
1.2.2	Símbolos de perigo.....	377
1.2.3	Estrutura dos avisos.....	378
1.2.4	Símbolos gerais.....	378

Segurança..... 379

2.1	Instruções gerais de segurança.....	379
2.1.1	Todos os eletrodomésticos.....	379

Ferramentas e auxiliares..... 380

Reparação..... 381

4.1	Substituir o tampo.....	381
4.1.1	Remover o tampo.....	381
4.1.2	Instalar o tampo.....	381
4.2	Substituir o painel dos comandos.....	382
4.2.1	Remover o painel dos comandos.....	382
4.2.2	Instalar o painel dos comandos.....	382
4.3	Substituir a gaveta para detergente.....	383
4.3.1	Remover a gaveta para detergente.....	383
4.3.2	Instalar a gaveta para detergente.....	383
4.4	Substituir a pega da gaveta para detergente.....	384
4.4.1	Remover a pega da gaveta para detergente.....	384
4.4.2	Instalar a pega da gaveta para detergente.....	384
4.5	Substituir a porta.....	385
4.5.1	Remover a porta.....	385
4.5.2	Instalar a porta.....	385
4.6	Substituir os componentes da porta.....	386
4.6.1	Remover os componentes da porta.....	386
4.6.2	Instalar os componentes da porta.....	386
4.7	Substituir a vedação da porta.....	387
4.7.1	Remover a vedação da porta.....	387
4.7.2	Instalar a vedação da porta.....	390

4.8	Substituir o dispositivo de bloqueio da porta.....	391
4.8.1	Remover o dispositivo de bloqueio da porta.....	391
4.8.2	Instalar o dispositivo de bloqueio da porta.....	392
4.9	Substituir a luz do tambor.....	393
4.9.1	Remover a luz do tambor.....	393
4.9.2	Instalar a luz do tambor.....	393
4.10	Substituir a tampa da bomba.....	394
4.10.1	Remover a tampa da bomba.....	394
4.10.2	Instalar a tampa da bomba.....	394
4.11	Substituir o painel frontal.....	395
4.11.1	Remover o painel frontal.....	395
4.11.2	Instalar o painel frontal.....	397

i Sobre este documento

1.1 Informação importante

1.1.1 Finalidade

Estas dicas de reparação auxiliam o consumidor na reparação de aparelhos por ele próprio de acordo com o regulamento de "Eco-design" aplicável (a partir de 03/2021).

Estas contêm informações sobre como substituir peças sobressalentes definidas, incluindo avisos e riscos.

Em caso de dúvidas, entre em contacto com o nosso serviço de apoio ao cliente. Apenas nos responsabilizaremos por danos se as dicas de reparação tiverem sido devidamente seguidas.

1.2 Explicação dos símbolos

1.2.1 Níveis de perigo

Os níveis de aviso são compostos por um símbolo e uma palavra sinal. A palavra-sinal indica a gravidade do perigo.







Nível de aviso	Significado
 PERIGO	A não observância da mensagem de aviso resulta em morte ou ferimentos graves.
 AVISO	A não observância da mensagem de aviso pode resultar em morte ou ferimentos graves.
 CUIDADO	A não observância da mensagem de aviso pode resultar em ferimentos ligeiros.
ATENÇÃO!	A não observância da mensagem de aviso pode resultar em danos materiais.

Tabela 1: Níveis de perigo

1.2.2 Símbolos de perigo

Os símbolos de perigo são representações simbólicas que dão uma indicação do tipo de perigo.

Neste documento são utilizados os seguintes símbolos de perigo:

Símbolo de perigo	Significado
	Mensagem geral de aviso
	Perigo de tensão elétrica
	Risco de explosão
	Perigo de cortes

i Sobre este documento





Símbolo de perigo	Significado
	Perigo de esmagamento
	Perigo de superfícies quentes
	Perigo de campo eletromagnético intenso
	Perigo de radiação não-ionizante

Tabela 2: Símbolos de perigo

1.2.3 Estrutura dos avisos

Os avisos neste documento possuem um aspeto normalizado e uma estrutura normalizada.

	⚠ PERIGO
Tipo e origem do perigo!	
Possíveis consequência de ignorar o perigo / aviso.	
▶ Medidas e proibições para prevenir o perigo.	

O seguinte exemplo mostra um aviso que adverte contra choques elétricos devido a partes sob tensão. A medida para evitar o perigo é mencionada.

	⚠ PERIGO
Risco de choque elétrico devido a partes sob tensão!	
Morte por eletrocussão	
▶ Desligue os aparelhos da alimentação elétrica pelo menos 60 segundos antes de iniciar as reparações.	

1.2.4 Símbolos gerais

Neste documento são utilizados os seguintes símbolos gerais:







Símbolo ger.	Significado
	Identificação de uma dica especial (texto e/ou ilustração)
	Identificação de uma dica simples (apenas texto)
	Identificação de uma ligação para um tutorial em vídeo
	Identificação das ferramentas necessárias
	Identificação das condições prévias necessárias
	Identificação de uma condição (se ..., então ...)
	Identificação de um resultado
Iniciar	Identificação de uma tecla ou botão
[00123456]	Identificação de um número de material
Estado	Identificação de um texto exibido / janela (no visor do aparelho)

Tabela 3: Símbolos gerais

2.1 Instruções gerais de segurança

2.1.1 Todos os eletrodomésticos

Risco de choque elétrico devido a partes sob tensão!

- Erros por reparações envolvendo componentes elétricos podem provocar choques elétricos!
- Desligue o aparelho da rede elétrica pelo menos 60 segundos antes de iniciar o trabalho.
- Após a reparação, solicite a realização de um teste de segurança de acordo com VDE 0701 ou os regulamentos específicos do país.

Risco de ferimentos causados por arestas vivas!

- Use luvas de proteção.

Risco de esmagamento durante trabalhos de reparação, manutenção, resolução de problemas e serviço devido a componentes pesados e móveis

- Use calçado de proteção.
- Proteja os componentes pesados contra quedas.
- Não introduzir partes do corpo em componentes móveis.







Risco para a segurança/funcionamento do aparelho!

- Utilize apenas peças sobressalentes originais.

Risco de danos em componentes electrostaticamente sensíveis (ESDs)!

- Não toque nos módulos, incluindo ligações e percursos condutores.

Ferramentas e auxiliares

Designação	Detalhes	Imagens
Ferramenta auxiliar [15000155]	Ferramenta para soltar as partes em plástico	
Chave parafusos Torx T20 com orifício [00340764]	100 mm, para parafusos com pino de segurança	
Chave dinamométrica [15000441]	Chave dinamométrica 20 - 100 Nm	
Chave de fenda [00340854]	Lâmina 3,5 mm x 0,6 mm x 100 mm, isolamento protetor 1000 V AC	
Chave de fenda [00340855]	Lâmina 5,5 mm x 1,0 mm x 125 mm, isolamento protetor 1000 V AC	
Alicate de pontas, padrão angular [00341269]	Comprimento 200 mm	
Alicate de corte [00342182]	Comprimento: 200 mm	



Designação	Detalhes	Imagens
Chave combinada [00340811]	Tamanho da chave 10ºmm, M6	
Combination wrench [00340814]	Tamanho da chave 13ºmm, M8	
Chave combinada [00340817]	Tamanho da chave 17 mm, M10	
Chave combinada [15000459]	Tamanho da chave 16ºmm, M10	

4.1 Substituir o tampo

Ferramentas necessárias:

-  Ponta Torx TX20 com orifício, 6,3mm (1/4") 152ºmm, para parafusos com pino de segurança [00341272] longa

Pré-requisito:

-  O aparelho está desligado da energia.
-  O aparelho está desligado do abastecimento de água.

4.1.1 Remover o tampo

- ▶ 1. Remova os parafusos (1).
- ▶ 2. Empurre o tampo para a parte de trás do aparelho (2).
- ▶ 3. Mova o tampo para cima (3) para removê-lo.

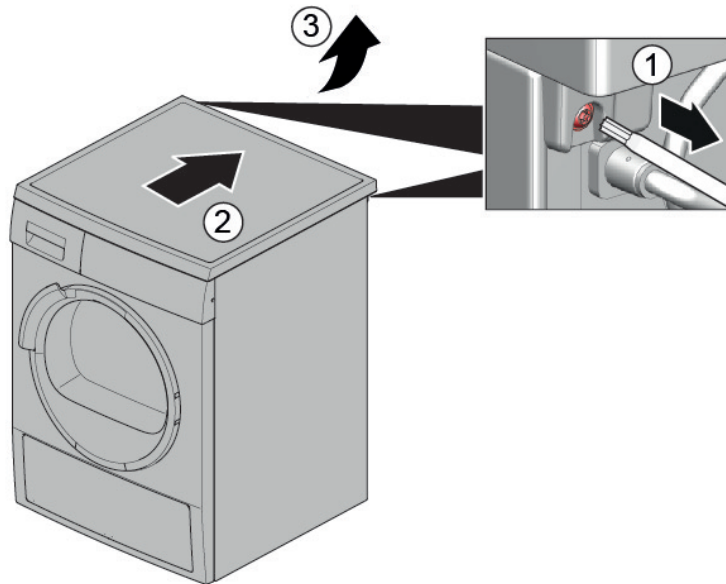



4.1.2 Instalar o tampo

- ▶ Instale pela ordem inversa.

4.2 Substituir o painel dos comandos

	⚠ CUIDADO Arestas vivas no alojamento! Lesões por corte ▶ Use luvas de proteção.
--	---

	⚠ AVISO Deslizamento de aparelhos inclinados! Fraturas ósseas / ferimentos de esmagamento ▶ Proteja os aparelhos contra o deslizamento.
--	--

	⚠ CUIDADO Risco de queda de peças devido a parafusos desapertados! Lesões devido à queda de peças. ▶ Proteja o componente contra as quedas.
--	--

	⚠ ATENÇÃO! Risco de queda de peças devido a parafusos desapertados! Danos em outros componentes do aparelho ou na casa do cliente, p. ex., no pavimento. ▶ Proteja o componente contra as quedas.
--	--

Pré-requisito:

- ✔ O aparelho está desligado da energia.
- ✔ O aparelho está desligado do abastecimento de água.
- ✔ [O tampo foi removido.→381](#)
- ✔ [A gaveta para detergente foi removida.→383](#)

4.2.1 Remover o painel dos comandos

1. Remova os parafusos (1).
2. Solte os elementos de encaixe (2, 3).

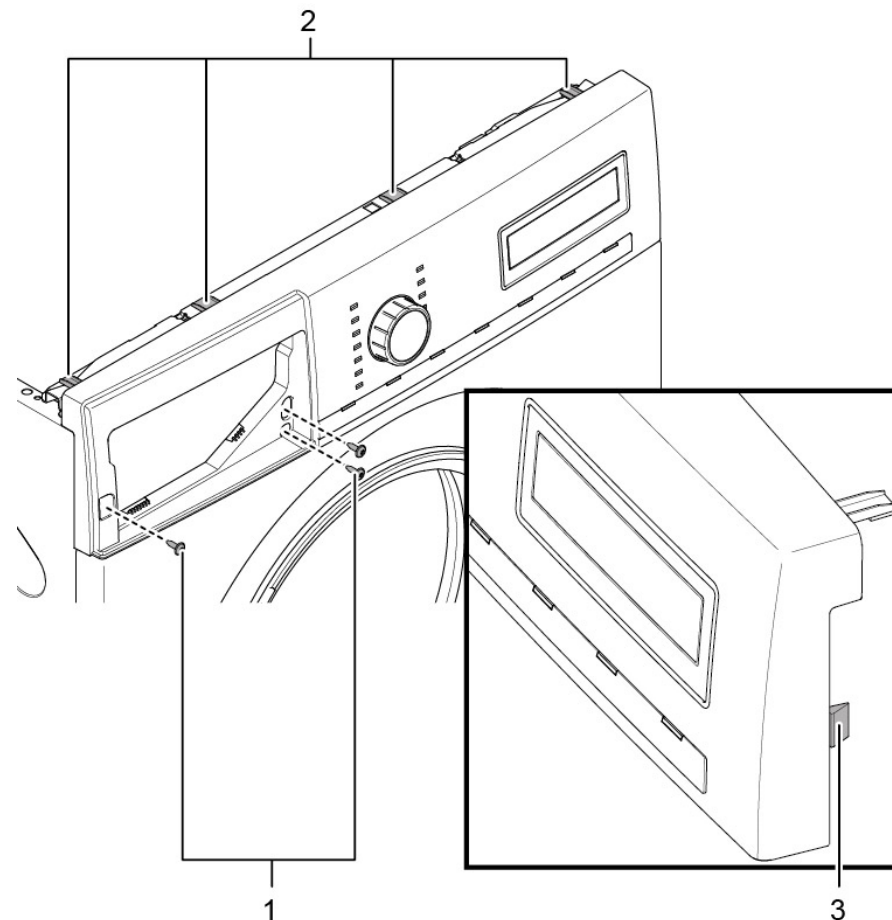

2. Solte o contacto de ligação da unidade de controlo.
3. Remova o painel dos comandos.

4.2.2 Instalar o painel dos comandos

- ▶ Instale pela ordem inversa.

4.3 Substituir a gaveta para detergente

Pré-requisito:

- ✓ O aparelho está desligado da energia.
- ✓ O aparelho está desligado do abastecimento de água.

4.3.1 Remover a gaveta para detergente

1. Puxe a gaveta para detergente para fora.
2. 1. Pressione para baixo ao inserir (1).
2. Remova a gaveta para detergente (2).

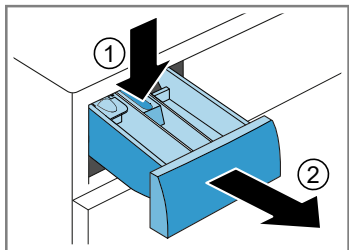

4.3.2 Instalar a gaveta para detergente

- ▶ Instale pela ordem inversa.

4.4 Substituir a pega da gaveta para detergente

Pré-requisito:

- ✓ O aparelho está desligado da energia.
- ✓ O aparelho está desligado do abastecimento de água.
- ✓ [A gaveta para detergente foi removida.→383](#)

4.4.1 Remover a pega da gaveta para detergente

1. Solte os elementos de encaixe.

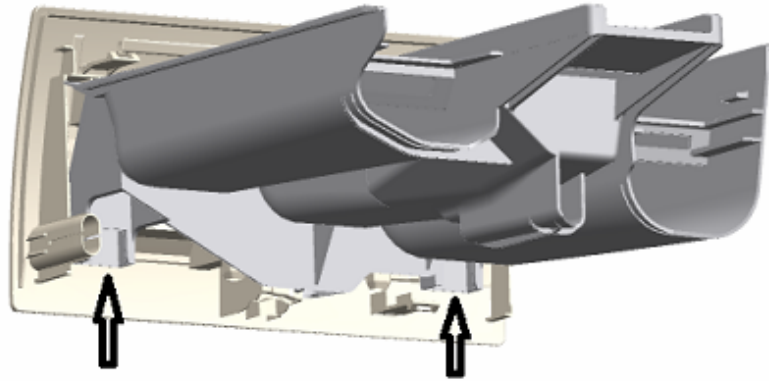

2. Remova a pega da gaveta para detergente.

4.4.2 Instalar a pega da gaveta para detergente

- ▶ Instale pela ordem inversa.

4.5 Substituir a porta

	⚠️ CUIDADO Zona das dobradiças aberta! Esmagamento / entalamento dos dedos <ul style="list-style-type: none">▶ Não coloque as mãos na zona das dobradiças.▶ Use luvas de proteção.
--	---

Pré-requisito:

- ✔ O aparelho está desligado da energia.
- ✔ O aparelho está desligado do abastecimento de água.
- ✔ A porta está aberta.

4.5.1 Remover a porta

1.

	ATENÇÃO! Risco de queda de peças devido a parafusos desapertados! Danos em outros componentes do aparelho ou na casa do cliente, p. ex., no pavimento. <ul style="list-style-type: none">▶ Proteja o componente contra as quedas.
---	---

	⚠️ CUIDADO Risco de queda de peças devido a parafusos desapertados! Lesões devido à queda de peças. <ul style="list-style-type: none">▶ Proteja o componente contra as quedas.
---	--

Remova os parafusos (1).

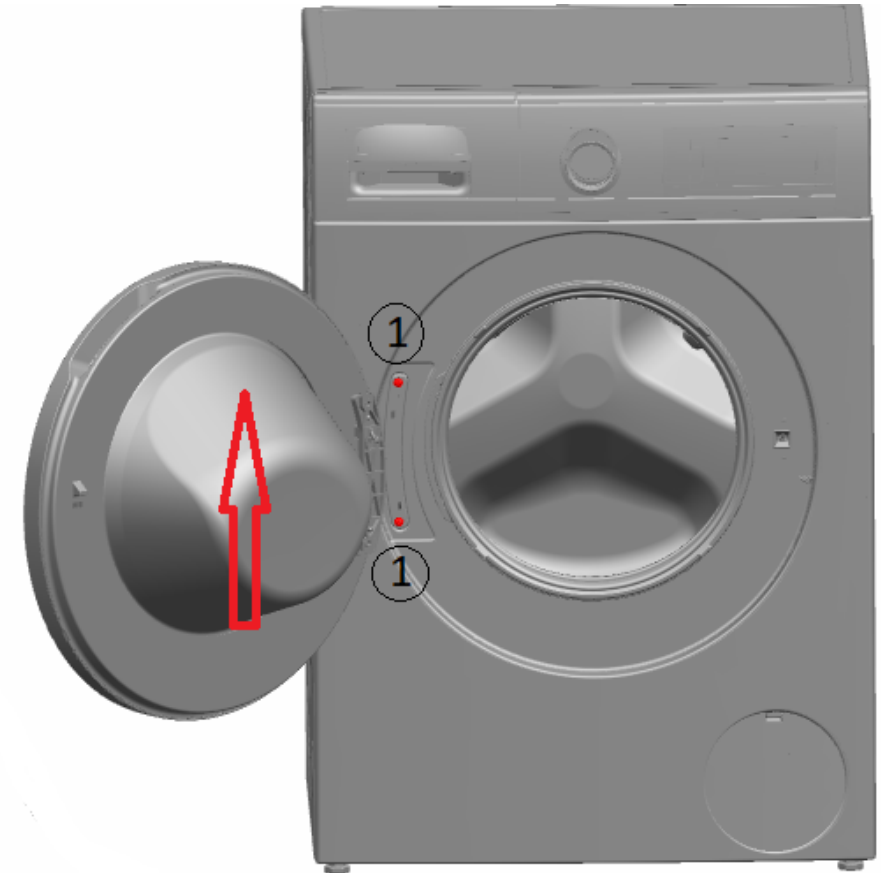

2. Remova a porta para cima.

4.5.2 Instalar a porta

- ▶ Instale pela ordem inversa.

4.6 Substituir os componentes da porta



CUIDADO

Zona das dobradiças aberta!

Esmagamento / entalamento dos dedos

- ▶ Não coloque as mãos na zona das dobradiças.
- ▶ Use luvas de proteção.

Pré-requisito:

- ✔ O aparelho está desligado da energia.
- ✔ O aparelho está desligado do abastecimento de água.
- ✔ [A porta foi removida. → 385](#)

4.6.1 Remover os componentes da porta

- ▶ Desmonte a porta do exterior para o interior.

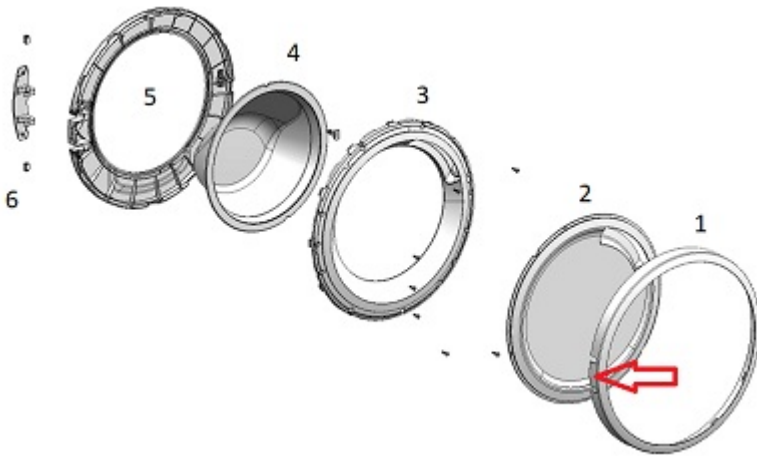

4.6.2 Instalar os componentes da porta

- ▶ Instale pela ordem inversa.

4.7 Substituir a vedação da porta



⚠️ CUIDADO

Arestas vivas no alojamento!
Lesões por corte
▶ Use luvas de proteção.



⚠️ CUIDADO

Risco de queda de peças devido a parafusos desapertados!
Lesões devido à queda de peças.
▶ Proteja o componente contra as quedas.



⚠️ ATENÇÃO!

Risco de queda de peças devido a parafusos desapertados!
Danos em outros componentes do aparelho ou na casa do cliente, p. ex., no pavimento.
▶ Proteja o componente contra as quedas.

Pré-requisito:

- ✓ O aparelho está desligado da energia.
- ✓ O aparelho está desligado do abastecimento de água.
- ✓ [A gaveta para detergente foi removida. → 383](#)
- ✓ [A porta foi removida. → 385](#)
- ✓ [A tampa da bomba foi removida. → 394](#)

4.7.1 Remover a vedação da porta

1.



⚠️ AVISO

Deslizamento de aparelhos inclinados!
Fraturas ósseas / ferimentos de esmagamento
▶ Proteja os aparelhos contra o deslizamento.

Levante o aparelho na parte da frente.

2. Solte os parafusos na parte inferior do painel frontal (1).

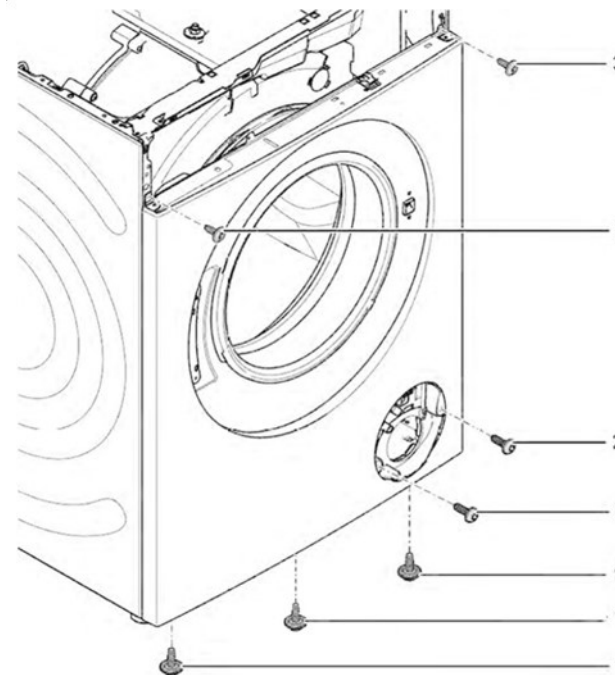

3. Baixe o aparelho.

Reparação

4. Remova os parafusos na zona da bomba (2).

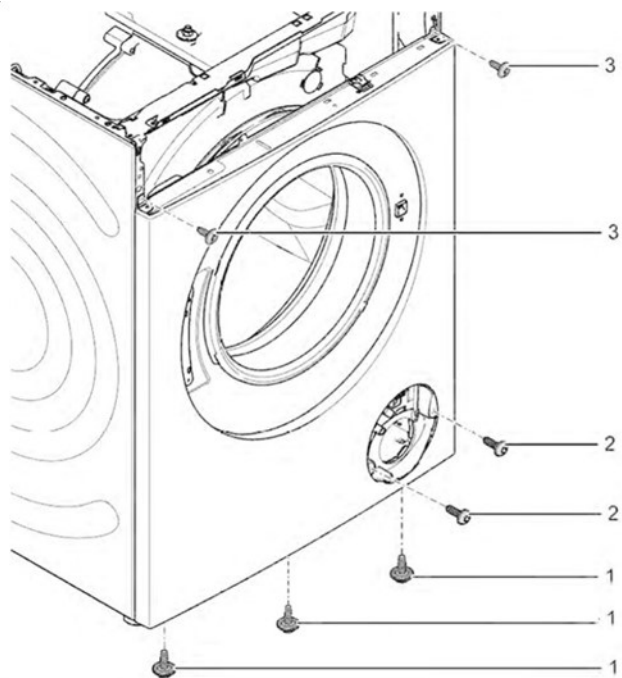

5. 1. Solte os parafusos na parte de trás do aparelho (1).
2. Remova o tampo (2, 3).

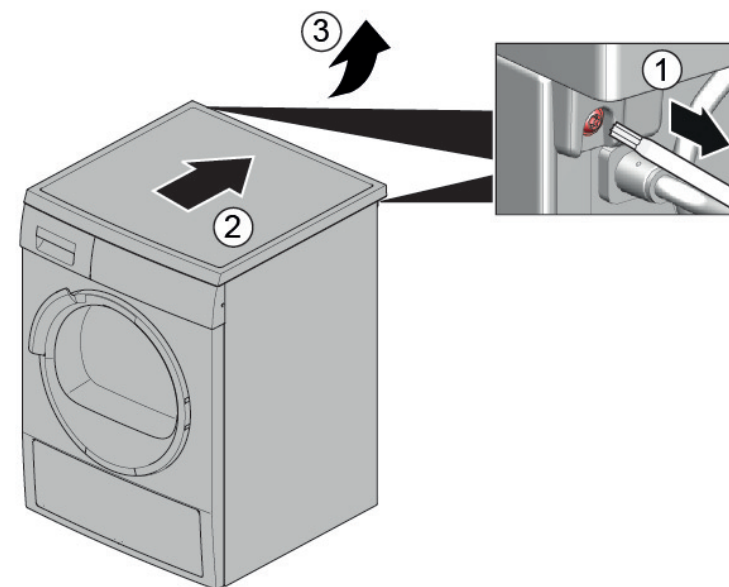

Reparação

6. 1. Remova os parafusos (1).
2. Solte os elementos de encaixe do painel da fachada (2, 3).
3. Solte os parafusos do invólucro do dispensador.

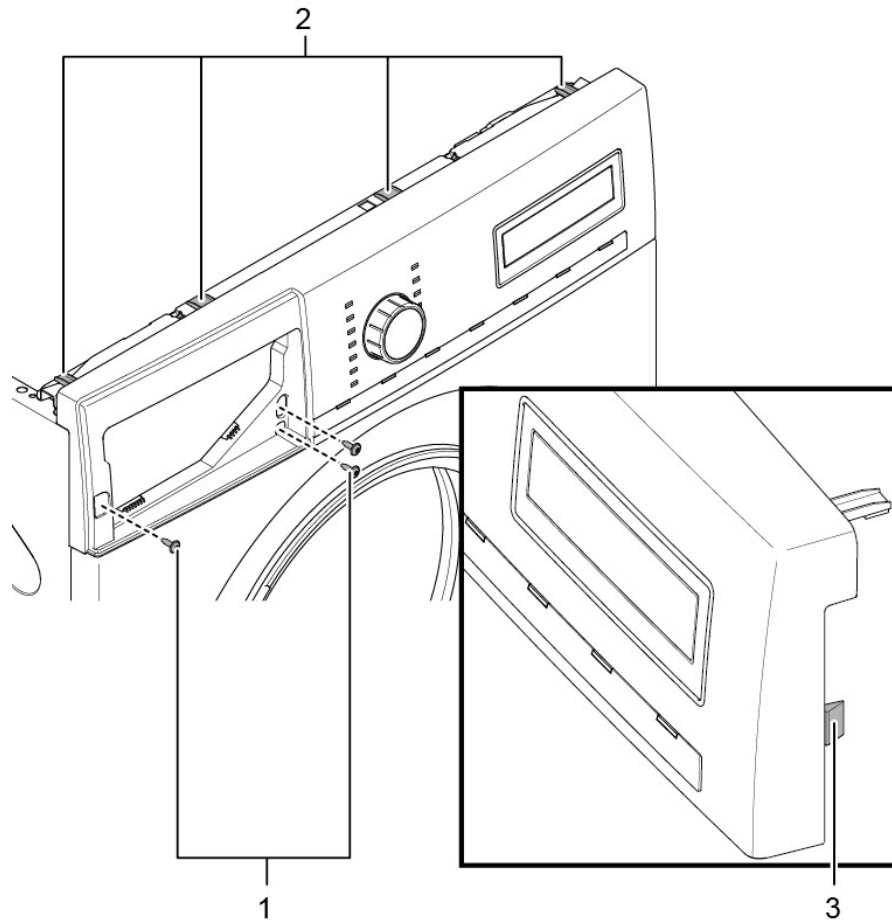

7. Remova o painel da fachada.

8. Remova o suporte da luz do tambor na parte superior.

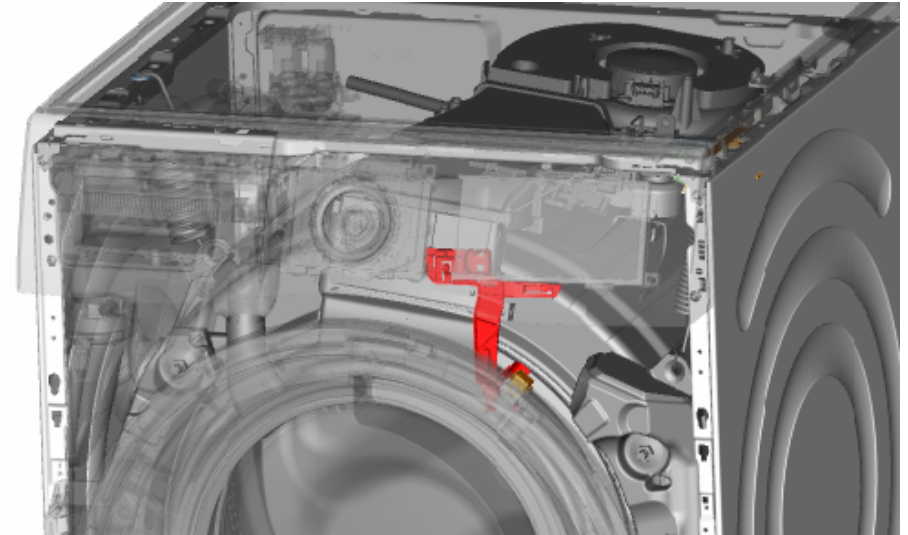

- 9.



ATENÇÃO!

Risco de superfície danificada!

A superfície do aparelho pode ficar riscada devido ao uso das ferramentas erradas.

- ▶ Utilize exclusivamente ferramentas de plástico para substituir o anel de tensão.

Remova o anel de tensão da junta com uma ferramenta de plástico.

10. Solte a vedação da porta do painel frontal.
11. Solte o conector do cabo do dispositivo de bloqueio da porta.

12. Solte os parafusos na parte superior do painel frontal (3).

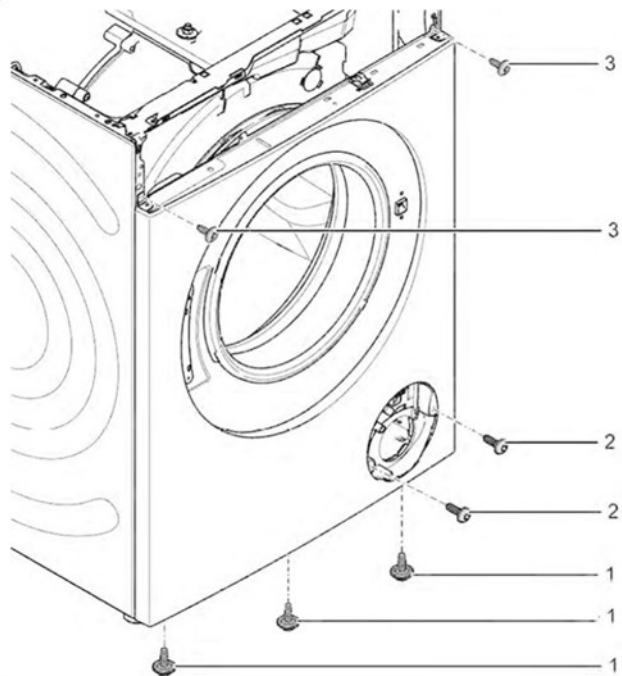

13. Remova o painel frontal.

14. Solte todas as ligações de mangueiras.

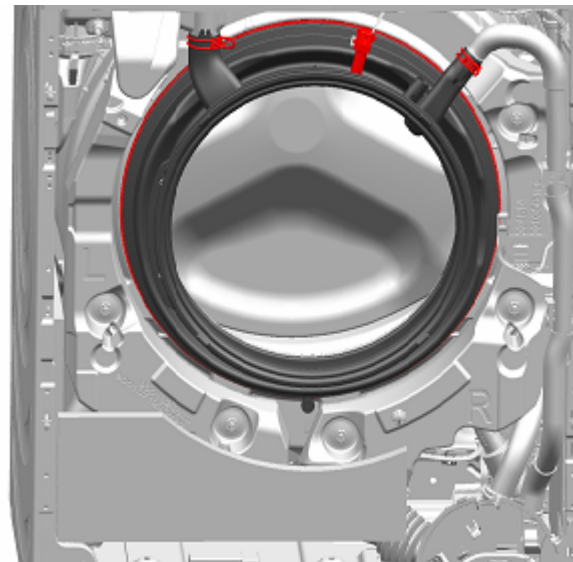

15. Remova a vedação da porta.

4.7.2 Instalar a vedação da porta



AVISO

Risco de queda de peças devido a instalação incorreta!

Ferimentos ou danos no aparelho.

▶ Aperte o anel de tensão da borracha do óculo com 3,4 Nm.

▶ Instale pela ordem inversa.

4.8 Substituir o dispositivo de bloqueio da porta

Na qualidade de fabricante, somos obrigados a fornecer aos consumidores um dispositivo de bloqueio da porta sobressalente incluindo as instruções de reparação de acordo com o Regulamento (UE) 2019/2023. Contudo, gostaríamos de salientar que após a substituição de um dispositivo de bloqueio da porta, é necessário um teste de segurança eletrotécnica realizado por um profissional qualificado antes de colocar o dispositivo em funcionamento. Tem de ser possível verificar a qualificação da pessoa em questão de acordo com as leis, regulamentos e normas específicas do país.

	<p>⚠ PERIGO</p> <p>Risco de choque elétrico devido a partes sob tensão! Risco de vida devido a choque elétrico em caso de reparação inadequada</p> <ul style="list-style-type: none">▶ As partes elétricas devem ser reparadas por um electricista qualificado.▶ Após a reparação, solicite a realização de um teste de segurança de acordo com VDE 0701 ou os regulamentos específicos do país.
--	---

	<p>⚠ CUIDADO</p> <p>Arestas vivas no alojamento! Lesões por corte</p> <ul style="list-style-type: none">▶ Use luvas de proteção.
--	--

	<p>⚠ AVISO</p> <p>Deslizamento de aparelhos inclinados! Fraturas ósseas / ferimentos de esmagamento</p> <ul style="list-style-type: none">▶ Proteja os aparelhos contra o deslizamento.
---	---

	<p>⚠ CUIDADO</p> <p>Risco de queda de peças devido a parafusos desapertados! Lesões devido à queda de peças.</p> <ul style="list-style-type: none">▶ Proteja o componente contra as quedas.
--	---

	<p>ATENÇÃO!</p> <p>Risco de queda de peças devido a parafusos desapertados! Danos em outros componentes do aparelho ou na casa do cliente, p. ex., no pavimento.</p> <ul style="list-style-type: none">▶ Proteja o componente contra as quedas.
--	---

Pré-requisito:

- ✓ O aparelho está desligado da energia.
- ✓ O aparelho está desligado do abastecimento de água.
- ✓ O aparelho está livremente acessível.
- ✓ [O tampo foi removido.→381](#)
- ✓ O painel da fachada foi removido.
- ✓ [A porta foi removida.→385](#)
- ✓ O anel de tensão foi removido.
- ✓ O painel frontal foi removido.
- ✓ A vedação da porta foi removida.

4.8.1 Remover o dispositivo de bloqueio da porta

1. Desligue a ficha do dispositivo de bloqueio da porta.
2. Solte o dispositivo de bloqueio da porta.



3. Remova o dispositivo de bloqueio da porta.



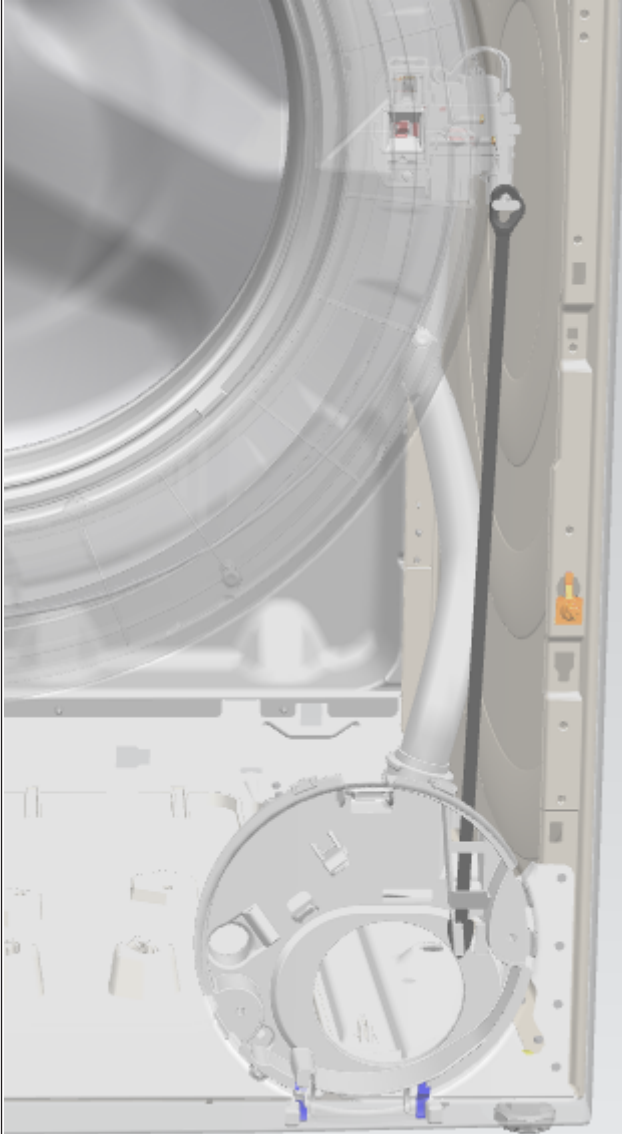

4.8.2 Instalar o dispositivo de bloqueio da porta

O dispositivo de bloqueio da porta deve estar na posição correta para garantir a função de abertura de emergência da porta do aparelho.



- ▶ Instale pela ordem inversa.

4.9 Substituir a luz do tambor

	⚠ CUIDADO Arestas vivas no alojamento! Lesões por corte ▶ Use luvas de proteção.
	⚠ AVISO Deslizamento de aparelhos inclinados! Fraturas ósseas / ferimentos de esmagamento ▶ Proteja os aparelhos contra o deslizamento.
	⚠ CUIDADO Risco de queda de peças devido a parafusos desapertados! Lesões devido à queda de peças. ▶ Proteja o componente contra as quedas.
	ATENÇÃO! Risco de queda de peças devido a parafusos desapertados! Danos em outros componentes do aparelho ou na casa do cliente, p. ex., no pavimento. ▶ Proteja o componente contra as quedas.

Pré-requisito:

- ✔ O aparelho está desligado da energia.
- ✔ O aparelho está desligado do abastecimento de água.
- ✔ O aparelho está livremente acessível.
- ✔ [O tampo foi removido.→381](#)
- ✔ [A gaveta para detergente foi removida.→383](#)
- ✔ O painel da fachada foi removido.

4.9.1 Remover a luz do tambor

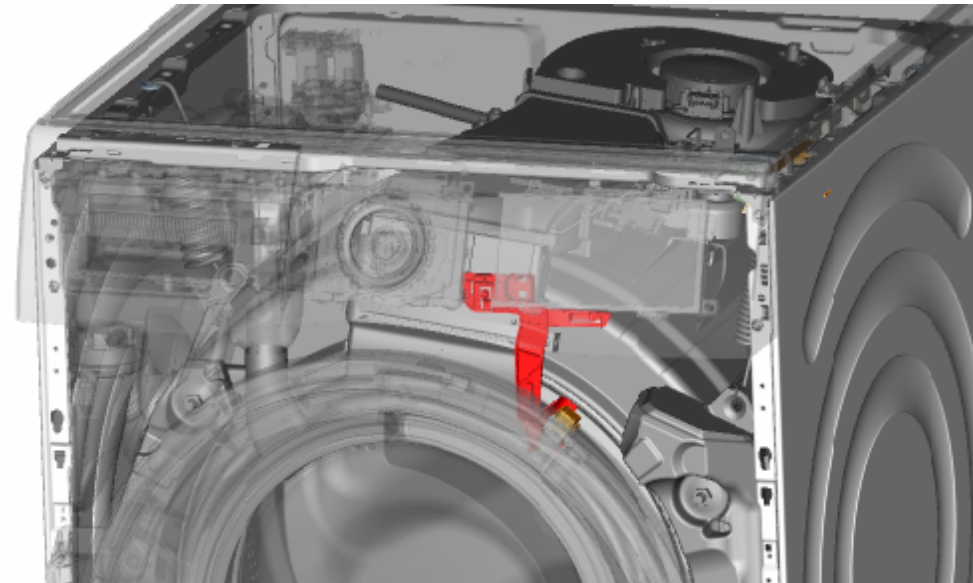

1. Puxe o suporte da luz do tambor para fora do aparelho.
2. Desligue as ligações elétricas.
3. Remova a luz do tambor do suporte da luz do tambor.

4.9.2 Instalar a luz do tambor

- ▶ Instale pela ordem inversa.

4.10 Substituir a tampa da bomba

Pré-requisito:

- ✓ O aparelho está desligado da energia.
- ✓ O aparelho está desligado do abastecimento de água.

4.10.1 Remover a tampa da bomba

1. Abra a tampa da bomba.

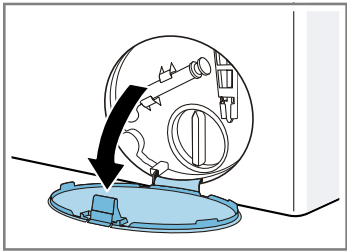

2. Remova a tampa da bomba.

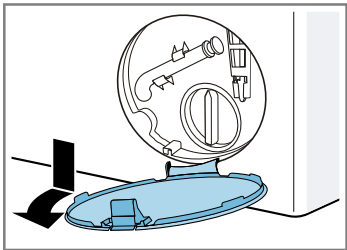

4.10.2 Instalar a tampa da bomba

- ▶ Instale pela ordem inversa.

4.11 Substituir o painel frontal



⚠️ CUIDADO

Arestas vivas no alojamento!
Lesões por corte
▶ Use luvas de proteção.

Pré-requisito:

- ✔ O aparelho está desligado da energia.
- ✔ O aparelho está desligado do abastecimento de água.
- ✔ [A gaveta para detergente foi removida.→383](#)
- ✔ [A porta foi removida.→385](#)
- ✔ A vedação da porta foi removida.
- ✔ [A tampa da bomba foi removida.→394](#)

4.11.1 Remover o painel frontal

1.



⚠️ AVISO

Deslizamento de aparelhos inclinados!
Fraturas ósseas / ferimentos de esmagamento
▶ Proteja os aparelhos contra o deslizamento.

Levante o aparelho na parte da frente.

2. Remova os parafusos na parte inferior (1).

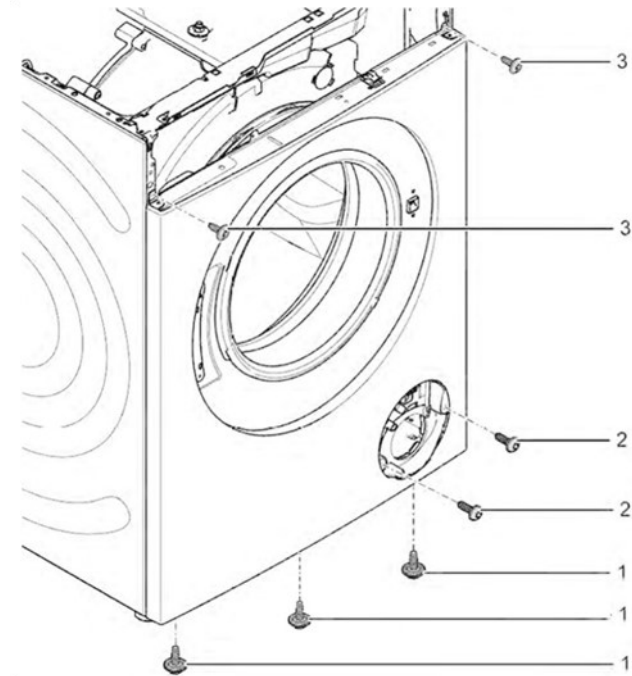

3. Baixe o aparelho.

Reparação

4. 1. Remova os parafusos (1).
2. Empurre o tampo para a parte de trás do aparelho (2).
3. Mova o tampo para cima (3) para removê-lo.

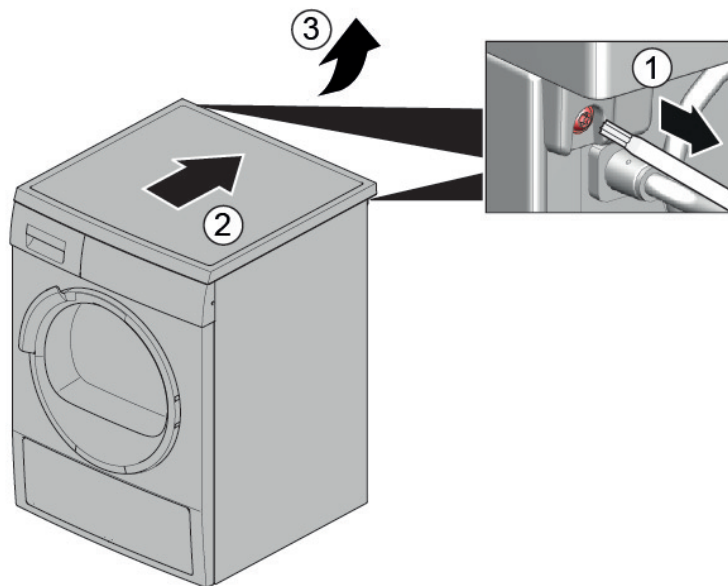

5. 1. Remova os parafusos (1).
2. Solte os elementos de encaixe (2, 3).

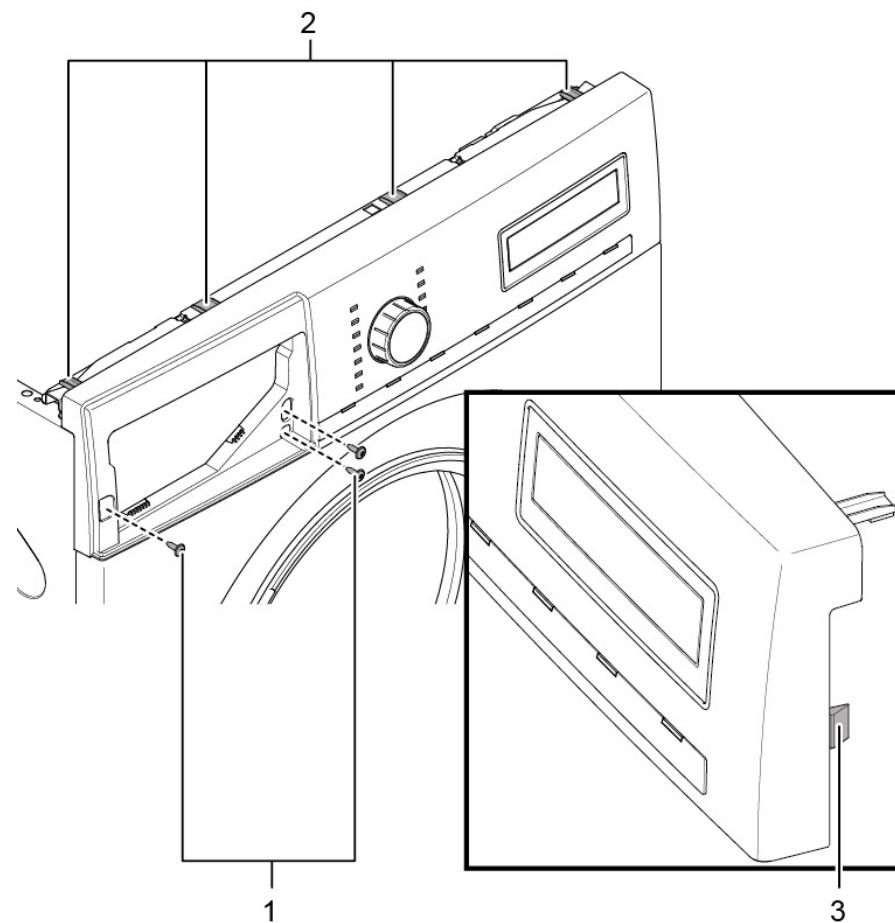

6. Remova o painel da fachada.

7.



⚠ CUIDADO

Risco de queda de peças devido a parafusos desapertados!

Lesões devido à queda de peças.

- ▶ Proteja o componente contra as quedas.



ATENÇÃO!

Risco de queda de peças devido a parafusos desapertados!
Danos em outros componentes do aparelho ou na casa do cliente, p. ex., no pavimento.
► Proteja o componente contra as quedas.

Remova os parafusos na parte da frente começando de baixo para cima (2, 3).

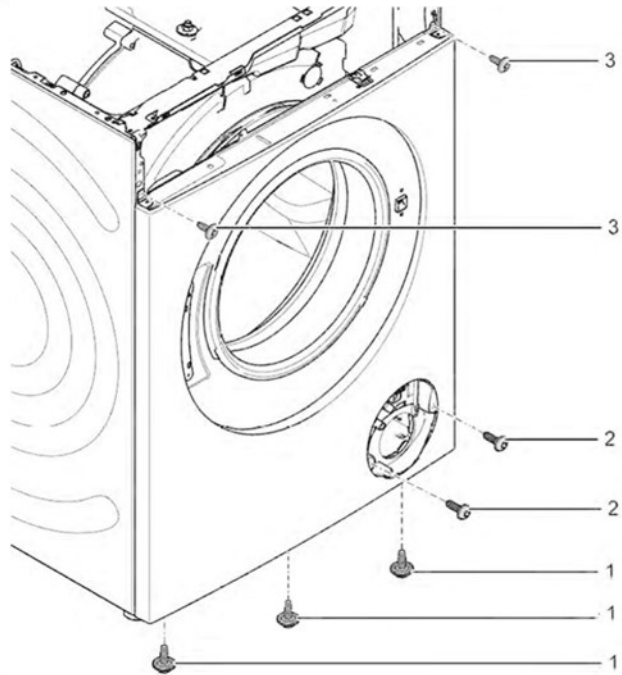

8. Remova o painel frontal.

4.11.2 Instalar o painel frontal

► Instale pela ordem inversa.

Indicii pentru reparații - Mașină de spălat rufe

Referitor la acest document..... 399

1.1	Informații importante	399
1.1.1	Aplicabilitatea	399
1.2	Explicația simbolurilor	399
1.2.1	Nivelurile de pericol	399
1.2.2	Simbolurile de pericol	399
1.2.3	Structura avertismentelor	400
1.2.4	Simbolurile generale	400

Siguranța..... 401

2.1	Instrucțiuni generale de siguranță	401
2.1.1	Toate aparatele electrocasnice	401

Instrumente și materiale utile..... 402

Repararea..... 403

4.1	Înlocuirea părții superioare	403
4.1.1	Demontarea părții superioare	403
4.1.2	Montarea părții superioare	403
4.2	Înlocuirea panoului de mascare	404
4.2.1	Demontarea panoului de mascare	404
4.2.2	Montarea panoului de mascare	404
4.3	Înlocuirea sertarului pentru detergent	405
4.3.1	Demontarea sertarului pentru detergent	405
4.3.2	Montarea sertarului pentru detergent	405
4.4	Înlocuirea mânerului sertarului pentru detergent	406
4.4.1	Demontarea mânerului sertarului pentru detergent	406
4.4.2	Montarea mânerului sertarului pentru detergent	406
4.5	Înlocuirea ușii	407
4.5.1	Demontarea ușii	407
4.5.2	Montarea ușii	407
4.6	Înlocuirea componentelor ușii	408
4.6.1	Demontarea componentelor ușii	408
4.6.2	Montarea componentelor ușii	408
4.7	Înlocuirea garniturii ușii	409
4.7.1	Demontarea garniturii ușii	409
4.7.2	Montarea garniturii ușii	412

4.8	Înlocuirea dispozitivului de blocare a ușii	413
4.8.1	Demontarea dispozitivului de blocare a ușii	413
4.8.2	Montarea dispozitivului de blocare a ușii	414
4.9	Înlocuirea iluminării cuvei.....	415
4.9.1	Demontarea iluminării cuvei	415
4.9.2	Montarea iluminării cuvei	415
4.10	Înlocuirea capacului pompei	416
4.10.1	Demontarea capacului pompei	416
4.10.2	Montarea capacului pompei	416
4.11	Înlocuirea panoului frontal.....	417
4.11.1	Demontarea panoului frontal	417
4.11.2	Montarea panoului frontal.....	419

i Referitor la acest document

1.1 Informații importante

1.1.1 Aplicabilitatea

Aceste instrucțiuni de reparare îl ajută pe client să își repare singur aparatele, în conformitate cu normele de proiectare ecologică aplicabile (începând cu 03/2021).





Acestea conțin informații privind modul de înlocuire a pieselor de schimb specifice, inclusiv avertismente și pericole.

Dacă aveți întrebări, vă rugăm să luați legătura cu serviciul relații clienți. Ne asumăm răspunderea pentru daune numai dacă instrucțiunile de reparare au fost respectate pe deplin.

1.2 Explicația simbolurilor

1.2.1 Nivelurile de pericol

Nivelurile de alertă sunt reprezentate printr-un simbol și un cuvânt de avertizare. Cuvântul de avertizare indică gravitatea pericolului.





Nivelul de alertă	Semnificație
 PERICOL	Nerespectarea mesajului de avertizare va provoca accidente grave sau decesul.
 AVERTISMENT	Nerespectarea mesajului de avertizare ar putea provoca accidente grave sau decesul.
 ATENȚIONARE	Nerespectarea mesajului de avertizare ar putea provoca accidente ușoare.
 ATENȚIE!	Nerespectarea mesajului de avertizare ar putea provoca daune asupra proprietății.

Tabel 1: Nivelurile de pericol



1.2.2 Simbolurile de pericol

Simbolurile de pericol sunt reprezentări simbolice care indică tipul de pericol.

În acest document sunt utilizate simbolurile de pericol de mai jos:

Simbol de pericol	Semnificație
	Mesaj de avertizare general
	Pericol din cauza tensiunii electrice
	Pericol de explozie
	Pericol de tăiere
	Pericol de zdrobire



Referitor la acest document

Simbol de pericol	Semnificație
	Pericol din cauza suprafețelor fierbinți
	Pericol din cauza câmpului magnetic puternic
	Pericol din cauza radiației neionizante

Tabel 2: Simbolurile de pericol

1.2.3 Structura avertismentelor

Avertismentele din acest document au un aspect și o structură standard.



	<div style="background-color: red; color: white; padding: 2px; text-align: center;"> PERICOL</div> <p>Tipul și sursa pericolului! Consecințele posibile ale ignorării pericolului/avertismentului.</p> <ul style="list-style-type: none"> ▶ Măsuri și interdicții pentru prevenirea pericolului.
--	--





Exemplul următor prezintă un avertisment privind electrocutarea din cauza pieselor sub tensiune. Se menționează măsura necesară pentru a evita pericolul.

	<div style="background-color: red; color: white; padding: 2px; text-align: center;"> PERICOL</div> <p>Pericol de electrocutare din cauza pieselor sub tensiune! Deces prin electrocutare</p> <ul style="list-style-type: none"> ▶ Deconectați aparatele de la sursa de alimentare cu tensiune cu cel puțin 60 de secunde înainte de a începe reparațiile.
---	---

1.2.4 Simbolurile generale

În acest document sunt utilizate simbolurile generale de mai jos:

Simbol general	Semnificație
	Identificarea unei recomandări speciale (text și/sau grafică)
	Identificarea unei recomandări simple (numai text)

Simbol general	Semnificație
	Identificarea unui link spre un videoclip instructiv
	Identificarea sculelor necesare
	Identificarea condițiilor preliminare necesare
	Identificarea unei stări (dacă..., apoi...)
	Identificarea unui rezultat
[Pornire]	Identificarea unei taste sau a unui buton
[00123456]	Identificarea unui număr de serie
Stare	Identificarea unui text/unei ferestre afișate (pe ecranul aparatului)

Tabel 3: Simbolurile generale

2.1 Instrucțiuni generale de siguranță

2.1.1 Toate aparatele electrocasnice

Pericol de electrocutare din cauza pieselor sub tensiune!

- Erorile care au loc în timpul reparațiilor efectuate la componentele electrice pot să ducă la electrocutări!
- Deconectați aparatul de la sursa de alimentare cu tensiune cu cel puțin 60 de secunde înainte de a începe lucrările.
- După reparație, este obligatorie efectuarea unei verificări de siguranță conform cu VDE 0701 sau cu reglementările naționale respective.

Pericol de rănire din cauza muchiilor ascuțite!

- Purtați mănuși de protecție.

Pericol de zdrobire în timpul lucrărilor de reparație, întreținere, depanare și service, din cauza componentelor grele și mobile

- Purtați încălțăminte de protecție.
- Fixați componentele grele împotriva căderii.
- Nu vă sprijiniți cu părți ale corpului de componentele mobile.







Pericol pentru siguranța/funcționarea aparatului!





- Utilizați numai piese de schimb originale.

Pericol de deteriorare a componentelor sensibile la electricitatea statică (ESD)!

- Nu atingeți modulele, inclusiv conexiunile și căile conductorilor.

Instrumente și materiale utile

Desemnare	Detalii	Imagini
Instrumentul auxiliar [15000155]	Instrument pentru slăbirea pieselor din plastic	
Șurubelniță Torx T20 cu orificiu [00340764]	100 mm, pentru șuruburi cu știft de siguranță	
Cheie de cuplu [15000441]	Cheie de cuplu 20 - 100 Nm	
Șurubelniță cu slot [00340854]	Lamă 3,5 mm x 0,6 mm x 100 mm, Izolație protectoare 1000 V CA	
Șurubelniță cu slot [00340855]	Lamă 5,5 mm x 1,0 mm x 125 mm, Izolație protectoare 1000 V CA	
Clește cu cios, model unghiular [00341269]	Lungime 200 mm	
Clește cu tăiere laterală [00342182]	Lungime: 200 mm	



Desemnare	Detalii	Imagini
Cheie fixă inelară [00340811]	Dimensiune cheie 10°mm, M6	
Combination wrench [00340814]	Dimensiune cheie 13°mm, M8	
Cheie fixă inelară [00340817]	Dimensiune cheie 17 mm, M10	
Cheie fixă inelară [15000459]	Dimensiune cheie 16°mm, M10	

4.1 Înlocuirea părții superioare

Scule speciale:

-  Cap Torx TX20 cu orificiu, lung 6,3 mm (1/4") 152 mm, pentru șuruburi cu știft de siguranță [00341272]

Cerință:

-  Aparatul este deconectat de la sursa de energie electrică.
-  Aparatul este deconectat de la sursa de alimentare cu apă.

4.1.1 Demontarea părții superioare

- ▶ 1. Scoateți șuruburile (1).
- ▶ 2. Împingeți partea superioară către partea din spate a aparatului (2).
- ▶ 3. Mutați în sus partea superioară (3) pentru demontare.

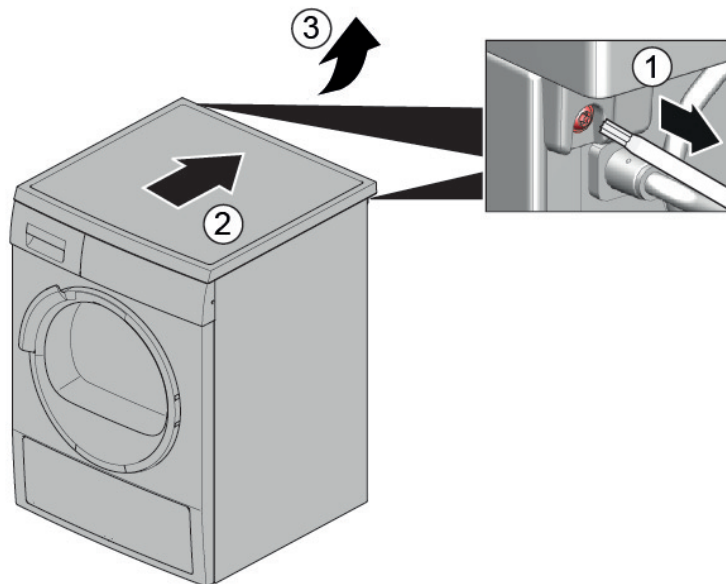

4.1.2 Montarea părții superioare

- ▶ Montați urmând procedura de demontare în ordine inversă.

4.2 Înlocuirea panoului de mascare



⚠️ ATENȚIONARE

Muchii ascuțiți ale carcasei!

Tăieturi

- ▶ Purtați mănuși de protecție.



⚠️ AVERTISMENT

Alunecarea aparatelor înclinate!

Fracturi/zdrobiri

- ▶ Fixați aparatele împotriva alunecării.



⚠️ ATENȚIONARE

Pericol din cauza pieselor care cad pentru că șuruburile sunt slăbite!

Accidente din cauza pieselor care cad.

- ▶ Fixați componenta împotriva căderii.



⚠️ ATENȚIE!

Pericol din cauza pieselor care cad pentru că șuruburile sunt slăbite!

Deteriorarea altor piese ale aparatului sau a casei clientului, de exemplu, partea de jos.

- ▶ Fixați componenta împotriva căderii.

Cerință:

- ✔️ Aparatul este deconectat de la sursa de energie electrică.
- ✔️ Aparatul este deconectat de la sursa de alimentare cu apă.
- ✔️ [Partea superioară a fost demontată. →403](#)
- ✔️ [Sertarul pentru detergent a fost demontat. →405](#)

4.2.1 Demontarea panoului de mascare

1. Scoateți șuruburile (1).
2. Decuplați elementele de prindere (2, 3).

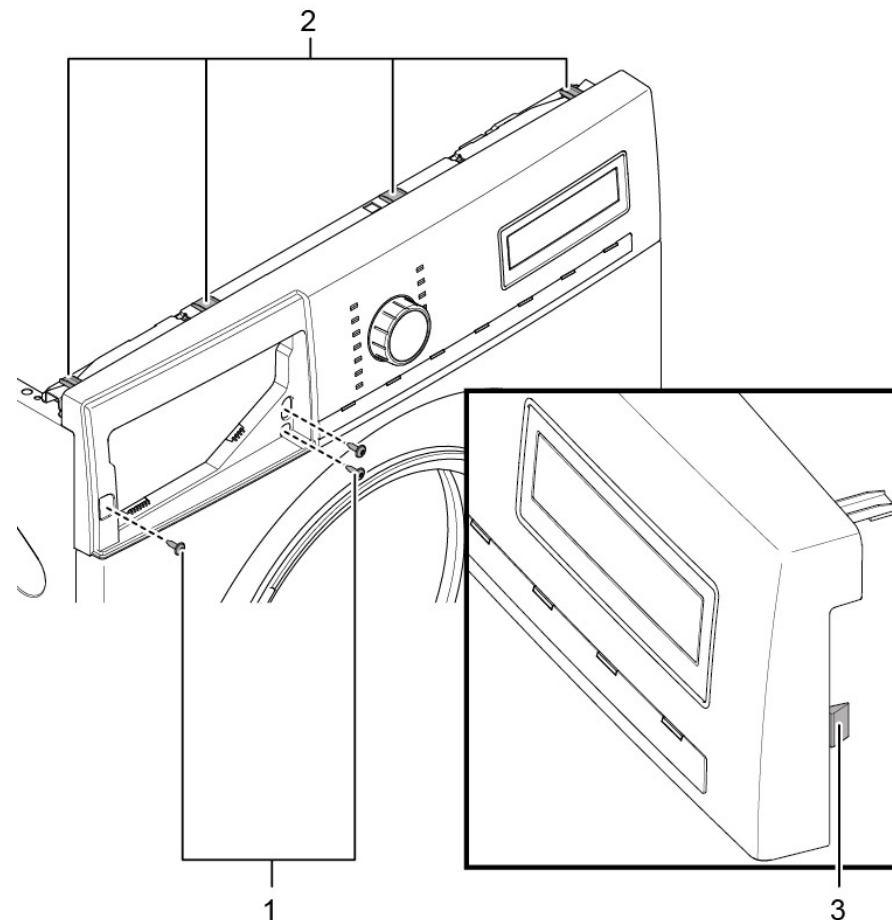

2. Decuplați contactul cu fișe al unității de comandă.
3. Demontați panoul de mascare.

4.2.2 Montarea panoului de mascare

- ▶ Montați urmând procedura de demontare în ordine inversă.

4.3 Înlocuirea sertarului pentru detergent

Cerință:

- ✓ Aparatul este deconectat de la sursa de energie electrică.
- ✓ Aparatul este deconectat de la sursa de alimentare cu apă.

4.3.1 Demontarea sertarului pentru detergent

1. Deschideți complet sertarul pentru detergent.
2. 1. Apăsați în jos pe inserție (1).
2. Scoateți sertarul pentru detergent (2).

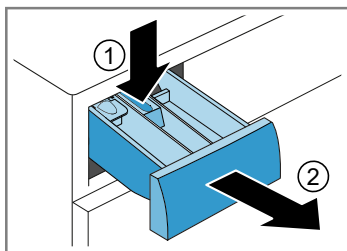

4.3.2 Montarea sertarului pentru detergent

- ▶ Montați urmând procedura de demontare în ordine inversă.

4.4 Înlocuirea mânerului sertarului pentru detergent

Cerință:

- ✓ Aparatul este deconectat de la sursa de energie electrică.
- ✓ Aparatul este deconectat de la sursa de alimentare cu apă.
- ✓ [Sertarul pentru detergent a fost demontat.](#)→405

4.4.1 Demontarea mânerului sertarului pentru detergent

1. Decuplați elementele de prindere.

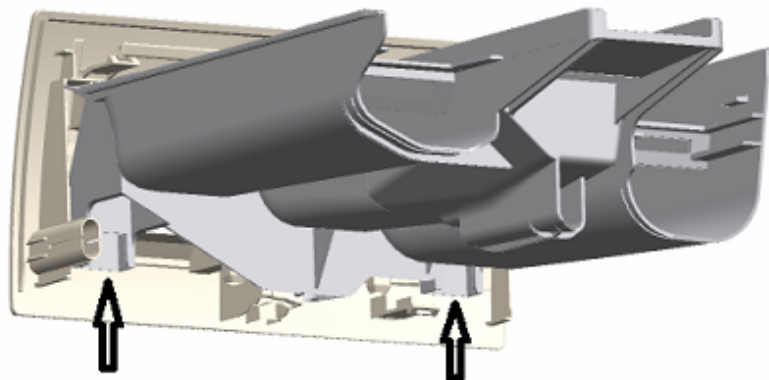

2. Scoateți mânerul sertarului pentru detergent.

4.4.2 Montarea mânerului sertarului pentru detergent

- ▶ Montați urmând procedura de demontare în ordine inversă.

4.5 Înlocuirea ușii



⚠️ ATENȚIONARE

Zona balamalei deschise!

Zdrobirea/prinderea degetelor

- ▶ Nu introduceți degetele sau mâna în zona balamalei.
- ▶ Purtați mănuși de protecție.

Cerință:

- ✔ Aparatul este deconectat de la sursa de energie electrică.
- ✔ Aparatul este deconectat de la sursa de alimentare cu apă.
- ✔ Ușa este deschisă.

4.5.1 Demontarea ușii

1.



⚠️ ATENȚIE!

Pericol din cauza pieselor care cad pentru că șuruburile sunt slăbite!

Deteriorarea altor piese ale aparatului sau a casei clientului, de exemplu, partea de jos.

- ▶ Fixați componenta împotriva căderii.



⚠️ ATENȚIONARE

Pericol din cauza pieselor care cad pentru că șuruburile sunt slăbite!

Accidente din cauza pieselor care cad.

- ▶ Fixați componenta împotriva căderii.

Scoateți șuruburile (1).

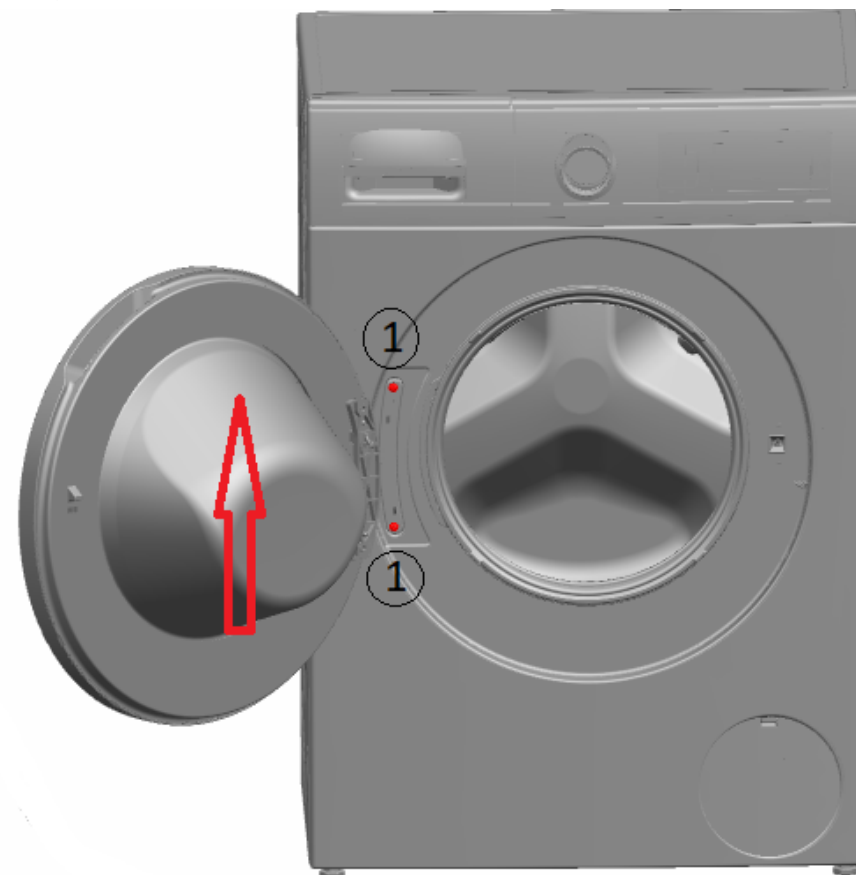

2. Scoateți ușa ridicând-o în sus.

4.5.2 Montarea ușii

- ▶ Montați urmând procedura de demontare în ordine inversă.

4.6 Înlocuirea componentelor ușii



ATENȚIONARE

Zona balamalei deschise!

Zdrobirea/prinderea degetelor

- ▶ Nu introduceți degetele sau mâna în zona balamalei.
- ▶ Purtați mănuși de protecție.

Cerință:

- ✔ Aparatul este deconectat de la sursa de energie electrică.
- ✔ Aparatul este deconectat de la sursa de alimentare cu apă.
- ✔ [Ușa a fost demontată. → 407](#)

4.6.1 Demontarea componentelor ușii

- ▶ Dezasamblați ușa dinspre exterior înspre interior.

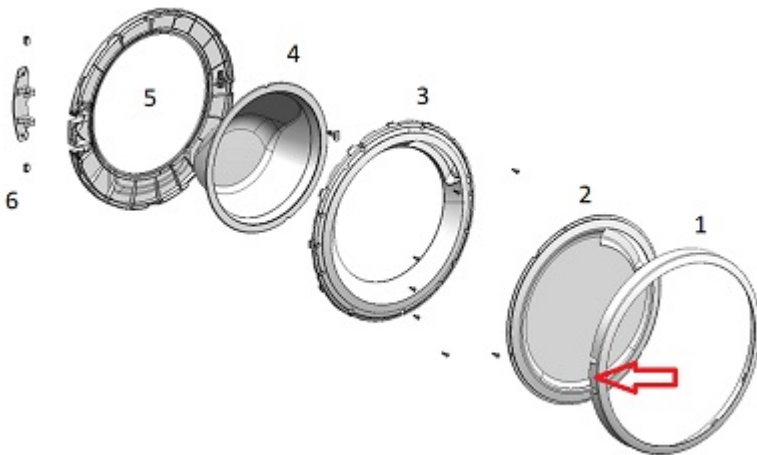

4.6.2 Montarea componentelor ușii

- ▶ Montați urmând procedura de demontare în ordine inversă.

4.7 Înlocuirea garniturii ușii



⚠️ ATENȚIONARE

Muchii ascuțiți ale carcasei!

Tăieturi

- ▶ Purtați mănuși de protecție.



⚠️ ATENȚIONARE

Pericol din cauza pieselor care cad pentru că șuruburile sunt slăbite!

Accidente din cauza pieselor care cad.

- ▶ Fixați componenta împotriva căderii.



⚠️ ATENȚIE!

Pericol din cauza pieselor care cad pentru că șuruburile sunt slăbite!

Deteriorarea altor piese ale aparatului sau a casei clientului, de exemplu, partea de jos.

- ▶ Fixați componenta împotriva căderii.

Cerință:

- ✔️ Aparatul este deconectat de la sursa de energie electrică.
- ✔️ Aparatul este deconectat de la sursa de alimentare cu apă.
- ✔️ [Sertarul pentru detergent a fost demontat. →405](#)
- ✔️ [Ușa a fost demontată. →407](#)
- ✔️ [Capacul pompei a fost demontat. →416](#)

4.7.1 Demontarea garniturii ușii

1.



⚠️ AVERTISMENT

Alunecarea aparatelor înclinate!

Fracturi/zdrobiri

- ▶ Fixați aparatele împotriva alunecării.

Ridicați aparatul de partea din față.

2. Desfaceți șuruburile din partea inferioară a panoului frontal (1).

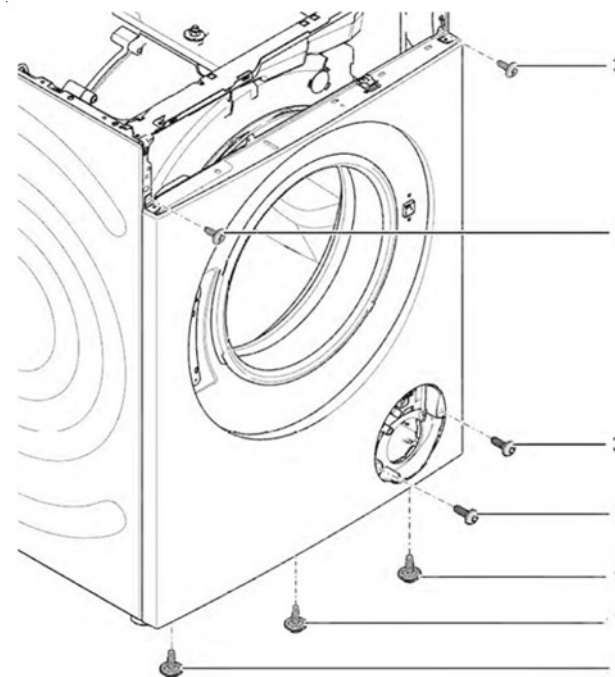

3. Coborâți aparatul.

Repararea

4. Scoateți șuruburile din zona pompei (2).

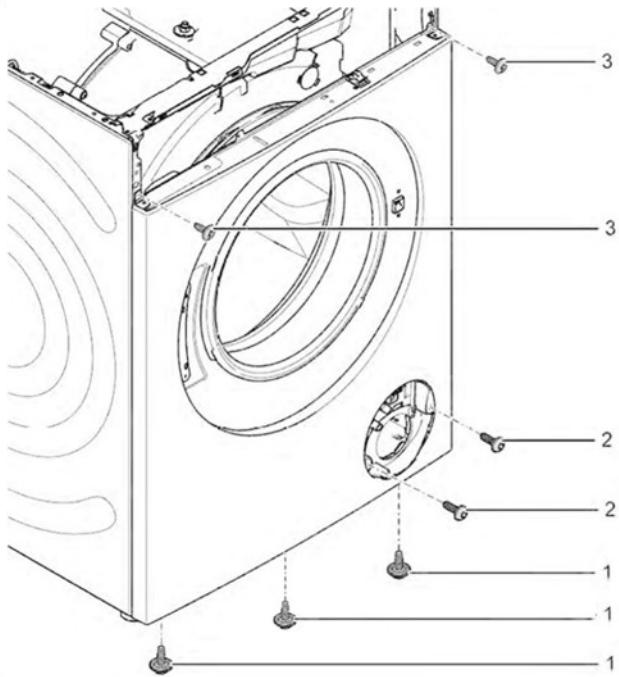

5. 1. Desfaceți șuruburile din partea din spate a aparatului (1).
2. Demontați partea superioară (2, 3).

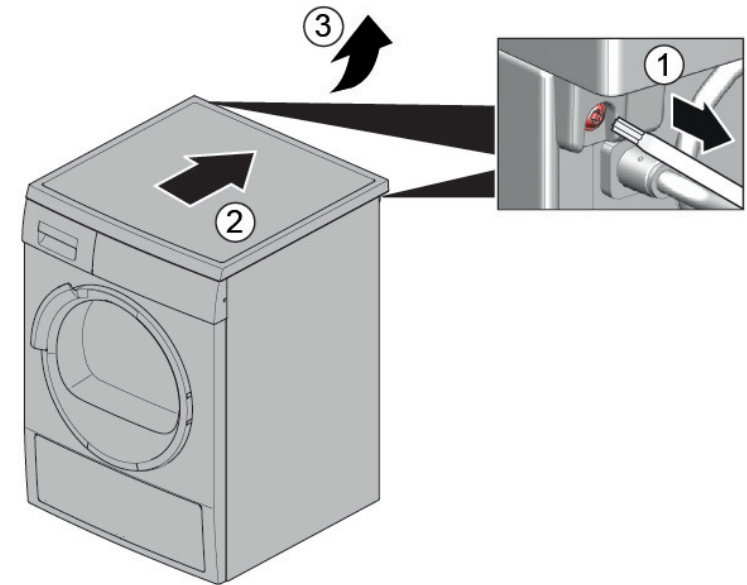

Repararea

6. 1. Scoateți șuruburile (1).
2. Decuplați elementele de prindere ale panoului de mascare (2, 3).
3. Desfaceți șuruburile carcasei dozatorului.

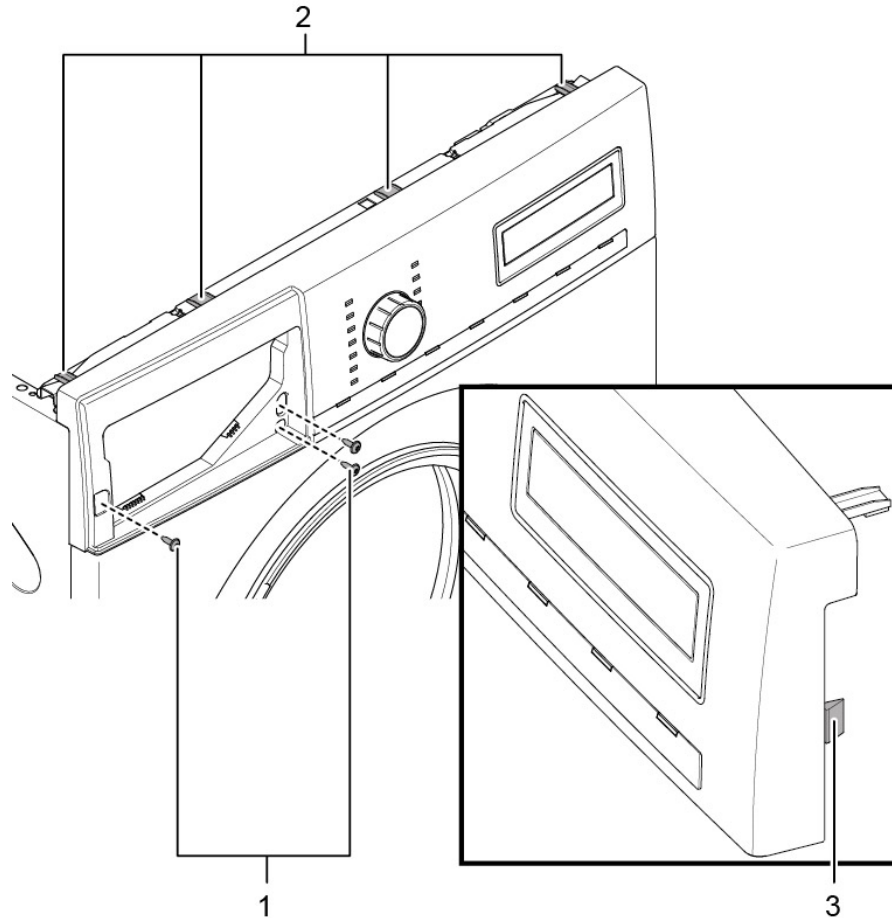

7. Demontați panoul de mascare.

8. Demontați suportul iluminării cuvei din partea de sus.

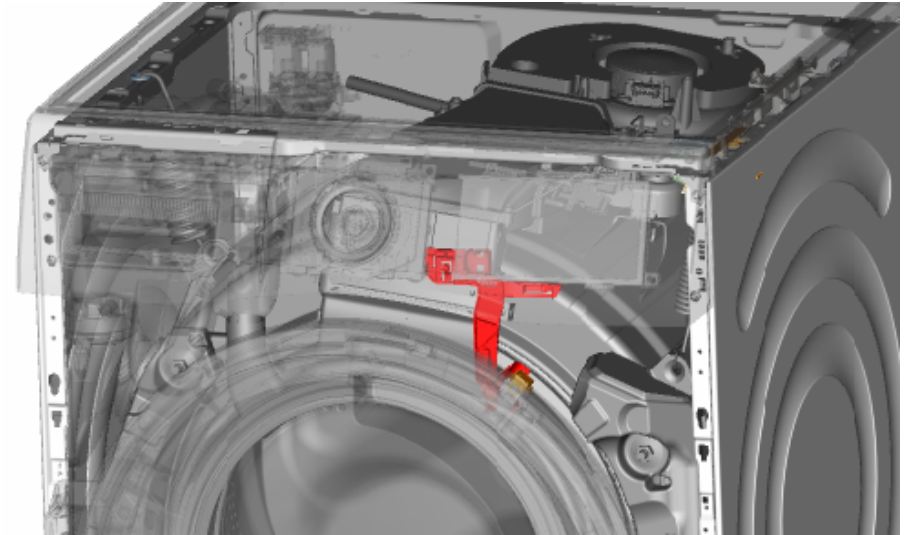

- 9.



ATENȚIE!

Pericol de suprafață deteriorată!

Suprafața aparatului se poate zgâria dacă folosiți instrumentele greșite.

- ▶ Folosiți numai instrumente din plastic pentru a înlocui inelul de tensionare.

Scoateți inelul de tensionare din garnitură cu un instrument din plastic.

10. Decuplați garnitura ușii de la panoul frontal.
11. Decuplați conectorul cablului de la dispozitivul de blocare a ușii.

12. Desfaceți șuruburile din partea superioară a panoului frontal (3).

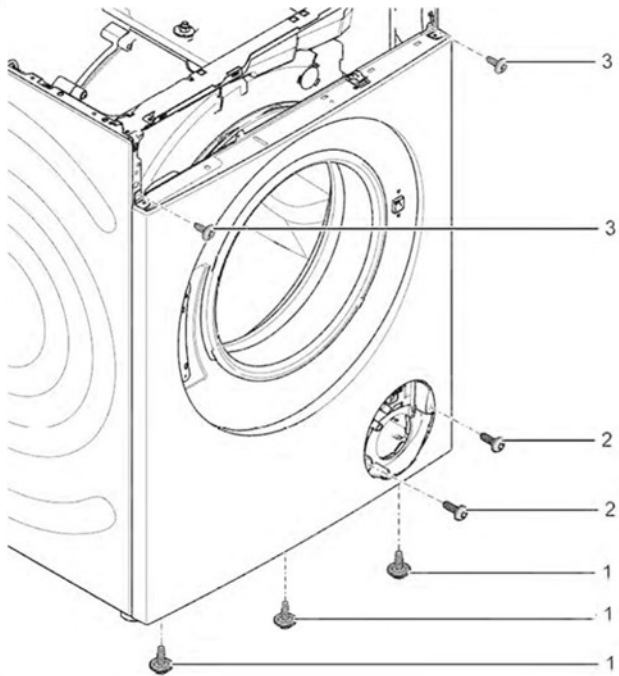

13. Demontați panoul frontal.

14. Deconectați toate racordurile furtunurilor.

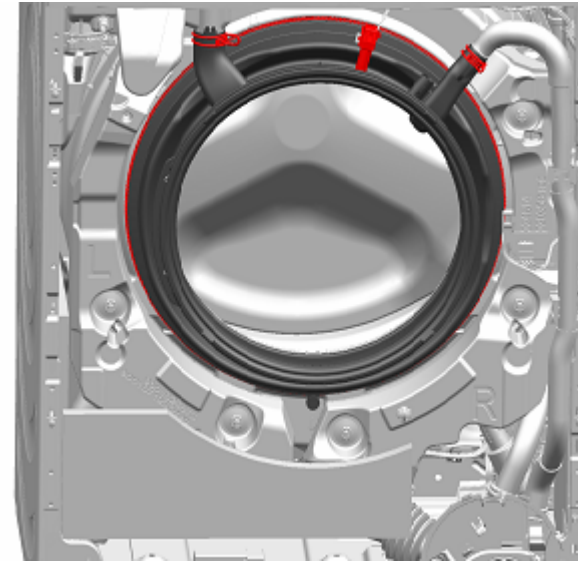

15. Scoateți garnitura ușii.

4.7.2 Montarea garniturii ușii

	AVERTISMENT
	Pericol din cauza pieselor în cădere din cauza instalării incorecte! Rănire sau deteriorarea aparatului. ▶ Strângeți inelul de tensionare din garnitura de cauciuc cu 3,4 Nm.

▶ Montați urmând procedura de demontare în ordine inversă.

4.8 Înlocuirea dispozitivului de blocare a uşii

În calitate de producător, suntem obligați să le oferim clienților piesa de schimb sistem de blocare pentru uşă, inclusiv instrucțiuni de reparare, în conformitate cu regulamentul (UE) 2019/2023. Am dori să subliniem însă, că, după înlocuirea sistemului de blocare a uşii, este obligatorie efectuarea unei verificări de siguranță electrotehnică de către un electrician calificat înainte ca dispozitivul să poată fi pus în funcțiune. Această persoană trebuie să fie calificată în mod certificabil în conformitate cu legile, reglementările și standardele naționale respective.

	⚠ PERICOL
	<p>Pericol de electrocutare din cauza pieselor sub tensiune! Pericol de moarte prin electrocutare în cazul unei reparații necorespunzătoare</p> <ul style="list-style-type: none"> ▶ Componentele electrice trebuie reparate de către electricieni calificați. ▶ După reparație, este obligatorie efectuarea unei verificări de siguranță conform cu VDE 0701 sau cu reglementările naționale respective.

	⚠ ATENȚIONARE
	<p>Muchii ascuțiți ale carcasei! Tăieturi</p> <ul style="list-style-type: none"> ▶ Purtați mănuși de protecție.

	⚠ AVERTISMENT
	<p>Alunecarea aparatelor înclinate! Fracturi/zdrobiri</p> <ul style="list-style-type: none"> ▶ Fixați aparatele împotriva alunecării.

	⚠ ATENȚIONARE
	<p>Pericol din cauza pieselor care cad pentru că șuruburile sunt slăbite! Accidente din cauza pieselor care cad.</p> <ul style="list-style-type: none"> ▶ Fixați componenta împotriva căderii.

	ATENȚIE!
	<p>Pericol din cauza pieselor care cad pentru că șuruburile sunt slăbite! Deteriorarea altor piese ale aparatului sau a casei clientului, de exemplu, partea de jos.</p> <ul style="list-style-type: none"> ▶ Fixați componenta împotriva căderii.

Cerință:

- ✓ Aparatul este deconectat de la sursa de energie electrică.
- ✓ Aparatul este deconectat de la sursa de alimentare cu apă.
- ✓ Aparatele sunt accesibile.
- ✓ [Partea superioară a fost demontată. →403](#)
- ✓ Panoul de mascare a fost demontat.
- ✓ [Ușa a fost demontată. →407](#)
- ✓ Inelul de tensionare a fost demontat.
- ✓ Panoul frontal a fost demontat.
- ✓ Garnitura uşii a fost demontată.

4.8.1 Demontarea dispozitivului de blocare a uşii

1. Deconectați fișa dispozitivului de blocare a uşii.
2. Decuplați dispozitivul de blocare a uşii.



3. Demontați dispozitivul de blocare a uşii.

4.8.2 Montarea dispozitivului de blocare a ușii

Pentru ca deschiderea de urgență a ușii aparatului să funcționeze corespunzător, dispozitivul de blocare a ușii trebuie să fie în poziția corectă.

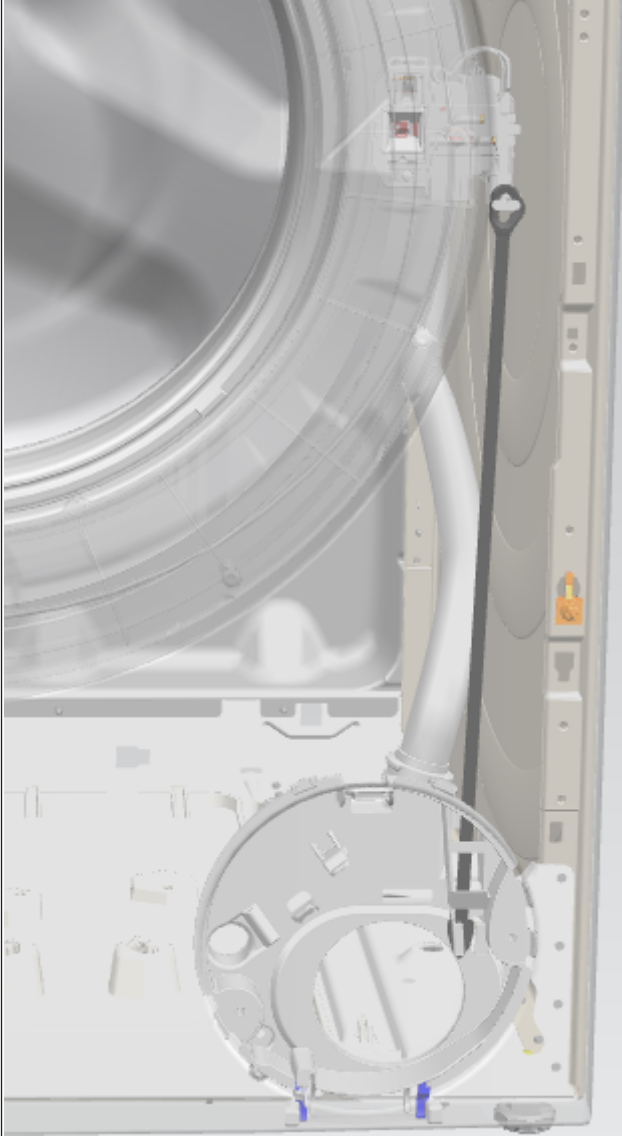



- ▶ Montați urmând procedura de demontare în ordine inversă.

4.9 Înlocuirea iluminării cuvei

	⚠ ATENȚIONARE Muchii ascuțiți ale carcasei! Tăieturi ▶ Purtați mănuși de protecție.
--	--

	⚠ AVERTISMENT Alunecarea aparatelor înclinate! Fracturi/zdrobiri ▶ Fixați aparatele împotriva alunecării.
--	--

	⚠ ATENȚIONARE Pericol din cauza pieselor care cad pentru că șuruburile sunt slăbite! Accidente din cauza pieselor care cad. ▶ Fixați componenta împotriva căderii.
--	---

	ATENȚIE! Pericol din cauza pieselor care cad pentru că șuruburile sunt slăbite! Deteriorarea altor piese ale aparatului sau a casei clientului, de exemplu, partea de jos. ▶ Fixați componenta împotriva căderii.
--	--

Cerință:

- ✔ Aparatul este deconectat de la sursa de energie electrică.
- ✔ Aparatul este deconectat de la sursa de alimentare cu apă.
- ✔ Aparatele sunt accesibile.
- ✔ [Partea superioară a fost demontată.→403](#)
- ✔ [Sertarul pentru detergent a fost demontat.→405](#)
- ✔ Panoul de mascare a fost demontat.

4.9.1 Demontarea iluminării cuvei

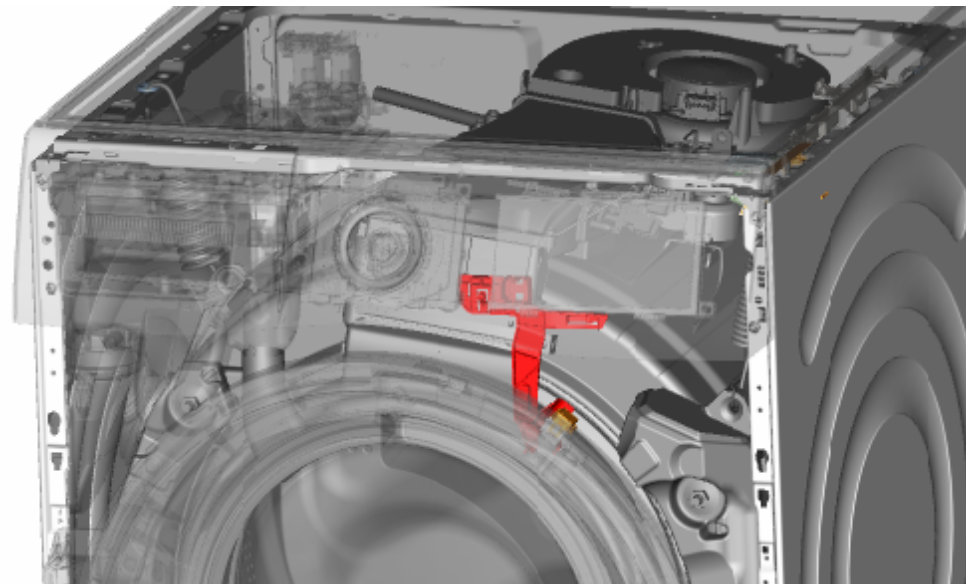

1. Trageți suportul iluminării cuvei afară din aparat.
2. Deconectați conexiunile electrice.
3. Demontați iluminarea cuvei din suport.

4.9.2 Montarea iluminării cuvei

- ▶ Montați urmând procedura de demontare în ordine inversă.

4.10 Înlocuirea capacului pompei

Cerință:

- ✓ Aparatul este deconectat de la sursa de energie electrică.
- ✓ Aparatul este deconectat de la sursa de alimentare cu apă.

4.10.1 Demontarea capacului pompei

1. Deschideți capacul pompei.

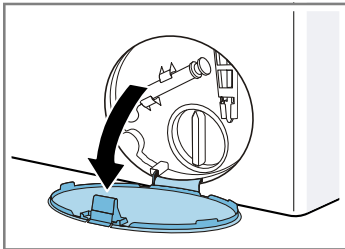

2. Scoateți capacul pompei.

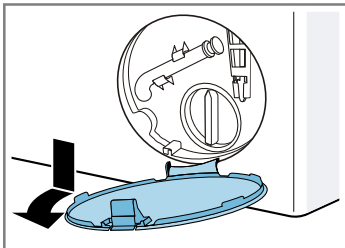

4.10.2 Montarea capacului pompei

- ▶ Montați urmând procedura de demontare în ordine inversă.

4.11 Înlocuirea panoului frontal



⚠️ ATENȚIONARE

Muchii ascuți ale carcasei!

Tăieturi

- ▶ Purtați mănuși de protecție.

Cerință:

- ✓ Aparatul este deconectat de la sursa de energie electrică.
- ✓ Aparatul este deconectat de la sursa de alimentare cu apă.
- ✓ [Sertarul pentru detergent a fost demontat. → 405](#)
- ✓ [Ușa a fost demontată. → 407](#)
- ✓ Garnitura ușii a fost demontată.
- ✓ [Capacul pompei a fost demontat. → 416](#)

4.11.1 Demontarea panoului frontal

1.



⚠️ AVERTISMENT

Alunecarea aparatelor înclinate!

Fracturi/zdrobiri

- ▶ Fixați aparatele împotriva alunecării.

Ridicați aparatul de partea din față.

2. Scoateți șuruburile din partea inferioară (1).

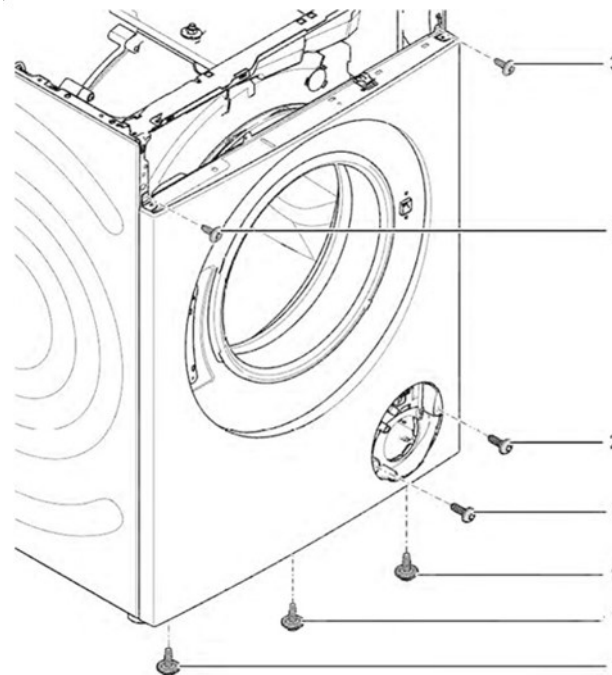

3. Coborâți aparatul.

Repararea

4. 1. Scoateți șuruburile (1).
2. Împingeți partea superioară către partea din spate a aparatului (2).
3. Mutați în sus partea superioară (3) pentru demontare.

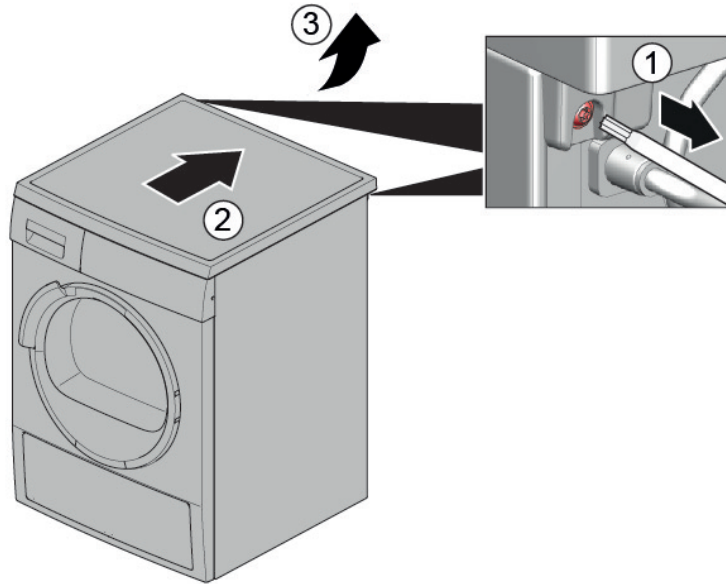

5. 1. Scoateți șuruburile (1).
2. Decuplați elementele de prindere (2, 3).

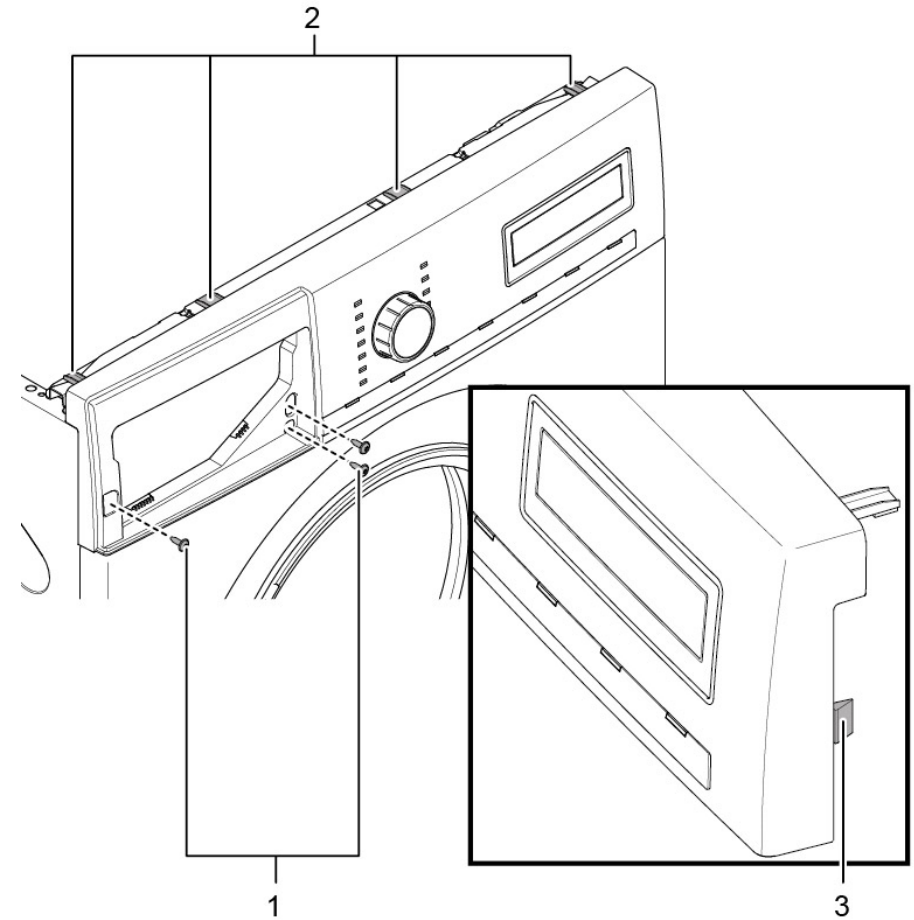

6. Demontați panoul de mascare.

7.



ATENȚIONARE

Pericol din cauza pieselor care cad pentru că șuruburile sunt slăbite!

Accidente din cauza pieselor care cad.

- Fixați componenta împotriva căderii.



ATENȚIE!

Pericol din cauza pieselor care cad pentru că șuruburile sunt slăbite!

Deteriorarea altor piese ale aparatului sau a casei clientului, de exemplu, partea de jos.

- ▶ Fixați componenta împotriva căderii.

Scoateți șuruburile din față, de jos în sus (2, 3).

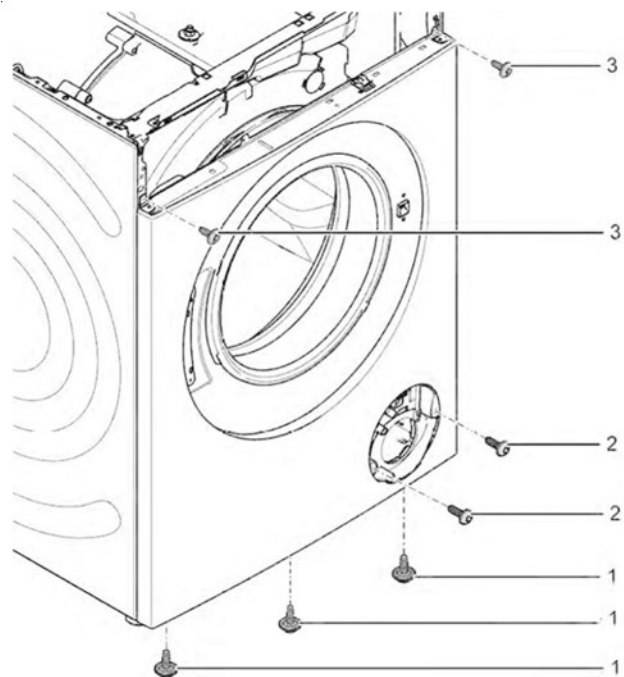

8. Demontați panoul frontal.

4.11.2 Montarea panoului frontal

- ▶ Montați urmând procedura de demontare în ordine inversă.

Poznámky k opravám - Práčka

 O tomto dokumente	421
1.1 Dôležité informácie	421
1.1.1 Účel	421
1.2 Vysvetlenie symbolov	421
1.2.1 Úrovne nebezpečenstva	421
1.2.2 Symboly označujúce riziká.....	421
1.2.3 Štruktúra varovaní.....	422
1.2.4 Všeobecné symboly	422
 Bezpečnosť	423
2.1 Všeobecné bezpečnostné pokyny	423
2.1.1 Všetky domáce spotrebiče.....	423
 Nástroje a pomôcky	424
 Oprava	425
4.1 Výmena pracovnej plochy	425
4.1.1 Odoberanie pracovnej plochy	425
4.1.2 Montáž pracovnej plochy	425
4.2 Výmena panelu obloženia	426
4.2.1 Odstránenie panelu obloženia.....	426
4.2.2 Montáž panelu obloženia.....	426
4.3 Výmena zásuvky na prací prostriedok.....	427
4.3.1 Odstránenie zásuvky na prací prostriedok	427
4.3.2 Montáž zásuvky na prací prostriedok	427
4.4 Výmena držadla zásuvky na prací prostriedok.....	428
4.4.1 Odstránenie držadla zásuvky na prací prostriedok	428
4.4.2 Montáž držadla zásuvky na prací prostriedok.....	428
4.5 Výmena dverí	429
4.5.1 Odoberanie dverí	429
4.5.2 Montáž dverí.....	429
4.6 Výmena komponentov dverí.....	430
4.6.1 Odoberanie komponentov dverí	430
4.6.2 Montáž komponentov dverí.....	430
4.7 Výmena tesnenia dverí	431
4.7.1 Odoberanie tesnenia dverí.....	431
4.7.2 Montáž tesnenia dverí	434

4.8 Výmena poistky dvierok.....	435
4.8.1 Odoberanie poistky dvierok	435
4.8.2 Montáž poistky dvierok	436
4.9 Výmena osvetlenia bubna	437
4.9.1 Odoberanie osvetlenia bubna.....	437
4.9.2 Montáž osvetlenia bubna	437
4.10 Výmena krytu čerpadla.....	438
4.10.1 Odoberanie krytu čerpadla	438
4.10.2 Montáž krytu čerpadla.....	438
4.11 Výmena čelného panela	439
4.11.1 Odstránenie čelného panela.....	439
4.11.2 Montáž čelného panela	441

i O tomto dokumente

1.1 Dôležité informácie

1.1.1 Účel

Tieto pokyny pre opravu pomáhajú spotrebiteľovi pri vlastnej oprave spotrebičov podľa nariadenia o ekodizajne (z marca 2021).

Obsahujú informácie o výmene určených náhradných dielov vrátane varovaní a rizík.

Ak máte otázky, kontaktujte náš zákaznícky servis. Za poškodenia ručíme len vtedy, ak pokyny boli dodržané správne.

1.2 Vysvetlenie symbolov

1.2.1 Úrovne nebezpečenstva

Úroveň varovania obsahuje symbol a signalizačné slovo. Signalizačné slovo naznačuje mieru nebezpečenstva.





Úroveň varovania	Význam
 NEBEZPEČENSTVO	Následkom nerešpektovania varovného hlásenia je úmrtie alebo vážne zranenia.
 VAROVANIE	Možným následkom nerešpektovania varovného hlásenia je úmrtie alebo vážne zranenia.
 UPOZORNENIE	Možným následkom nerešpektovania varovného hlásenia sú mierne zranenia.
 POZOR!	Možným následkom nerešpektovania varovného hlásenia je poškodenie majetku.

Tabuľka 1: Úrovne nebezpečenstva



1.2.2 Symboly označujúce riziká

Symboly označujúce riziká sú symbolické znázornenia, ktoré naznačujú druh nebezpečenstva.

V tomto dokumente sa používajú nasledujúce symboly označujúce riziká:

Symbol označujúci riziko	Význam
	Všeobecné varovné hlásenie
	Nebezpečenstvo v súvislosti s elektrickým napätím
	Nebezpečenstvo výbuchu
	Nebezpečenstvo porezania
	Nebezpečenstvo pomliaždenia

i O tomto dokumente

Symbol označujúci riziko	Význam
	Nebezpečenstvo v súvislosti s horúcimi povrchmi
	Nebezpečenstvo v súvislosti s magnetickým poľom
	Nebezpečenstvo v súvislosti s neionizujúcou radiáciou

Tabuľka 2: Symboly označujúce riziká

1.2.3 Štruktúra varovaní

Varovania v tomto dokumente majú štandardný vzhľad a štandardnú štruktúru.



	<p>⚠ NEBEZPEČENSTVO</p> <p>Druh a zdroj nebezpečenstva! Možné následky pri ignorovaní nebezpečenstva/varovania.</p> <ul style="list-style-type: none"> ▶ Opatrenia a zákazy na zabránenie nebezpečenstvu.
--	--





Nasledujúci príklad znázorňuje varovanie pred zásahom elektrickým prúdom pri dotyku s časťami pod napätím. Je uvedené opatrenie na predídenie nebezpečenstvu.

	<p>⚠ NEBEZPEČENSTVO</p> <p>Nebezpečenstvo úrazu elektrickým prúdom pri dotyku s časťami pod napätím! Úmrtie v dôsledku zásahu elektrickým prúdom</p> <ul style="list-style-type: none"> ▶ Odpojte spotrebiče od elektrického zdroja aspoň 60 sekúnd pred začiatkom opráv.
---	--

1.2.4 Všeobecné symboly

V tomto dokumente sa používajú nasledujúce všeobecné symboly:

Všeob. symbol	Význam
	Označenie špeciálneho pokynu (textové a/alebo grafické)
	Označenie jednoduchého pokynu (len textové)

Všeob. symbol	Význam
	Označenie prepojenia na videonávod
	Označenie požadovaných nástrojov
	Označenie požadovaných podmienok
	Označenie podmienky (ak ..., potom ...)
	Označenie výsledku
[Spustenie]	Označenie klávesu alebo tlačidla
[00123456]	Označenie čísla materiálu
Stav	Označenie zobrazeného textu/okna (na displeji spotrebiča)

Tabuľka 3: Všeobecné symboly

2.1 Všeobecné bezpečnostné pokyny

2.1.1 Všetky domáce spotrebiče

Nebezpečenstvo úrazu elektrickým prúdom pri dotyku s časťami pod napätím!

- Chyby pri opravách na elektrických komponentoch môžu spôsobiť zásah elektrickým prúdom!
- Odpojte spotrebič od elektrickej siete aspoň 60 sekúnd pred začiatkom práce.
- Po oprave zariadenia vykonajte bezpečnostný test v súlade s nariadením VDE 0701 alebo s miestnymi nariadeniami.

Riziko poranenia na ostrých hranách!

- Noste ochranné rukavice.

Riziko pomliaždenia počas opravy, údržby, riešenia problémov a servisu na ťažkých a pohybujúcich sa komponentoch

- Noste ochrannú obuv.
- Zaisťte ťažké komponenty proti pádu.
- Nesiahajte končatinami do pohybujúcich sa komponentov.







Riziko ohrozenia bezpečnosti/funkčnosti spotrebiča!





- Používajte len originálne náhradné diely.

Riziko poškodenia elektrostaticky citlivých komponentov (ESD)!

- Nedotýkajte sa modulov vrátane prípojok a vedení vodičov.

Nástroje a pomôcky

Označenie	Detaily	Snímky
Pomocný nástroj [15000155]	Nástroj na uvoľnenie plastových častí	
Skrutkovač Torx T20 s otvorom [00340764]	100 mm, pre skrutky s bezpečnostným čapom	
Momentový kľúč [15000441]	Momentový kľúč 20 – 100 Nm	
Plochý skrutkovač [00340854]	Čepeľ 3,5 mm x 0,6 mm x 100 mm, ochranná izolácia 1000 V AC	
Plochý skrutkovač [00340855]	Čepeľ 5,5 mm x 1,0 mm x 125 mm, ochranná izolácia 1 000 V AC	
Kliešte zahnuté, špicaté [00341269]	Dĺžka 200 mm	
Bočné štípacie kliešte [00342182]	Dĺžka: 200 mm	



Označenie	Detaily	Snímky
Kombinovaný kľúč [00340811]	Veľkosť kľúča 10°mm, M6	
Combination wrench [00340814]	Veľkosť kľúča 13°mm, M8	
Kombinovaný kľúč [00340817]	Veľkosť kľúča 17 mm, M10	
Kombinovaný kľúč [15000459]	Veľkosť kľúča 16°mm, M10	

4.1 Výmena pracovnej plochy

Špeciálne nástroje:

-  Bit Torx TX20 s otvorom, dlhý 6,3°mm (1/4") 152°mm, pre skrutky s [00341272] bezpečnostným čapom

Požiadavka:

-  Spotrebič je odpojený od elektrického napájania.
-  Spotrebič je odpojený od zdroja vody.

4.1.1 Odoberanie pracovnej plochy

- ▶ 1. Odstráňte skrutky (1).
- ▶ 2. Zatlačte pracovnú plochu do zadnej časti spotrebiča (2).
- ▶ 3. Odstráňte pracovnú plochu posunutím nahor (3).

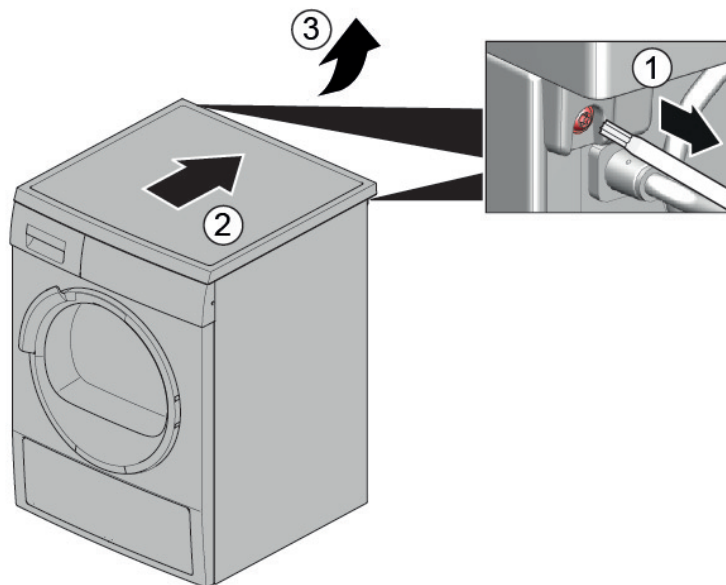

4.1.2 Montáž pracovnej plochy

- ▶ Pri montáži postupujte v opačnom poradí krokov demontáže.

4.2 Výmena panelu obloženia



UPOZORNENIE

Ostré hrany plášťa!
Rezné poranenia
▶ Noste ochranné rukavice.



VAROVANIE

Zošmyknutie naklonených spotrebičov!
Zlomeniny/pomliaždenia
▶ Zaistite spotrebiče proti zošmyknutiu.



UPOZORNENIE

Riziko pádu dielov po uvoľnení skrutiek!
Zranenie padajúcimi dielmi.
▶ Zaistite komponent proti pádu.



POZOR!

Riziko pádu dielov po uvoľnení skrutiek!
Poškodenie iných častí spotrebiča alebo domácnosti zákazníka, napr. podlahy.
▶ Zaistite komponent proti pádu.

Požiadavka:

- ✔ Spotrebič je odpojený od elektrického napájania.
- ✔ Spotrebič je odpojený od zdroja vody.
- ✔ [Pracovná plocha bola odobratá.→425](#)
- ✔ [Zásuvka na prací prostriedok bola odobratá.→427](#)

4.2.1 Odstránenie panelu obloženia

1. 1. Odstráňte skrutky (1).
2. 2. Uvoľnite zachytávacie prvky (2, 3).

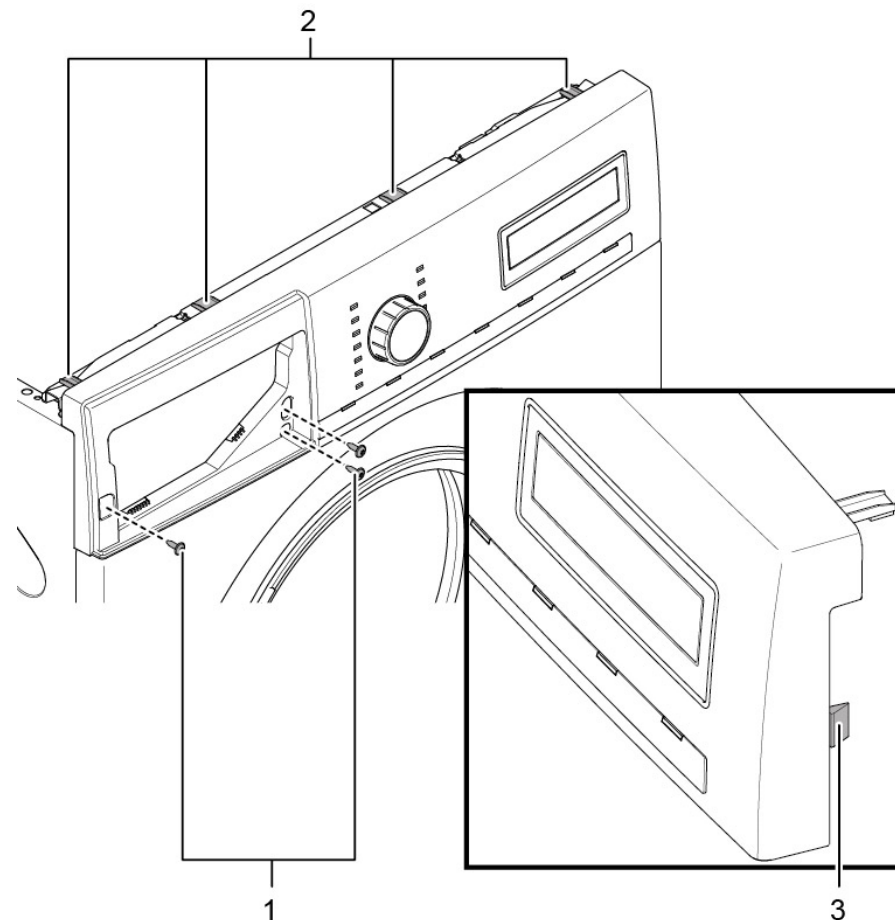

2. Uvoľnite kontakt zástrčky riadiacej jednotky.
3. Odoberte panel obloženia.

4.2.2 Montáž panelu obloženia

- ▶ Pri montáži postupujte v opačnom poradí krokov demontáže.

4.3 Výmena zásuvky na prací prostriedok

Požiadavka:

- ✔ Spotrebič je odpojený od elektrického napájania.
- ✔ Spotrebič je odpojený od zdroja vody.

4.3.1 Odstránenie zásuvky na prací prostriedok

1. Vytiahnite zásuvku na prací prostriedok.
2. 1. Zatlačte na vložku (1).
2. Odoberte zásuvku na prací prostriedok (2).

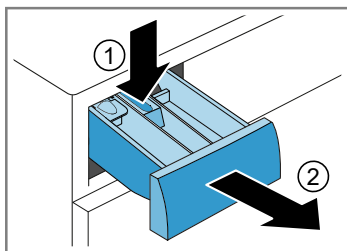

4.3.2 Montáž zásuvky na prací prostriedok

- ▶ Pri montáži postupujte v opačnom poradí krokov demontáže.

4.4 Výmena držadla zásuvky na prací prostriedok

Požiadavka:

- ✔ Spotrebič je odpojený od elektrického napájania.
- ✔ Spotrebič je odpojený od zdroja vody.
- ✔ [Zásuvka na prací prostriedok bola odobratá.→427](#)

4.4.1 Odstránenie držadla zásuvky na prací prostriedok

1. Uvoľnite zachytávacie prvky.

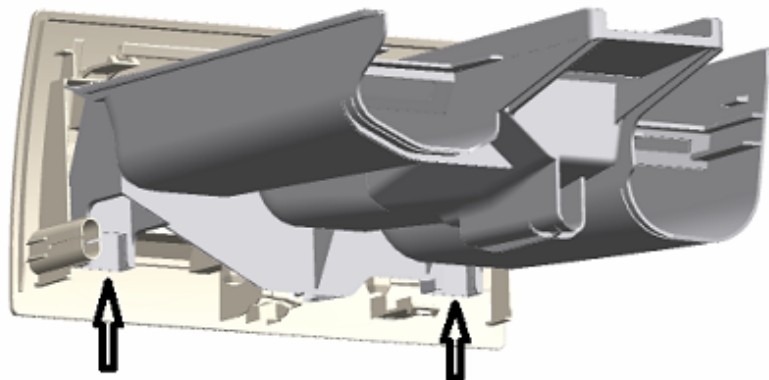

2. Odoberte držadlo zásuvky na prací prostriedok.

4.4.2 Montáž držadla zásuvky na prací prostriedok

- ▶ Pri montáži postupujte v opačnom poradí krokov demontáže.

4.5 Výmena dverí



UPOZORNENIE

Otvorte oblasť závesov!

Pomliaždenie/zachytenie prstov

- ▶ Nesiahajte do priestoru závesov.
- ▶ Noste ochranné rukavice.

Požiadavka:

- ✔ Spotrebič je odpojený od elektrického napájania.
- ✔ Spotrebič je odpojený od zdroja vody.
- ✔ Dvere sú otvorené.

4.5.1 Odoberanie dverí

1.



POZOR!

Riziko pádu dielov po uvoľnení skrutiek!

Poškodenie iných častí spotrebiča alebo domácnosti zákazníka, na pr. podlahy.

- ▶ Zaisťte komponent proti pádu.



UPOZORNENIE

Riziko pádu dielov po uvoľnení skrutiek!

Zranenie padajúcimi dielmi.

- ▶ Zaisťte komponent proti pádu.

Odstráňte skrutky (1).

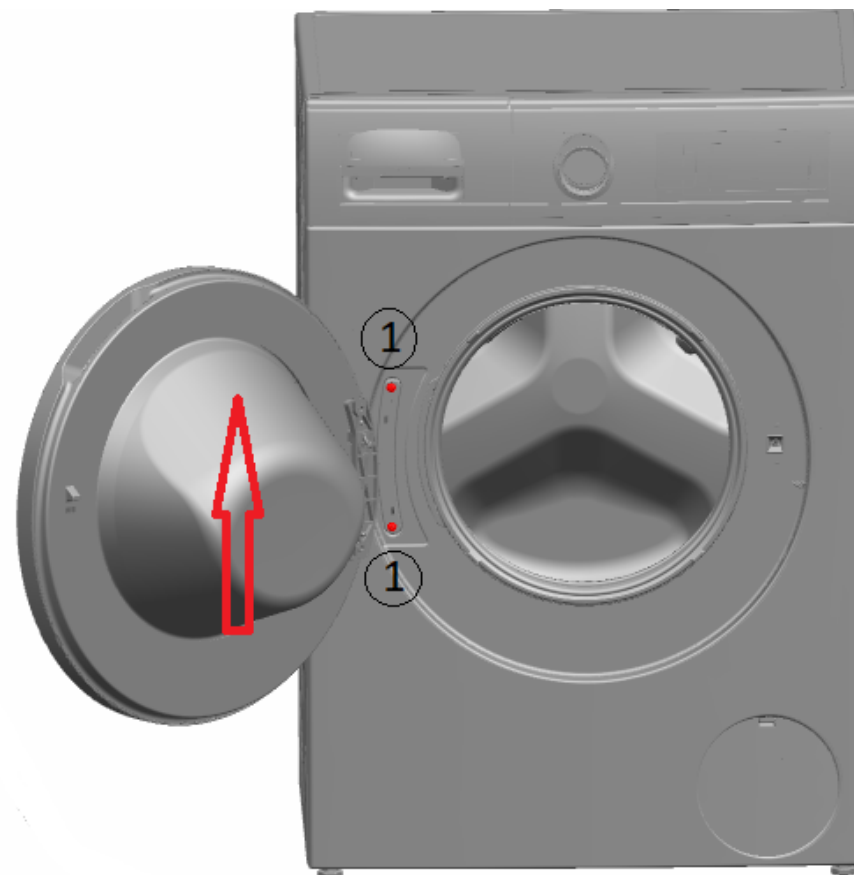

2. Odoberte dvere smerom nahor.

4.5.2 Montáž dverí

- ▶ Pri montáži postupujte v opačnom poradí krokov demontáže.

4.6 Výmena komponentov dverí



UPOZORNENIE

Otvorte oblasť závesov!

Pomliaždenie/zachytenie prstov

- ▶ Nesiahajte do priestoru závesov.
- ▶ Noste ochranné rukavice.

Požiadavka:

- ✔ Spotrebič je odpojený od elektrického napájania.
- ✔ Spotrebič je odpojený od zdroja vody.
- ✔ [Dvere boli odobraté.→429](#)

4.6.1 Odoberanie komponentov dverí

- ▶ Odmontujte dvere zvonku do vnútra.

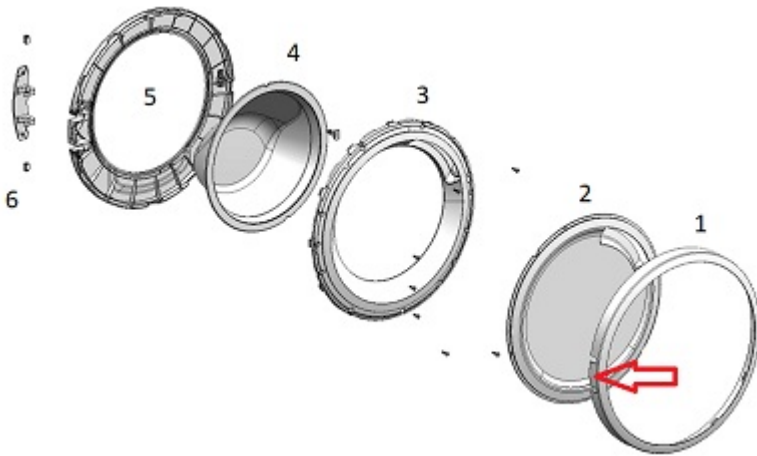

4.6.2 Montáž komponentov dverí

- ▶ Pri montáži postupujte v opačnom poradí krokov demontáže.

4.7 Výmena tesnenia dverí



UPOZORNENIE

Ostré hrany plášt'a!
Rezné poranenia
▶ Noste ochranné rukavice.



UPOZORNENIE

Riziko pádu dielov po uvoľnení skrutiek!
Zranenie padajúcimi dielmi.
▶ Zaisťte komponent proti pádu.



POZOR!

Riziko pádu dielov po uvoľnení skrutiek!
Poškodenie iných častí spotrebiča alebo domácnosti zákazníka, napr. podlahy.
▶ Zaisťte komponent proti pádu.

Požiadavka:

- ✓ Spotrebič je odpojený od elektrického napájania.
- ✓ Spotrebič je odpojený od zdroja vody.
- ✓ [Zásuvka na prací prostriedok bola odobratá.→427](#)
- ✓ [Dvere boli odobraté.→429](#)
- ✓ [Kryt čerpadla bol odobratý.→438](#)

4.7.1 Odoberanie tesnenia dverí

1.



VAROVANIE

Zošmyknutie naklonených spotrebičov!
Zlomeniny/pomliaždenia
▶ Zaisťte spotrebiče proti zošmyknutiu.

Nadvihnite spotrebič v prednej časti.

2. Uvoľnite skrutky na spodku čelného panela (1).

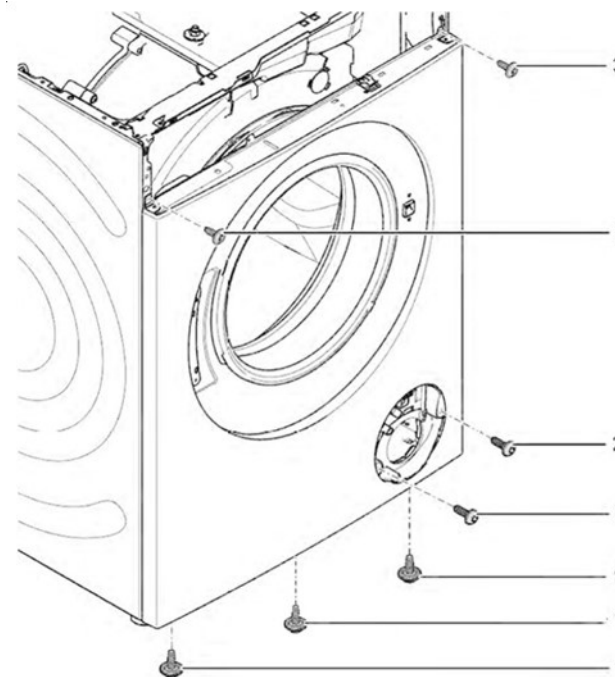

3. Zložte spotrebič na podlahu.

4. Odstráňte skrutky v priestore čerpadla (2).

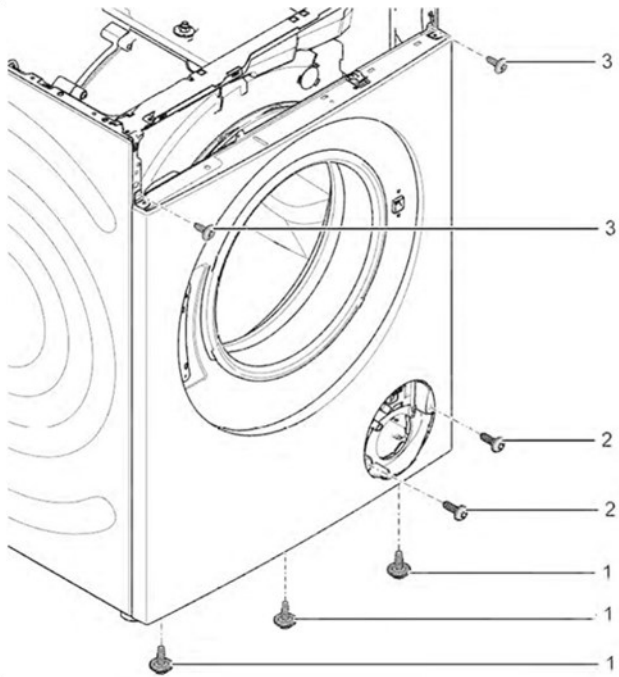

5. 1. Uvoľnite skrutky v zadnej časti spotrebiča (1).
2. Odstráňte pracovnú plochu (2, 3).

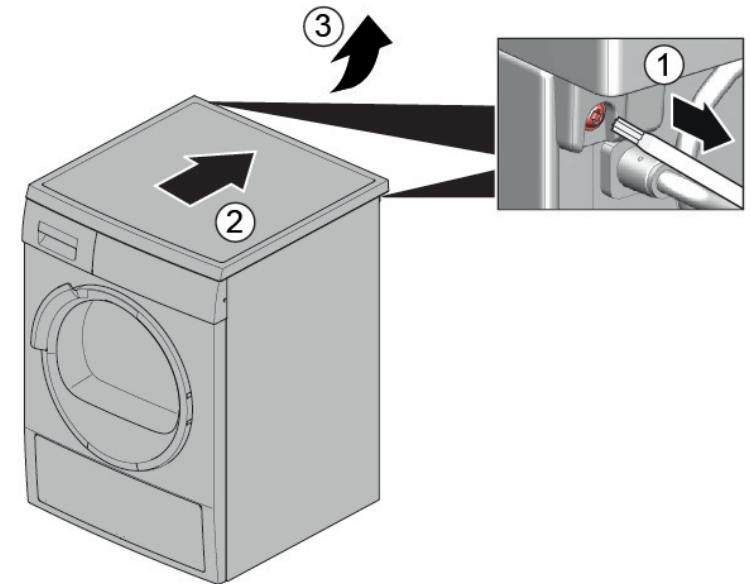

6. 1. Odstráňte skrutky (1).
2. Uvoľnite zachytávacie prvky čelného panela (2, 3).
3. Uvoľnite skrutky plášťa dávkovača.

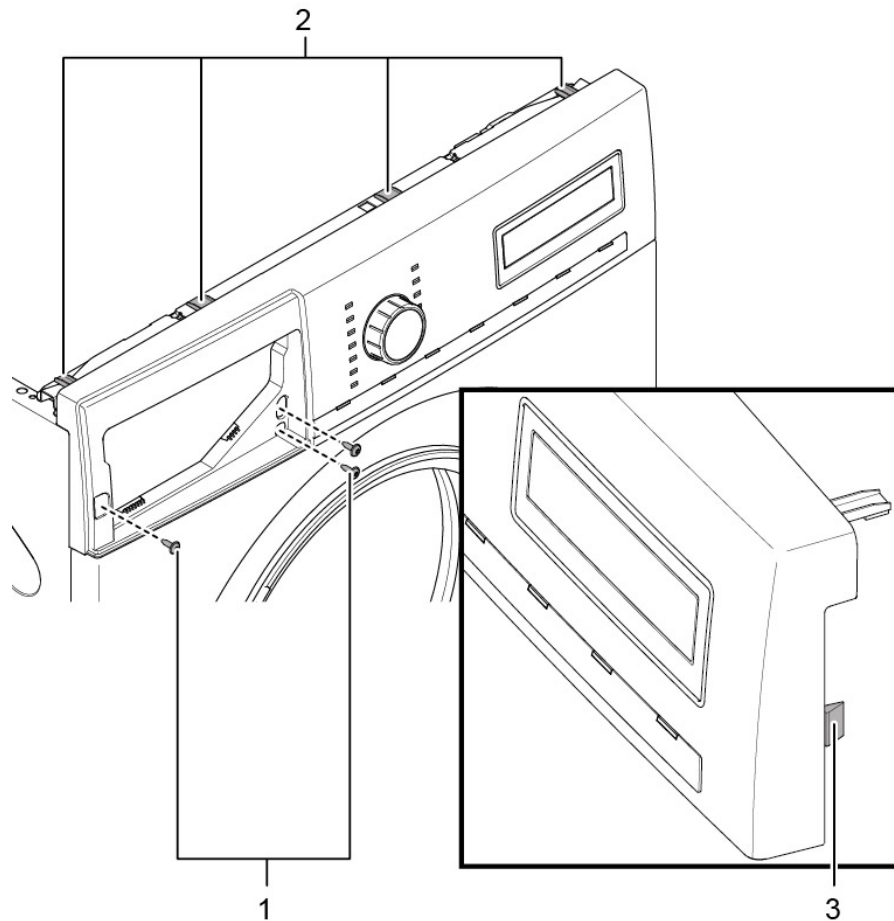

7. Odoberte panel obloženia.

8. Odstráňte držiak osvetlenia bubna v hornej časti.

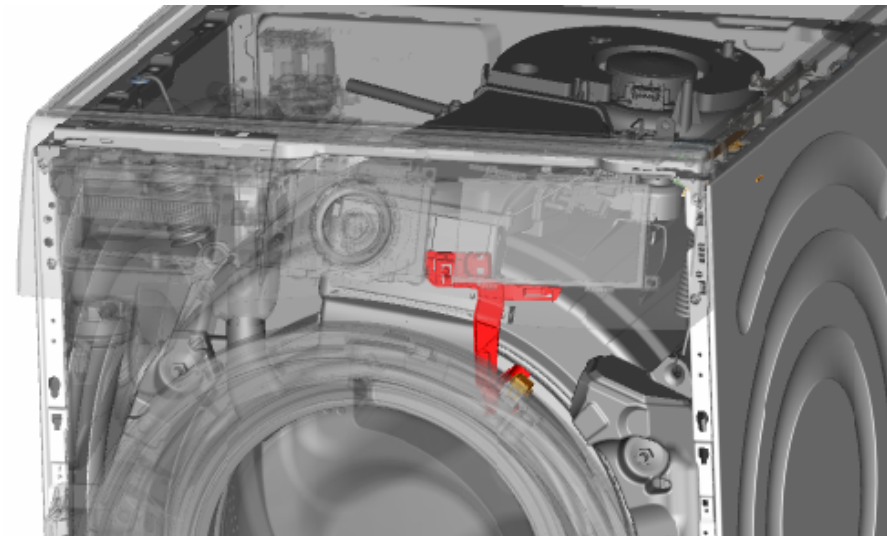

- 9.



POZOR!

Riziko poškodenia povrchu!

Použitím nesprávnych nástrojov sa povrch spotrebiča môže poškriabať.

- ▶ Na výmenu napínacieho krúžka použite len plastové nástroje.

Odoberte napínací krúžok z tesnenia použitím plastového nástroja.

10. Uvoľnite tesnenie dverí z čelného panela.
11. Uvoľnite káblovú prípojku z poistky dvierok.

12. Uvoľnite skrutky v hornej časti čelného panela (3).

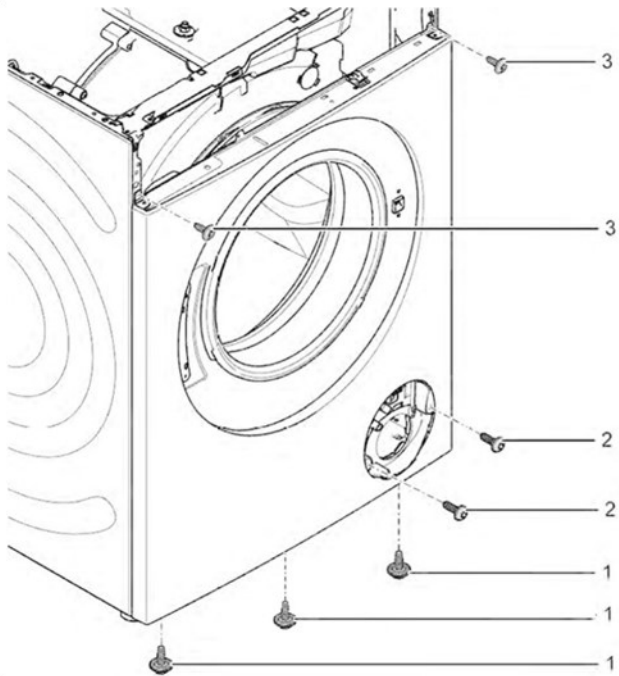

13. Odoberte čelný panel.

14. Uvoľnite všetky hadicové prípojky.

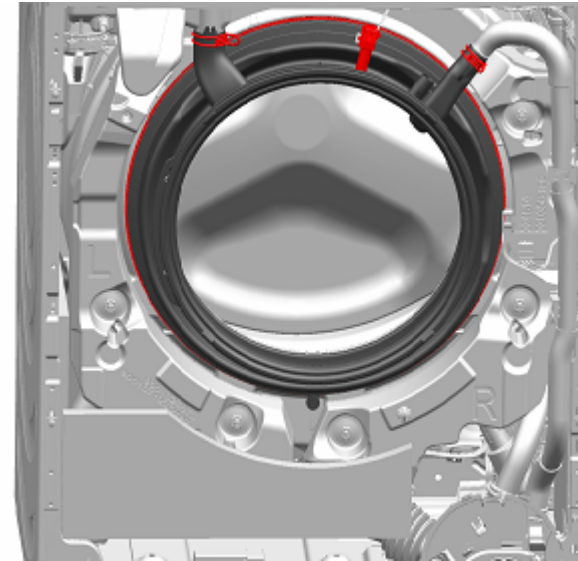

15. Odoberte tesnenie dverí.

4.7.2 Montáž tesnenia dverí



VAROVANIE

Riziko pádu dielov po nesprávnej inštalácii!

Zranenie alebo poškodenie spotrebiča.

- ▶ Pritiahnite napínací krúžok manžety do dverí práčky na 3,4 Nm.

- ▶ Pri montáži postupujte v opačnom poradí krokov demontáže.

4.8 Výmena poistky dvierok

Ako výrobca sme povinní poskytnúť zákazníkovi náhradný diel – poistka dvierok - vrátane pokynov k oprave v súlade s nariadením (EÚ) 2019/2023. Chceli by sme však podotknúť, že po výmene poistky dvierok sa pred uvedením spotrebiča do prevádzky vyžaduje test elektrotechnickej bezpečnosti, ktorý vykoná kvalifikovaný elektrikár. Kvalifikáciu tejto osoby musí byť možné overiť podľa miestnych zákonov, regulácií a nariadení.

	⚠ NEBEZPEČENSTVO
	<p>Nebezpečenstvo úrazu elektrickým prúdom pri dotyku s časťami pod napätím! Ohrozenie života spôsobené elektrickým zásahom v prípade nesprávnej opravy</p> <ul style="list-style-type: none"> ▶ Elektrické diely má opravovať kvalifikovaný elektrikár. ▶ Po oprave zariadenie vykonať bezpečnostný test v súlade s nariadením VDE 0701 alebo s miestnymi nariadeniami.

	⚠ UPOZORNENIE
	<p>Ostré hrany plášťa! Rezné poranenia</p> <ul style="list-style-type: none"> ▶ Noste ochranné rukavice.

	⚠ VAROVANIE
	<p>Zošmyknutie naklonených spotrebičov! Zlomeniny/pomliaždenia</p> <ul style="list-style-type: none"> ▶ Zaistíte spotrebiče proti zošmyknutiu.

	⚠ UPOZORNENIE
	<p>Riziko pádu dielov po uvoľnení skrutiek! Zranenie padajúcimi dielmi.</p> <ul style="list-style-type: none"> ▶ Zaistíte komponent proti pádu.

	POZOR!
	<p>Riziko pádu dielov po uvoľnení skrutiek! Poškodenie iných častí spotrebiča alebo domácnosti zákazníka, napr. podlahy.</p> <ul style="list-style-type: none"> ▶ Zaistíte komponent proti pádu.

Požiadavka:

- ✔ Spotrebič je odpojený od elektrického napájania.
- ✔ Spotrebič je odpojený od zdroja vody.
- ✔ Spotrebič je voľne dostupný.
- ✔ [Pracovná plocha bola odobratá. →425](#)
- ✔ Panel obloženia bol odobratý.
- ✔ [Dvere boli odobraté. →429](#)
- ✔ Napínací krúžok bol odobratý.
- ✔ Čelný panel bol odobratý.
- ✔ Tesnenie dverí boli odobraté.

4.8.1 Odoberanie poistky dvierok

1. Odpojte zástrčku poistky dvierok.
2. Uvoľnite poistku dvierok.



3. Odoberte poistku dvierok.

4.8.2 Montáž poistky dvierok

Poistka dvierok musí byť v správnej polohe, aby bola zabezpečená funkcia núdzového otvárania dvierok spotrebiča.



- ▶ Pri montáži postupujte v opačnom poradí krokov demontáže.

4.9 Výmena osvetlenia bubna



UPOZORNENIE

Ostré hrany plášťa!
Rezné poranenia
▶ Noste ochranné rukavice.



VAROVANIE

Zošmyknutie naklonených spotrebičov!
Zlomeniny/pomliaždenia
▶ Zaistite spotrebiče proti zošmyknutiu.



UPOZORNENIE







Riziko pádu dielov po uvoľnení skrutiek!
Zranenie padajúcimi dielmi.
▶ Zaistite komponent proti pádu.



POZOR!

Riziko pádu dielov po uvoľnení skrutiek!
Poškodenie iných častí spotrebiča alebo domácnosti zákazníka, napr. podlahy.
▶ Zaistite komponent proti pádu.

Požiadavka:

-  Spotrebič je odpojený od elektrického napájania.
-  Spotrebič je odpojený od zdroja vody.
-  Spotrebič je voľne dostupný.
-  [Pracovná plocha bola odobratá.→425](#)
-  [Zásuvka na prací prostriedok bola odobratá.→427](#)
-  Panel obloženia bol odobratý.

4.9.1 Odoberanie osvetlenia bubna

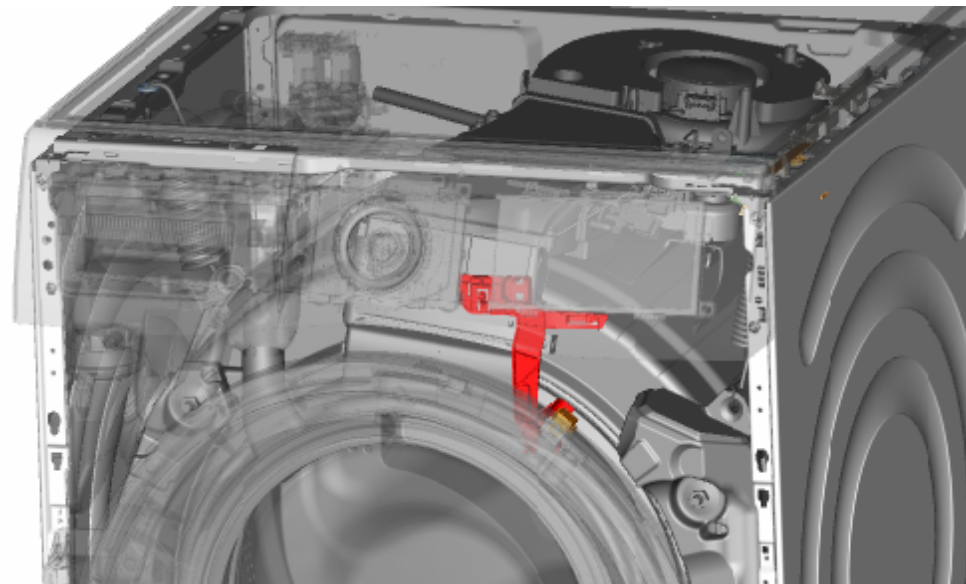

1. Vytiahnite držiak osvetlenia bubna spotrebiča.
2. Odpojte elektrické pripojenia.
3. Odoberte osvetlenie bubna z držiaka osvetlenia bubna.

4.9.2 Montáž osvetlenia bubna

- ▶ Pri montáži postupujte v opačnom poradí krokov demontáže.

4.10 Výmena krytu čerpadla

Požiadavka:

- ✔ Spotrebič je odpojený od elektrického napájania.
- ✔ Spotrebič je odpojený od zdroja vody.

4.10.1 Odoberanie krytu čerpadla

1. Otvorte kryt čerpadla.

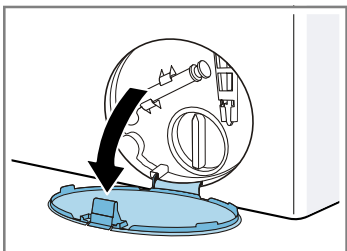

2. Odstráňte kryt čerpadla.

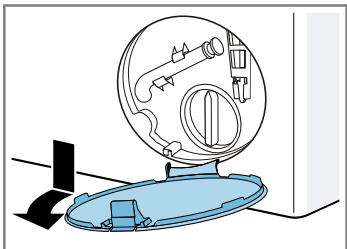

4.10.2 Montáž krytu čerpadla

- ▶ Pri montáži postupujte v opačnom poradí krokov demontáže.

4.11 Výmena čelného panela



UPOZORNENIE

Ostré hrany plášt'a!
Rezné poranenia
► Noste ochranné rukavice.

Požiadavka:

- ✔ Spotrebič je odpojený od elektrického napájania.
- ✔ Spotrebič je odpojený od zdroja vody.
- ✔ [Zásuvka na prací prostriedok bola odobratá.→427](#)
- ✔ [Dvere boli odobraté.→429](#)
- ✔ Tesnenie dverí boli odobraté.
- ✔ [Kryt čerpadla bol odobratý.→438](#)

4.11.1 Odstránenie čelného panela

1.



VAROVANIE

Zošmyknutie naklonených spotrebičov!
Zlomeniny/pomliaždenia
► Zaisťte spotrebiče proti zošmyknutiu.

Nadvihnite spotrebič v prednej časti.

2. Odstráňte skrutky v spodnej časti (1).

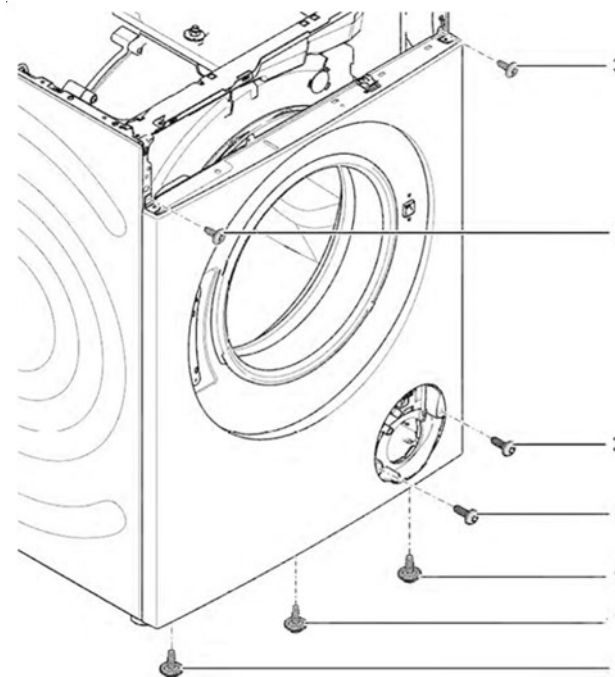

3. Zložte spotrebič na podlahu.

Oprava

4. 1. Odstráňte skrutky (1).
2. Zatlačte pracovnú plochu do zadnej časti spotrebiča (2).
3. Odstráňte pracovnú plochu posunutím nahor (3).

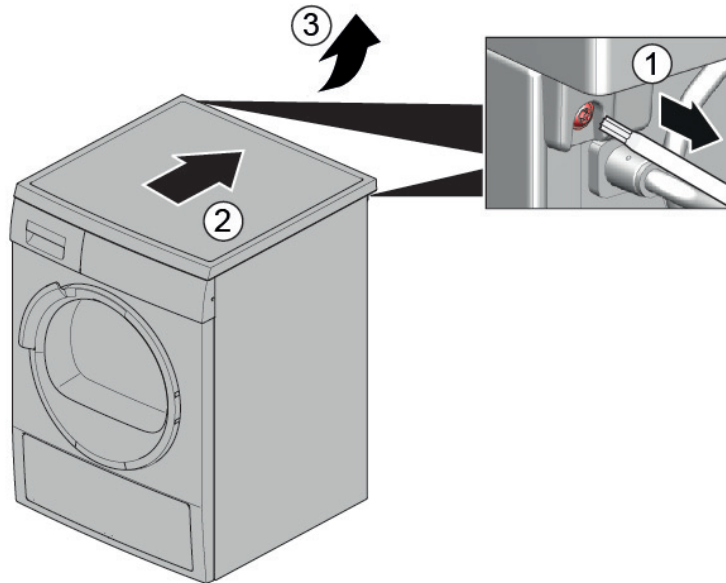

5. 1. Odstráňte skrutky (1).
2. Uvoľnite zachytávacie prvky (2, 3).

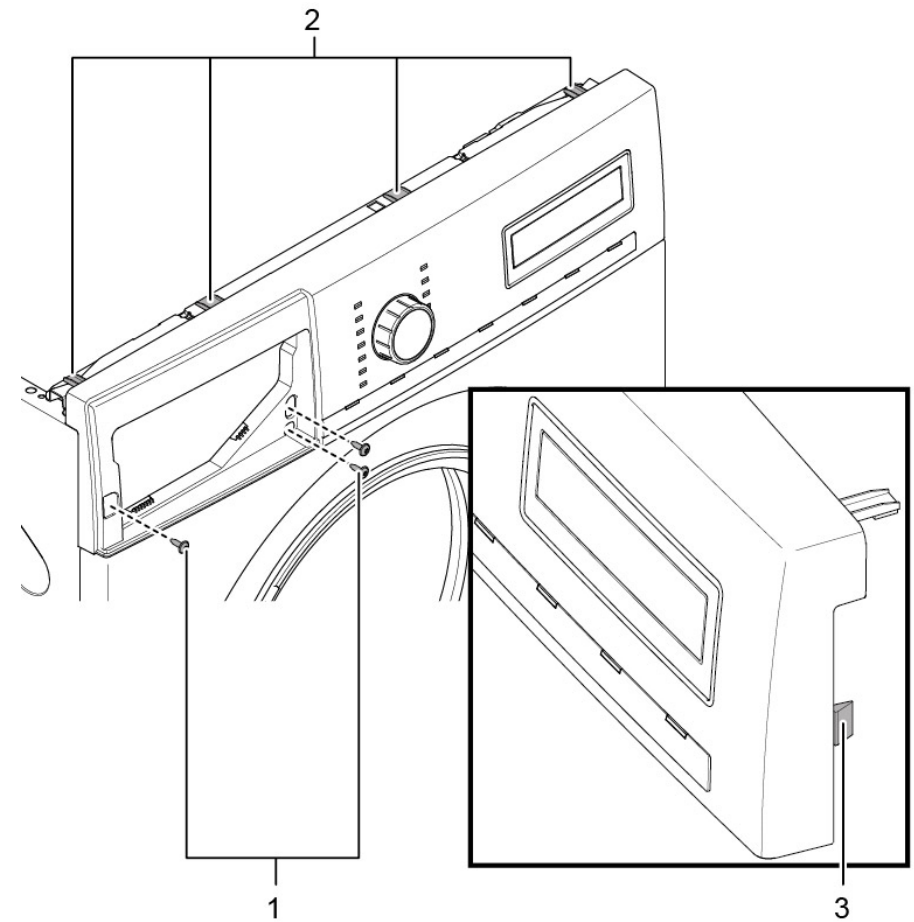

6. Odoberte panel obloženia.

7.



UPOZORNENIE

Riziko pádu dielov po uvoľnení skrutiek!
Zranenie padajúcimi dielmi.
► Zaistite komponent proti pádu.



POZOR!

Riziko pádu dielov po uvoľnení skrutiek!

Poškodenie iných častí spotrebiča alebo domácnosti zákazníka, napr. podlahy.

- ▶ Zaisťujte komponenty proti pádu.

Odstráňte skrutky v prednej časti zospodu nahor (2, 3).

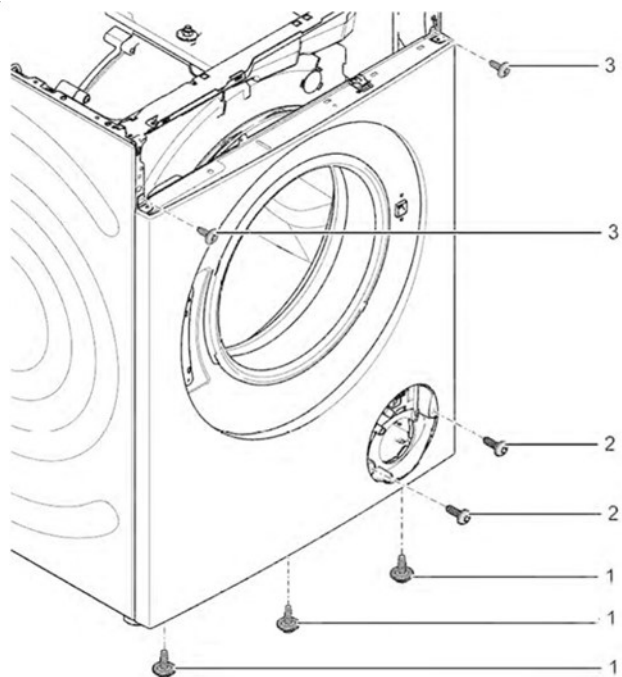

8. Odoberte čelný panel.

4.11.2 Montáž čelného panela

- ▶ Pri montáži postupujte v opačnom poradí krokov demontáže.

Nasveti za popravilo - Pralni stroj

 V zvezi s tem dokumentom	443
1.1 Pomembne informacije	443
1.1.1 Namen	443
1.2 Razlaga simbolov	443
1.2.1 Stopnje nevarnosti	443
1.2.2 Simboli za nevarnost	443
1.2.3 Struktura opozoril	444
1.2.4 Splošni simboli	444
 Varnost	445
2.1 Splošna varnostna navodila	445
2.1.1 Vsi gospodinjski aparati	445
 Orodja in pripomočki	446
 Popravilo	447
4.1 Zamenjava delovne površine	447
4.1.1 Odstranjevanje delovne površine	447
4.1.2 Namestitev delovne površine	447
4.2 Zamenjava plošče za vence	448
4.2.1 Odstranjevanje plošče za vence	448
4.2.2 Namestitev plošče za vence	448
4.3 Zamenjava predalčka za detergent	449
4.3.1 Odstranjevanje predalčka za detergent	449
4.3.2 Namestitev predalčka za detergent	449
4.4 Zamenjava ročaja predalčka za detergent	450
4.4.1 Odstranjevanje ročaja predalčka za detergent	450
4.4.2 Namestitev ročaja predalčka za detergent	450
4.5 Zamenjava vrat	451
4.5.1 Odstranjevanje vrat	451
4.5.2 Namestitev vrat	451
4.6 Zamenjava komponent vrat	452
4.6.1 Odstranjevanje komponent vrat	452
4.6.2 Namestitev komponent vrat	452
4.7 Zamenjava tesnila vrat	453
4.7.1 Odstranjevanje tesnila vrat	453
4.7.2 Namestitev tesnila vrat	456

4.8 Zamenjava varovala vrat	457
4.8.1 Odstranjevanje varovala vrat	457
4.8.2 Namestitev varovala vrat	458
4.9 Zamenjava luči bobna	459
4.9.1 Odstranjevanje luči bobna	459
4.9.2 Namestitev luči bobna	459
4.10 Zamenjava pokrova črpalke	460
4.10.1 Odstranjevanje pokrova črpalke	460
4.10.2 Namestitev pokrova črpalke	460
4.11 Zamenjava sprednje plošče	461
4.11.1 Odstranjevanje sprednje plošče	461
4.11.2 Namestitev sprednje plošče	463

i V zvezi s tem dokumentom

1.1 Pomembne informacije

1.1.1 Namen

Ti namigi za popravila uporabnika podpirajo pri lastnoročnem popravilu aparatov skladno z veljavno direktivo glede okoljsko primerne zasnove (od marca 2021).

Vsebujejo informacije o tem, kako zamenjati določene rezervne dele, vključno z opozorili in tveganji.

Če imate kakšna vprašanja, se obrnite na našo servisno službo. Za škodo bomo odgovorni le, če ste namige za popravila upoštevali pravilno.

1.2 Razlaga simbolov

1.2.1 Stopnje nevarnosti

Stopnje opozoril so sestavljene iz simbola in signalne besede. Signalna beseda označuje stopnjo nevarnosti.





Stopnja opozorila	Pomen
 NEVARNOST	Neupoštevanje opozorilnega sporočila bo povzročilo smrt ali hude poškodbe.
 OPOZORILO	Neupoštevanje opozorilnega sporočila lahko povzroči smrt ali hude poškodbe.
 PREVIDNO	Neupoštevanje opozorilnega sporočila lahko povzroči manjše poškodbe.
POZOR!	Neupoštevanje opozorilnega sporočila lahko povzroči škodo na lastnini.

Preglednica 1: Stopnje nevarnosti



1.2.2 Simboli za nevarnost

Simboli za nevarnost so simbolni prikazi, ki podajajo informacije o vrsti nevarnosti.

V tem dokumentu so uporabljeni naslednji simboli za nevarnost:

Simbol za nevarnost	Pomen
	Splošno opozorilno sporočilo
	Nevarnost zaradi električne napetosti
	Nevarnost eksplozije
	Nevarnost ureznin
	Nevarnost zmečkanin

i V zvezi s tem dokumentom

Simbol za nevarnost	Pomen
	Nevarnost zaradi vročih površin
	Nevarnost zaradi močnega magnetnega polja
	Nevarnost zaradi neionizirajočega sevanja

Preglednica 2: Simboli za nevarnost

1.2.3 Struktura opozoril

Opozorila v tem dokumentu imajo standardiziran videz in standardizirano strukturo.



	<div style="background-color: red; color: white; padding: 2px; display: inline-block;">⚠ NEVARNOST</div> <p>Vrsta in vir nevarnosti! Morebitne posledice ob neupoštevanju nevarnosti/opozorila.</p> <ul style="list-style-type: none"> ▶ Ukrepi in prepovedi za preprečevanje nevarnosti.
--	--





V naslednjem primeru je prikazano opozorilo, ki opozarja pred električnim udarom zaradi delov pod napetostjo. Naveden je ukrep za preprečevanje nevarnosti.

	<div style="background-color: red; color: white; padding: 2px; display: inline-block;">⚠ NEVARNOST</div> <p>Nevarnost električnega udara zaradi delov pod napetostjo! Smrt zaradi električnega udara</p> <ul style="list-style-type: none"> ▶ Izključite aparate iz električnega omrežja vsaj 60 sekund pred začetkom popravil.
---	--

1.2.4 Splošni simboli

V tem dokumentu so uporabljeni naslednji splošni simboli:

Splošni simbol	Pomen
	Identifikacija posebnega nasveta (besedilo in/ali slika)
	Identifikacija preprostega nasveta (samo besedilo)
	Identifikacija povezave na video vadnico

Splošni simbol	Pomen
	Identifikacija potrebnih orodij
	Identifikacija potrebnih predpogojev
	Identifikacija pogoja (če ..., potem ...)
	Identifikacija rezultata
Začetek	Identifikacija tipke ali gumba
[00123456]	Identifikacija številke dela
Stanje	Identifikacija prikazanega besedila/okna (na zaslonu aparata)

Preglednica 3: Splošni simboli

2.1 Splošna varnostna navodila

2.1.1 Vsi gospodinjski aparati

Nevarnost električnega udara zaradi delov pod napetostjo!

- Napake zaradi popravil električnih komponent lahko povzročijo električni udar!
- Aparat izključite iz električnega omrežja vsaj 60 sekund pred začetkom del.
- Po popravilu je treba izvesti preizkus varnosti v skladu z VDE 0701 ali predpisi, ki veljajo za posamezno državo.

Nevarnost poškodb zaradi ostrih robov!

- Uporabljajte zaščitne rokavice.

Nevarnost zmečkanin med popravili, vzdrževanjem, odpravljanjem težav ali servisom zaradi težkih in premikajočih se komponent

- Uporabljajte zaščitne čevlje.
- Težke komponente zavarujte pred padanjem.
- Delov telesa ne vstavljajte v premikajoče se komponente.







Tveganje za varnost/delovanje aparata!





- Uporabljajte le originalne nadomestne dele.

Tveganje poškodb elektrostatično občutljivih komponent (ESD)!

- Ne dotikajte se modulov, vključno s povezavami in potmi vodnika.

Orodja in pripomočki

Oznaka	Podrobnosti	Slike
Pomožno orodje [15000155]	Orodje za rahljanje plastičnih delov	
Izvijač Torx T20 z izvrtino [00340764]	100 mm, za vijake z varnostnim zatičem	
Momentni ključ [15000441]	Momentni ključ 20–100 Nm	
Ploščati zvijač [00340854]	Steblo 3,5 mm x 0,6 mm x 100 mm, zaščitna izolacija 1000 V AC	
Ploščati zvijač [00340855]	Steblo 5,5 mm x 1,0 mm x 125 mm, zaščitna izolacija 1000 V AC	
Igličaste klešče, zakrivljene [00341269]	Dolžina 200 mm	
Klešče za bočno rezanje [00342182]	Dolžina: 200 mm	



Oznaka	Podrobnosti	Slike
Kombinirani ključ [00340811]	Velikost ključa 10°mm, M6	
Combination wrench [00340814]	Velikost ključa 13°mm, M8	
Kombinirani ključ [00340817]	Velikost ključa 17 mm, M10	
Kombinirani ključ [15000459]	Velikost ključa 16°mm, M10	

4.1 Zamenjava delovne površine

Posebna orodja:

-  Del Torx TX20 z odprtino, dolg 6,3°mm (1/4") 152°mm, za vijake z [00341272] varnostnim zatičem

Zahteva:

-  Aparat je odklopljen iz omrežne napetosti.
-  Aparat je odklopljen iz vira vode.

4.1.1 Odstranjevanje delovne površine

- ▶ 1. Odstranite vijake (1).
- ▶ 2. Potisnite delovno površino proti zadnjemu delu aparata (2).
- ▶ 3. Premaknite delovno površino navzgor (3), da jo odstranite.

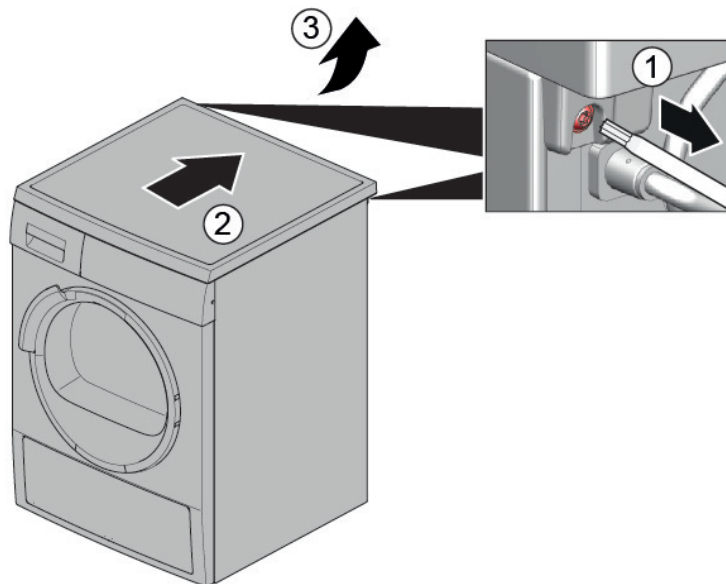

4.1.2 Namestitev delovne površine

- ▶ Namestite v obratnem vrstnem redu.

4.2 Zamenjava plošče za vence



⚠️ PREVIDNO

Ostri robovi ohišja!
Ureznine
▶ Uporabljajte zaščitne rokavice.



⚠️ OPOZORILO

Zdrs nagnjenih aparatov!
Zlomi kosti/zmečkanine
▶ Aparate zaščitite pred zdrsavanjem.



⚠️ PREVIDNO

Nevarnost padajočih delov zaradi zrahljanih vijakov!
Poškodbe zaradi padajočih delov.
▶ Komponento zaščitite pred padcem.



⚠️ POZOR!

Nevarnost padajočih delov zaradi zrahljanih vijakov!
Škoda na drugih delih aparata ali pri uporabniku doma, npr. na tleh.
▶ Komponento zaščitite pred padcem.

Zahteva:

- ✔ Aparat je odklopljen iz omrežne napetosti.
- ✔ Aparat je odklopljen iz vira vode.
- ✔ [Delovna površina je bila odstranjena.→447](#)
- ✔ [Predalček za detergent je bil odstranjen.→449](#)

4.2.1 Odstranjevanje plošče za vence

1. Odstranite vijake (1).
2. Sprostite držalne elemente (2, 3).

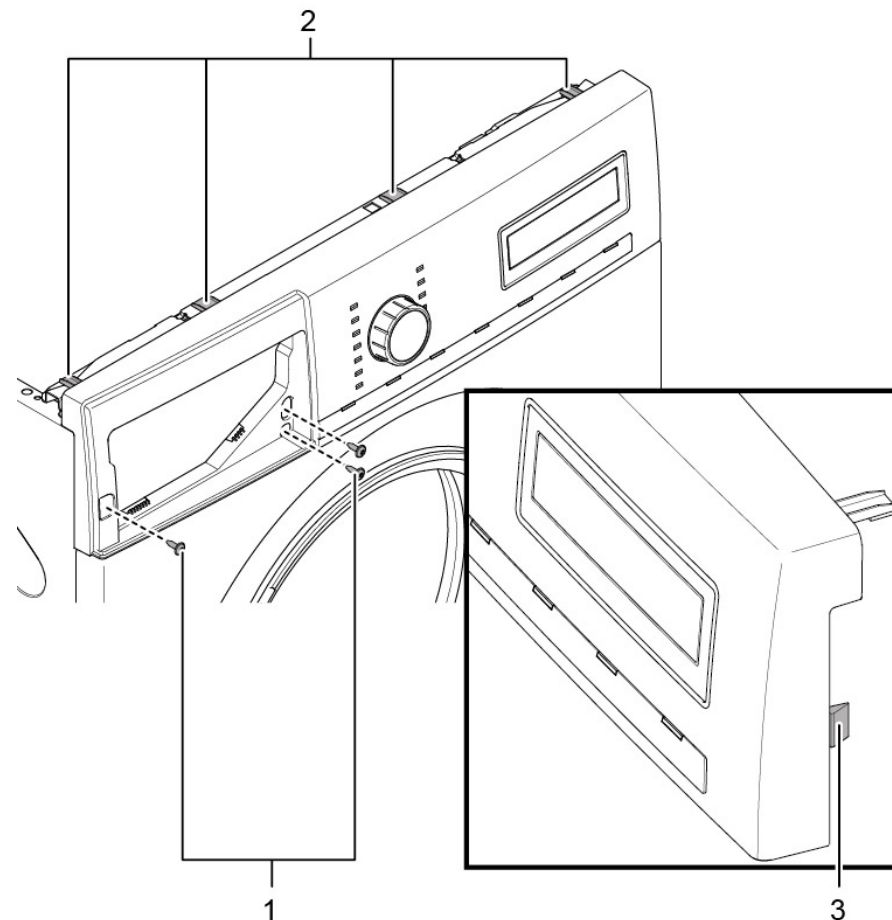

2. Sprostite vtični priključek krmilne enote.
3. Odstranite ploščo za vence.

4.2.2 Namestitev plošče za vence

- ▶ Namestite v obratnem vrstnem redu.

4.3 Zamenjava predalčka za detergent

Zahteva:

- ✓ Aparat je odklopljen iz omrežne napetosti.
- ✓ Aparat je odklopljen iz vira vode.

4.3.1 Odstranjevanje predalčka za detergent

1. Izvlecite predalček za detergent.
2. 1. Vstavek (1) potisnite navzdol.
2. Odstranite predalček za detergent (2).

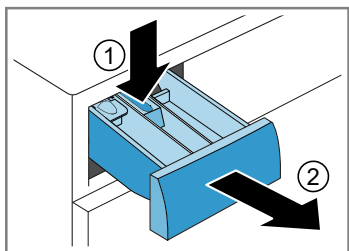

4.3.2 Namestitev predalčka za detergent

- ▶ Namestite v obratnem vrstnem redu.

4.4 Zamenjava ročaja predalčka za detergent

Zahteva:

- ✓ Aparat je odklopljen iz omrežne napetosti.
- ✓ Aparat je odklopljen iz vira vode.
- ✓ [Predalček za detergent je bil odstranjen.→449](#)

4.4.1 Odstranjevanje ročaja predalčka za detergent

1. Sprostite držalne elemente.

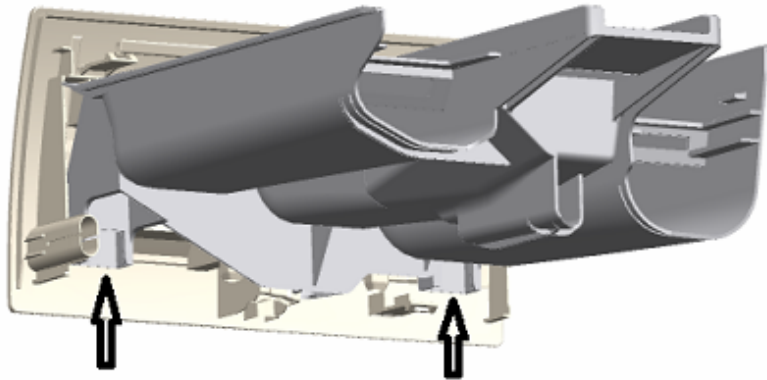

2. Odstranite ročaj predalčka za detergent.

4.4.2 Namestitev ročaja predalčka za detergent

- ▶ Namestite v obratnem vrstnem redu.

4.5 Zamenjava vrat



⚠️ PREVIDNO

Odprite območje tečaja!

Zmečkanine/zagozditev prstov

- ▶ Ne segajte v območje tečajev.
- ▶ Uporabljajte zaščitne rokavice.

Zahteva:

- ✔ Aparat je odklopljen iz omrežne napetosti.
- ✔ Aparat je odklopljen iz vira vode.
- ✔ Vrata so odprta.

4.5.1 Odstranjevanje vrat

1.



POZOR!

Nevarnost padajočih delov zaradi zrahljanih vijakov!

Škoda na drugih delih aparata ali pri uporabniku doma, npr. na tleh.

- ▶ Komponento zaščitite pred padcem.



⚠️ PREVIDNO

Nevarnost padajočih delov zaradi zrahljanih vijakov!

Poškodbe zaradi padajočih delov.

- ▶ Komponento zaščitite pred padcem.

Odstranite vijake (1).

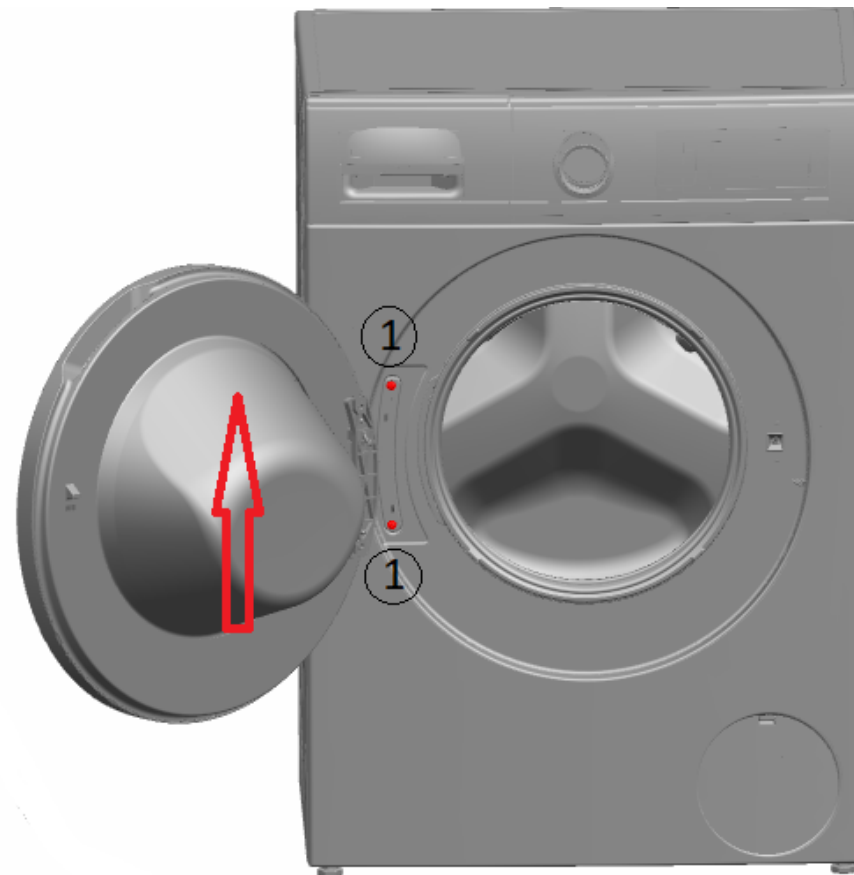

2. Odstranite vrata v smeri navzgor.

4.5.2 Namestitev vrat

- ▶ Namestite v obratnem vrstnem redu.

4.6 Zamenjava komponent vrat



PREVIDNO

Odprite območje tečaja!

Zmečkanine/zagozditev prstov

- ▶ Ne segajte v območje tečajev.
- ▶ Uporabljajte zaščitne rokavice.

Zahteva:

- ✓ Aparat je odklopljen iz omrežne napetosti.
- ✓ Aparat je odklopljen iz vira vode.
- ✓ [Vrata so bila odstranjena.→451](#)

4.6.1 Odstranjevanje komponent vrat

- ▶ Vrata razstavite od zunanje proti notranji strani.

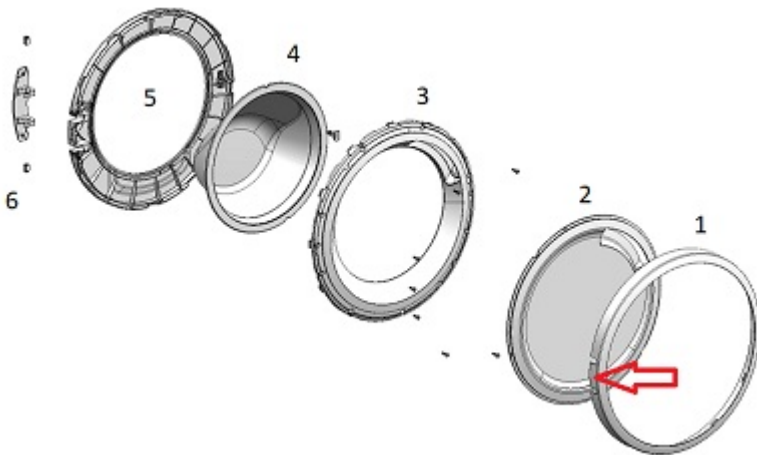

4.6.2 Namestitev komponent vrat

- ▶ Namestite v obratnem vrstnem redu.

4.7 Zamenjava tesnila vrat



⚠️ PREVIDNO

Ostri robovi ohišja!
Ureznine
▶ Uporabljajte zaščitne rokavice.



⚠️ PREVIDNO

Nevarnost padajočih delov zaradi zrahljanih vijakov!
Poškodbe zaradi padajočih delov.
▶ Komponento zaščitite pred padcem.



⚠️ POZORI!

Nevarnost padajočih delov zaradi zrahljanih vijakov!
Škoda na drugih delih aparata ali pri uporabniku doma, npr. na tleh.
▶ Komponento zaščitite pred padcem.

Zahteva:

- ✓ Aparat je odklopljen iz omrežne napetosti.
- ✓ Aparat je odklopljen iz vira vode.
- ✓ [Predalček za detergent je bil odstranjen.→449](#)
- ✓ [Vrata so bila odstranjena.→451](#)
- ✓ [Pokrov črpalke je bil odstranjen.→460](#)

4.7.1 Odstranjevanje tesnila vrat

1.



⚠️ OPOZORILO

Zdrs nagnjenih aparatov!
Zlomi kosti/zmečkanine
▶ Aparate zaščitite pred zdrsavanjem.

Dvignite sprednji del aparata.

2. Sprostite vijake na dnu sprednje plošče (1).

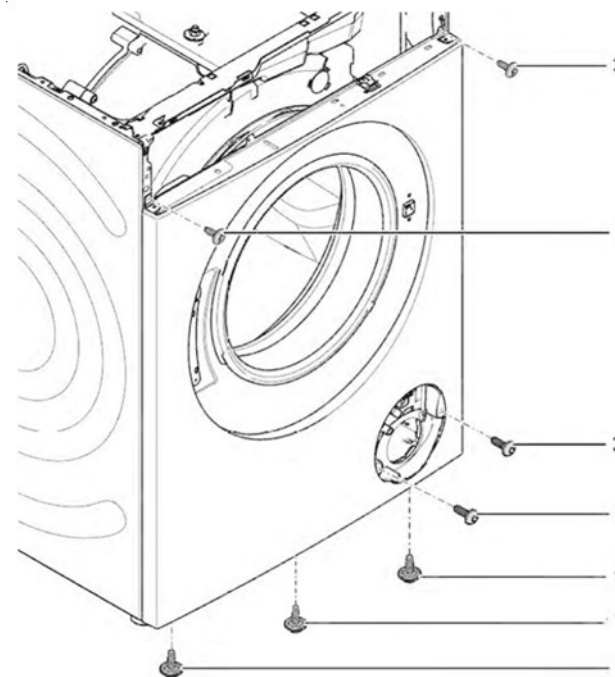

3. Spustite aparat.

Popravilo

4. Odstranite vijake na območju črpalke (2).

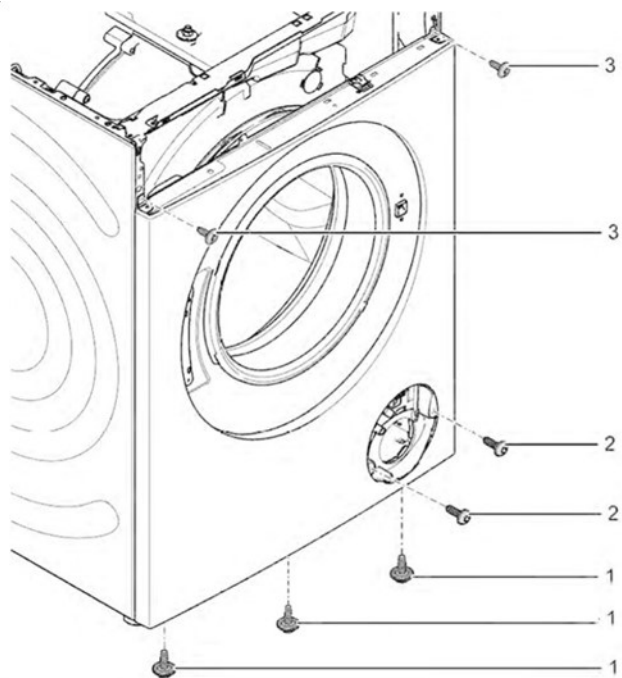

5. 1. Sprostite vijake na hrbtni strani aparata (1).
2. Odstranite delovno površino (2, 3).

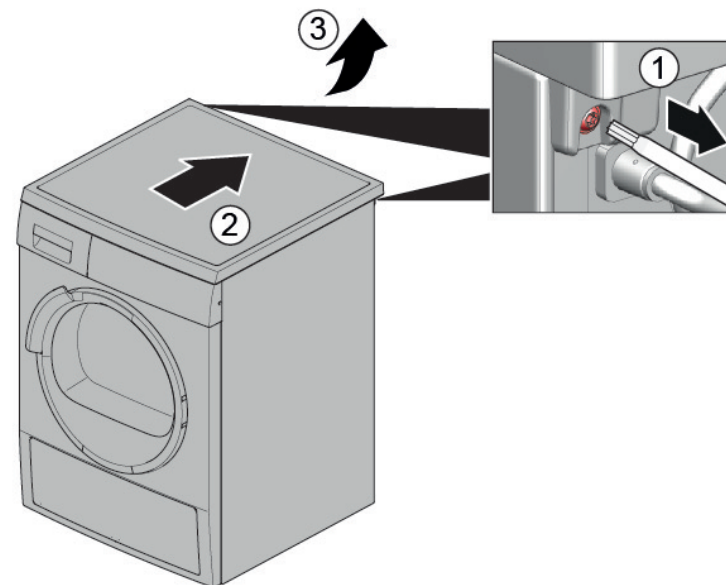

Popravilo

6. 1. Odstranite vijake (1).
2. Sprostite držalne elemente plošče za vence (2, 3).
3. Sprostite vijake na ohišju razdeljevalnika.

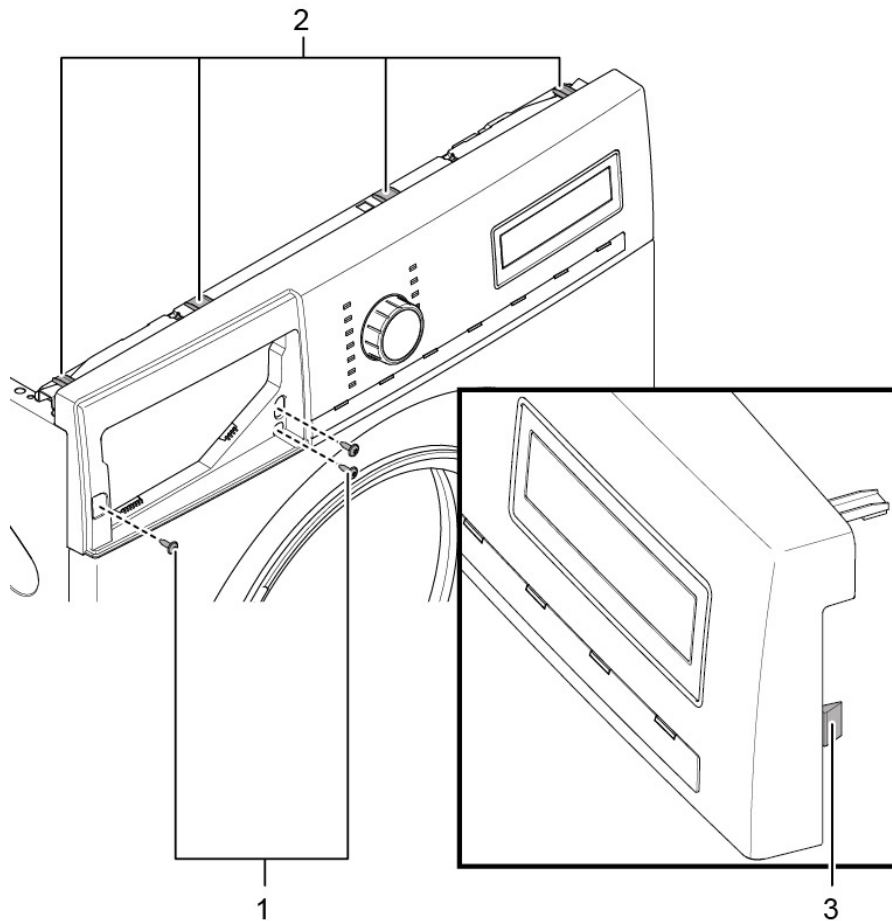

7. Odstranite ploščo za vence.

8. Odstranite držalo lučke bobna na vrhu.

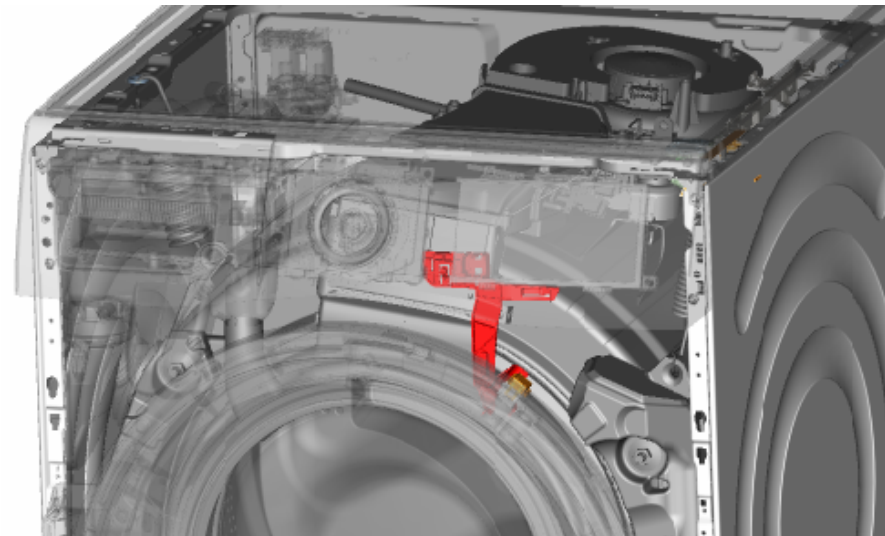

- 9.



POZOR!

Tveganje poškodb površine!

Površina aparata se lahko ob uporabi napačnih orodij poškoduje.

- Za zamenjavo obroča napenjalnika uporabljajte le plastična orodja.

S plastičnim orodjem odstranite obroč napenjalnika s tesnila.

10. Sprostite tesnilo vrat s sprednje plošče.
11. Sprostite priključek kabla z varovala vrat.

12. Sprostite vijake na vrhu sprednje plošče (3).

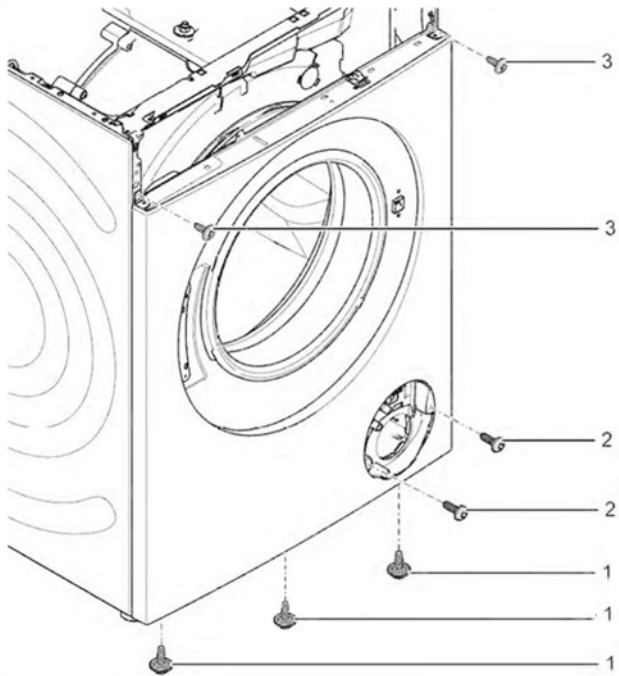

13. Odstranite sprednjo ploščo.

14. Sprostite vse priključke cevi.

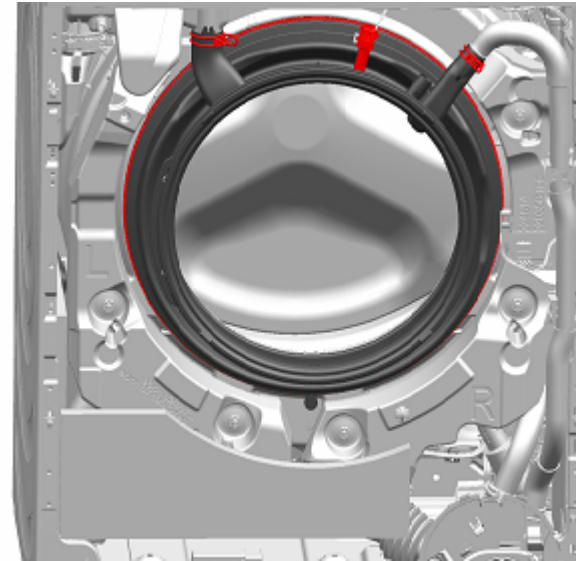

15. Odstranite tesnilo vrat.

4.7.2 Namestitev tesnila vrat



⚠ OPOZORILO

Nevarnost padajočih delov zaradi nepravilne namestitve!

Poškodba ali škoda na aparatu.

- ▶ Zategnite obroč napenjalnika tesnila vrat z zateznim momentom 3,4 Nm.

- ▶ Namestite v obratnem vrstnem redu.

4.8 Zamenjava varovala vrat

Kot proizvajalec moramo potrošnikom zagotoviti nadomestno varovalo vrat vklj. z navodili za uporabo v skladu z direktivo (EU) 2019/2023. Vendar želimo izpostaviti, da je po zamenjavi varovala vrat potreben preizkus elektrotehnične varnosti s strani kvalificiranega električarja, preden začnete z uporabo naprave. Ta oseba mora biti preverljivo kvalificirana v skladu z zakoni, predpisi in standardi, ki veljajo za posamezno državo.

	<p>NEVARNOST</p> <p>Nevarnost električnega udara zaradi delov pod napetostjo! Življenjska nevarnost zaradi električnega udara v primeru nepravilnega popravila</p> <ul style="list-style-type: none">▶ Električne dele mora popraviti kvalificiran električar.▶ Po popravilu je treba izvesti preizkus varnosti v skladu z VDE 0701 ali predpisi, ki veljajo za posamezno državo.
	<p>PREVIDNO</p> <p>Ostri robovi ohišja! Ureznine</p> <ul style="list-style-type: none">▶ Uporabljajte zaščitne rokavice.
	<p>OPOZORILO</p> <p>Zdrs nagnjenih aparatov! Zlomi kosti/zmečkanine</p> <ul style="list-style-type: none">▶ Aparate zaščitite pred zdrsavanjem.
	<p>PREVIDNO</p> <p>Nevarnost padajočih delov zaradi zrahljanih vijakov! Poškodbe zaradi padajočih delov.</p> <ul style="list-style-type: none">▶ Komponento zaščitite pred padcem.
	<p>POZOR!</p> <p>Nevarnost padajočih delov zaradi zrahljanih vijakov! Škoda na drugih delih aparata ali pri uporabniku doma, npr. na tleh.</p> <ul style="list-style-type: none">▶ Komponento zaščitite pred padcem.

Zahteva:

- ✓ Aparat je odklopljen iz omrežne napetosti.
- ✓ Aparat je odklopljen iz vira vode.

- ✓ Aparat je prosto dostopen.
- ✓ [Delovna površina je bila odstranjena.→447](#)
- ✓ Plošča za vence je bila odstranjena.
- ✓ [Vrata so bila odstranjena.→451](#)
- ✓ Obroč napenjalnika je bil odstranjen.
- ✓ Sprednja plošča je bila odstranjena.
- ✓ Tesnilo vrat je bilo odstranjeno.

4.8.1 Odstranjevanje varovala vrat

1. Odklopite vtič varovala vrat.
2. Sprostite varovalo vrat.



3. Odstranite varovalo vrat.

4.8.2 Namestitev varovala vrat

Varovalo vrat mora biti v pravilnem položaju, da na aparatu zagotovite delovanje funkcije odpiranja vrat v sili.

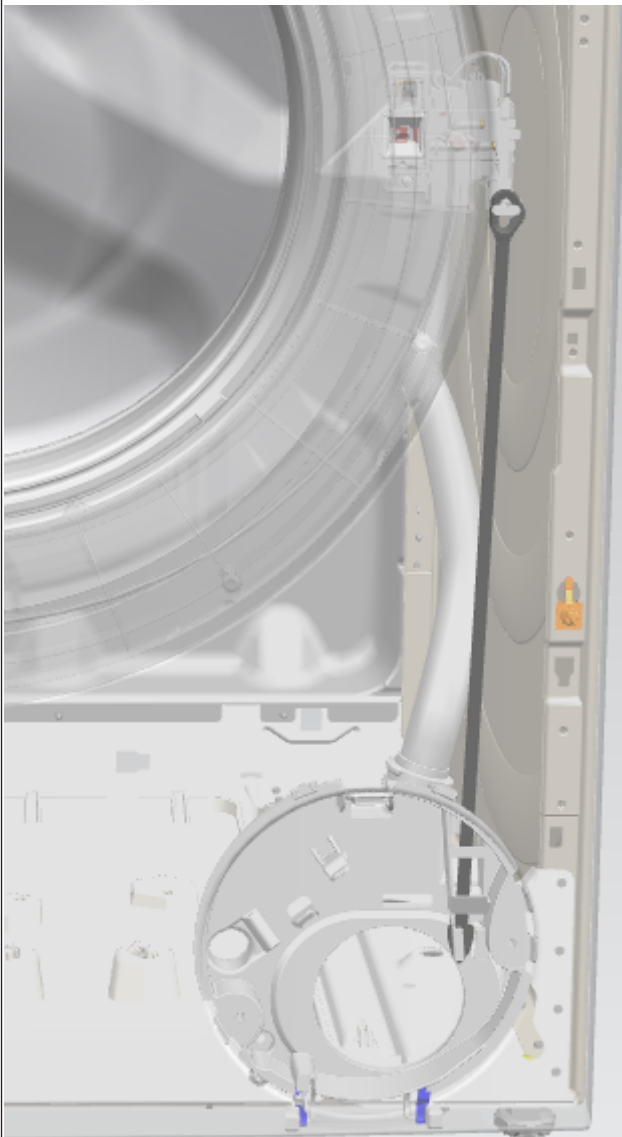

- ▶ Namestite v obratnem vrstnem redu.

4.9 Zamenjava luči bobna



⚠️ PREVIDNO

Ostri robovi ohišja!
Ureznine
▶ Uporabljajte zaščitne rokavice.



⚠️ OPOZORILO

Zdrs nagnjenih aparatov!
Zlomi kosti/zmečkanine
▶ Aparate zaščitite pred zdrsavanjem.



⚠️ PREVIDNO

Nevarnost padajočih delov zaradi zrahljanih vijakov!
Poškodbe zaradi padajočih delov.
▶ Komponento zaščitite pred padcem.



⚠️ POZOR!

Nevarnost padajočih delov zaradi zrahljanih vijakov!
Škoda na drugih delih aparata ali pri uporabniku doma, npr. na tleh.
▶ Komponento zaščitite pred padcem.

Zahteva:

- ✔ Aparat je odklopljen iz omrežne napetosti.
- ✔ Aparat je odklopljen iz vira vode.
- ✔ Aparat je prosto dostopen.
- ✔ [Delovna površina je bila odstranjena.→447](#)
- ✔ [Predalček za detergent je bil odstranjen.→449](#)
- ✔ Plošča za vence je bila odstranjena.

4.9.1 Odstranjevanje luči bobna

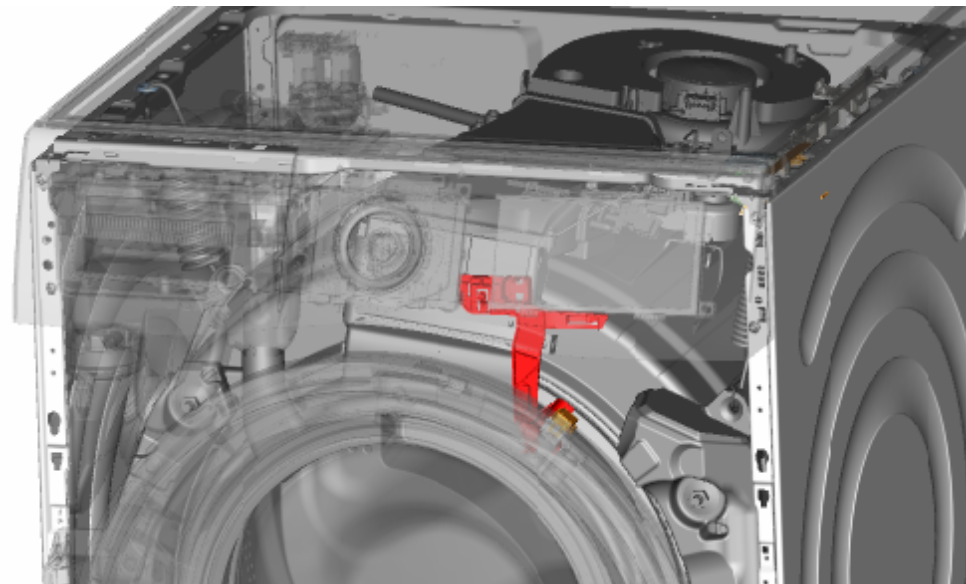

1. Izvlecite držalo luči bobna iz aparata.
2. Odklopite električne priključke.
3. Odstranite luč bobna z držala luči bobna.

4.9.2 Namestitev luči bobna

- ▶ Namestite v obratnem vrstnem redu.

4.10 Zamenjava pokrova črpalke

Zahteva:

- ✓ Aparat je odklopljen iz omrežne napetosti.
- ✓ Aparat je odklopljen iz vira vode.

4.10.1 Odstranjevanje pokrova črpalke

1. Odprite pokrov črpalke.

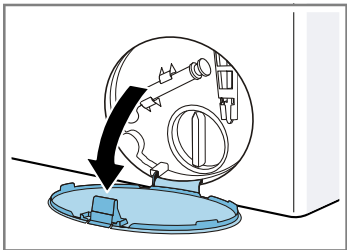

2. Odstranite pokrov črpalke.

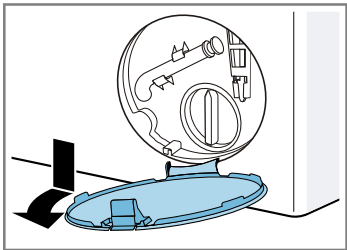

4.10.2 Namestitev pokrova črpalke

- ▶ Namestite v obratnem vrstnem redu.

4.11 Zamenjava sprednje plošče



⚠️ PREVIDNO

Ostri robovi ohišja!
Ureznine
▶ Uporabljajte zaščitne rokavice.

Zahteva:

- ✓ Aparat je odklopljen iz omrežne napetosti.
- ✓ Aparat je odklopljen iz vira vode.
- ✓ [Predalček za detergent je bil odstranjen.→449](#)
- ✓ [Vrata so bila odstranjena.→451](#)
- ✓ Tesnilo vrat je bilo odstranjeno.
- ✓ [Pokrov črpalke je bil odstranjen.→460](#)

4.11.1 Odstranjevanje sprednje plošče

1.



⚠️ OPOZORILO

Zdrs nagnjenih aparatov!
Zlomi kosti/zmečkanine
▶ Aparate zaščitite pred zdrsavanjem.

Dvignite sprednji del aparata.

2. Odstranite vijake na dnu (1).

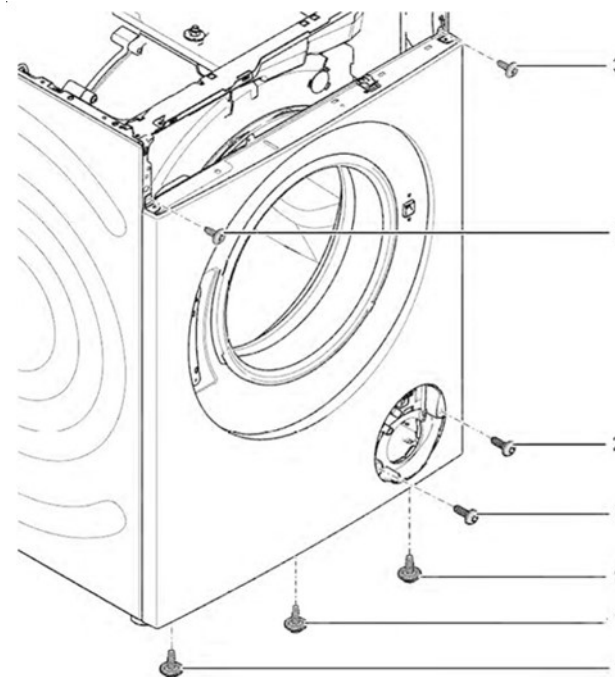

3. Spustite aparat.

Popravilo

4. 1. Odstranite vijake (1).
2. Potisnite delovno površino proti zadnjemu delu aparata (2).
3. Premaknite delovno površino navzgor (3), da jo odstranite.

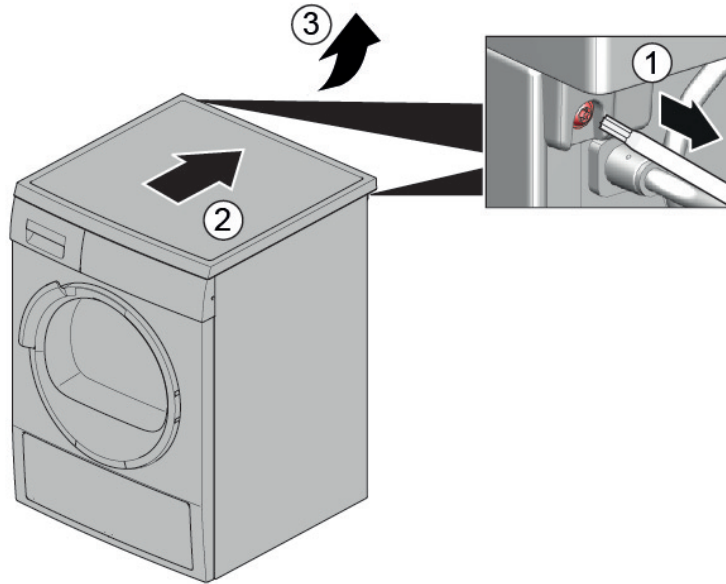

5. 1. Odstranite vijake (1).
2. Sprostite držalne elemente (2, 3).

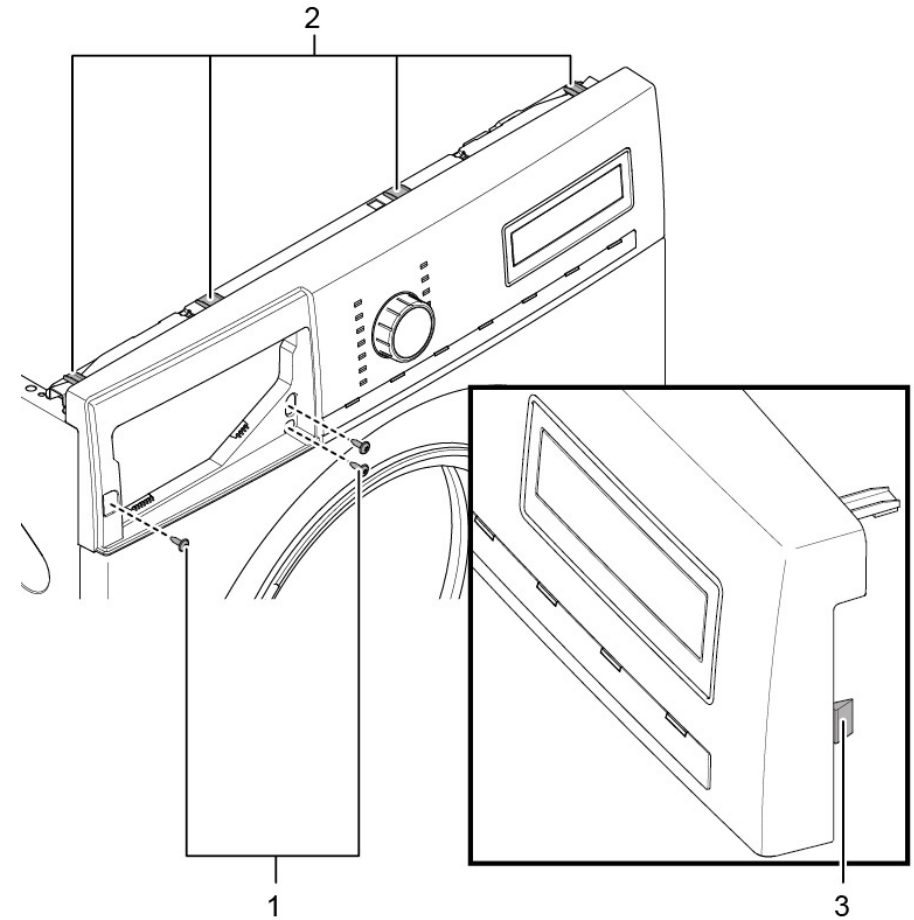

6. Odstranite ploščo za vence.

7.



PREVIDNO

Nevarnost padajočih delov zaradi zrahljanih vijakov!
Poškodbe zaradi padajočih delov.
► Komponento zaščitite pred padcem.



POZOR!

Nevarnost padajočih delov zaradi zrahljanih vijakov!

Škoda na drugih delih aparata ali pri uporabniku doma, npr. na tleh.

- ▶ Komponento zaščitite pred padcem.

Odstranite vijake na sprednji strani, pri čemer začnite od spodaj proti vrhu (2, 3).

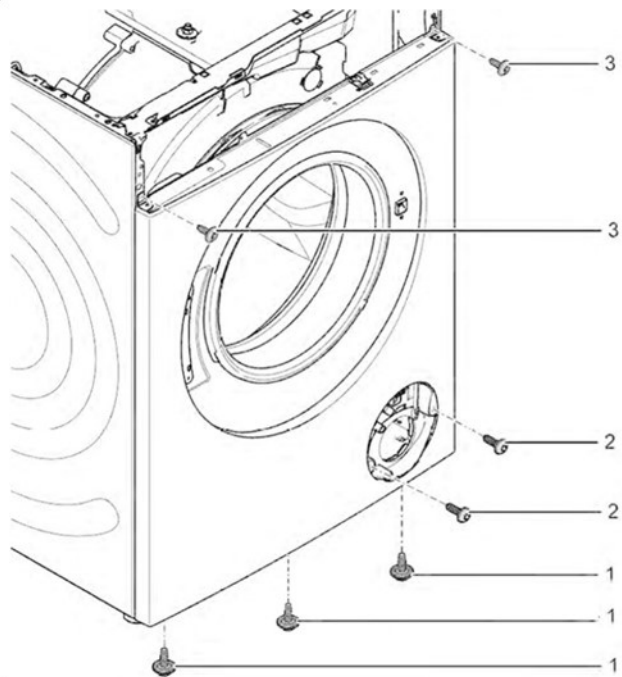

8. Odstranite sprednjo ploščo.

4.11.2 Namestitev sprednje plošče

- ▶ Namestite v obratnem vrstnem redu.

Consejos de reparación - Lavadora

En relación con este documento 465

1.1	Información importante	465
1.1.1	Finalidad	465
1.2	Explicación de símbolos generales	465
1.2.1	Niveles de peligrosidad	465
1.2.2	Símbolos de peligro	465
1.2.3	Estructura de las advertencias	466
1.2.4	Símbolos generales	466

Seguridad..... 467

2.1	Instrucciones generales de seguridad	467
2.1.1	Todos los aparatos electrodomésticos.....	467

Herramientas y auxiliares 468

Reparación 469

4.1	Sustituir la tapa superior	469
4.1.1	Desmontar la tapa superior.....	469
4.1.2	Montar la tapa superior.....	469
4.2	Sustituir el panel de control	470
4.2.1	Desmontar el panel de control	470
4.2.2	Montar el panel de control	470
4.3	Sustituir el compartimento para detergente	471
4.3.1	Desmontar el compartimento para detergente	471
4.3.2	Montar el compartimento para detergente	471
4.4	Sustituir el tirador del compartimento para detergente	472
4.4.1	Desmontar el tirador del compartimento para detergente.....	472
4.4.2	Montar el tirador del compartimento para detergente.....	472
4.5	Sustituir la puerta	473
4.5.1	Extraer la puerta	473
4.5.2	Montar la puerta.....	473
4.6	Sustituir los componentes de la puerta.....	474
4.6.1	Desmontar los componentes de la puerta.....	474
4.6.2	Montar los componentes de la puerta.....	474
4.7	Sustituir la junta de la puerta	475
4.7.1	Extraer la junta de la puerta	475
4.7.2	Montar la junta de la puerta	478

4.8	Sustituir el cierre de la puerta	479
4.8.1	Extraer el cierre de la puerta	479
4.8.2	Montar el cierre de la puerta.....	480
4.9	Sustituir la iluminación del tambor	481
4.9.1	Desmontar la iluminación del tambor	481
4.9.2	Montar la iluminación del tambor	481
4.10	Sustituir la tapa de la bomba.....	482
4.10.1	Retirar la tapa de la bomba	482
4.10.2	Montar la tapa de la bomba.....	482
4.11	Sustituir el panel frontal.....	483
4.11.1	Extraer el panel frontal.....	483
4.11.2	Montar el panel frontal	485

i En relación con este documento

1.1 Información importante

1.1.1 Finalidad

Estas indicaciones de reparación sirven como ayuda al consumidor para reparar aparatos por su cuenta conforme al reglamento aplicable sobre diseño ecológico (a partir de 03/2021).

Contienen información sobre cómo sustituir repuestos determinados e incluye las advertencias y los riesgos.

En caso de dudas, póngase en contacto con nuestro departamento de atención al cliente. Solo asumiremos la responsabilidad por daños si las indicaciones de reparación se han seguido correctamente.

1.2 Explicación de símbolos generales

1.2.1 Niveles de peligrosidad

Los niveles de peligro consisten en un símbolo y una palabra de advertencia. La palabra de advertencia identifica la gravedad del peligro.





Nivel de peligro	Significado
 PELIGRO	Si no se tiene en cuenta la advertencia, ocasionará la muerte o lesiones graves.
 ADVERTENCIA	Si no se tiene en cuenta la advertencia, puede ocasionar la muerte o lesiones graves.
 PRECAUCIÓN	Si no se tiene en cuenta la advertencia, puede ocasionar lesiones de carácter leve.
ATENCIÓN	Si no se tiene en cuenta la advertencia, puede ocasionar daños materiales.

Tabla 1: Niveles de peligrosidad

1.2.2 Símbolos de peligro

Los símbolos de peligro son una representación simbólica que indica el tipo de peligrosidad.

En este documento se utilizan los siguientes símbolos de peligro:

Símbolo de peligro	Significado
	Advertencia general
	Peligro de lesiones por corriente eléctrica
	Riesgo de explosión
	Peligro de lesiones a causa de cortes

i En relación con este documento





Símbolo de peligro	Significado
	Peligro de lesiones por aplastamiento
	Peligro de lesiones por superficies calientes
	Peligro a causa de campos magnéticos de gran potencia
	Peligro derivado de radiación no ionizante

Tabla 2: Símbolos de peligro

1.2.3 Estructura de las advertencias

Las advertencias de este documento tienen una apariencia y una estructura uniformes.

	<div style="background-color: red; color: white; padding: 2px; text-align: center;">⚠ PELIGRO</div> <p>¡Tipo y fuente del peligro! Posibles consecuencias de ignorar el peligro / la advertencia.</p> <ul style="list-style-type: none"> ▶ Medidas y prohibiciones para prevenir el peligro.
--	---

El ejemplo siguiente muestra una advertencia de descarga eléctrica a causa de piezas o partes cargadas con tensión. Se menciona la medida para evitar el peligro.

	<div style="background-color: red; color: white; padding: 2px; text-align: center;">⚠ PELIGRO</div> <p>¡Riesgo de descarga eléctrica debido a partes con tensión! Muerte por electrocución</p> <ul style="list-style-type: none"> ▶ Desconectar el aparato de la red al menos 60 segundos antes de comenzar con la reparación.
--	---

1.2.4 Símbolos generales

En este documento se utilizan los siguientes símbolos generales:

Símbolo general	Significado
	Identificación de una indicación especial (texto y/o gráfico)







Símbolo general	Significado
	Identificación de un consejo simple (solo texto)
	Identificación de un enlace a un video tutorial
	Identificación de una herramienta requerida
	Identificación de una condición previa (prerrequisito)
	Identificación de una condición (si ..., entonces ...)
	Identificación de un resultado
Iniciar	Identificación de una tecla o botón
[00123456]	Identificación de un número de material
Estado	Identificación del texto / ventana mostrado (en el display del aparato)

Tabla 3: Símbolos generales

2.1 Instrucciones generales de seguridad

2.1.1 Todos los aparatos electrodomésticos

¡Riesgo de descarga eléctrica debido a piezas con tensión!

- ¡Los errores en las reparaciones que incluyan componentes eléctricos pueden provocar una descarga eléctrica!
- Desconectar el aparato de la red durante al menos 60 segundos antes de comenzar con el trabajo.
- Después de la reparación, encargar una prueba de seguridad conforme a VDE 0701 o los reglamentos específicos del país.

¡Riesgo de lesiones debido a bordes afilados!

- Usar guantes de protección.

Riesgo de aplastamiento durante la reparación, mantenimiento, resolución de problemas y servicio debido a componentes pesados y móviles

- Usar calzado de seguridad.
- Asegure los componentes pesados para que no se caigan.
- No pegue partes del cuerpo en componentes móviles.





¡Riesgo para la seguridad/el funcionamiento del aparato!





- Utilizar únicamente los repuestos originales.

¡Riesgo de daños de los componentes sensibles a cargas electrostáticas (ESD)!

- No tocar los módulos, incluidas las conexiones y las pistas conductoras.

Herramientas y auxiliares

Designación	Detalles	Imágenes
Herramienta auxiliar [15000155]	Herramienta para aflojar piezas de plástico	
Destornillador Torx T20 con orificio de centrado [00340764]	100 mm, para tornillos de seguridad	
Llave dinamométrica [15000441]	Llave dinamométrica 20 - 100 Nm	
Destornillador plano [00340854]	Punta 3,5 mm x 0,6 mm x 100 mm, Protección aislamiento 1000 V AC	
Destornillador plano [00340855]	Punta 5,5 mm x 1,0 mm x 125 mm, Protección aislamiento 1000 V AC	
Alicates de punta fina curvada [00341269]	Longitud 200 mm	



Designación	Detalles	Imágenes
Alicates corte diagonal [00342182]	Longitud: 200 mm	
Llave combinada [00340811]	Medida llave 10°mm, M6	
Combination wrench [00340814]	Medida llave 13°mm, M8	
Llave combinada [00340817]	Medida llave 17 mm, M10	
Llave combinada [15000459]	Medida llave 16°mm, M10	

4.1 Sustituir la tapa superior

Herramientas necesarias:

-  Punta Torx TX20 con agujero, 6,3 mm (1/4") 152 mm , para tornillos [00341272] larga con pin de seguridad

Requisito:

-  El aparato está desconectado del suministro eléctrico.
-  El aparato está desconectado del suministro de agua.

4.1.1 Desmontar la tapa superior

- ▶ 1. Retirar los tornillos (1).
- ▶ 2. Empujar la tapa superior hacia la parte posterior del aparato (2).
- ▶ 3. Tirar de la tapa superior hacia arriba (3) para retirarla.

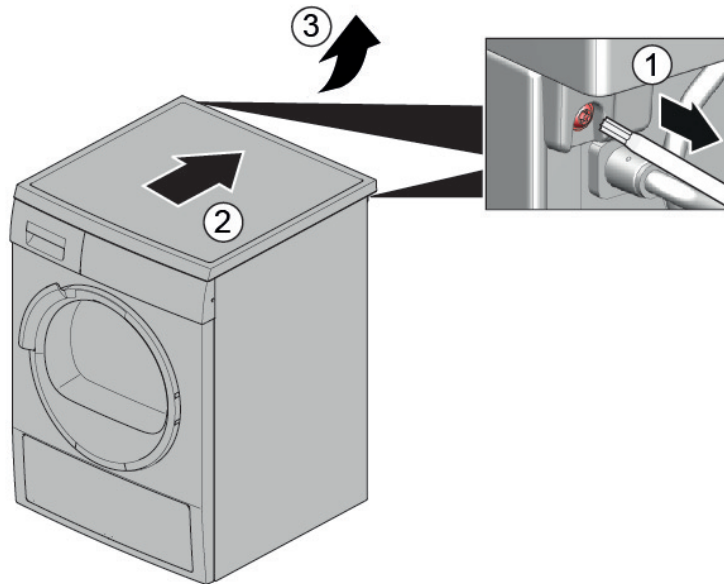



4.1.2 Montar la tapa superior

- ▶ Montar en orden inverso.

4.2 Sustituir el panel de control

	<p>⚠ PRECAUCIÓN</p> <p>¡Bordes de la carcasa cortantes! Peligro de cortes</p> <ul style="list-style-type: none">▶ Usar guantes de seguridad.
--	--

	<p>⚠ ADVERTENCIA</p> <p>¡Deslizamiento de aparatos inclinados! Fracturas óseas / lesiones por aplastamiento</p> <ul style="list-style-type: none">▶ Asegurar los electrodomésticos contra deslizamientos.
--	---

	<p>⚠ PRECAUCIÓN</p> <p>¡Riesgo de que se caigan piezas debido a los tornillos aflojados! Peligro de lesiones debido a piezas que caigan.</p> <ul style="list-style-type: none">▶ Asegure el componente para que no se caiga.
--	--

	<p>⚠ ATENCION</p> <p>¡Riesgo de que se caigan piezas debido a los tornillos aflojados! Daños en otras partes del aparato o en el domicilio del consumidor, p. ej., en la parte inferior.</p> <ul style="list-style-type: none">▶ Asegure el componente para que no se caiga.
--	--

Requisito:

- ✓ El aparato está desconectado del suministro eléctrico.
- ✓ El aparato está desconectado del suministro de agua.
- ✓ [Se ha retirado la tapa superior. → 469](#)
- ✓ [Se ha retirado el compartimento para detergente. → 471](#)

4.2.1 Desmontar el panel de control

1. Retirar los tornillos (1).
2. Desenganchar los elementos de sujeción (2, 3).

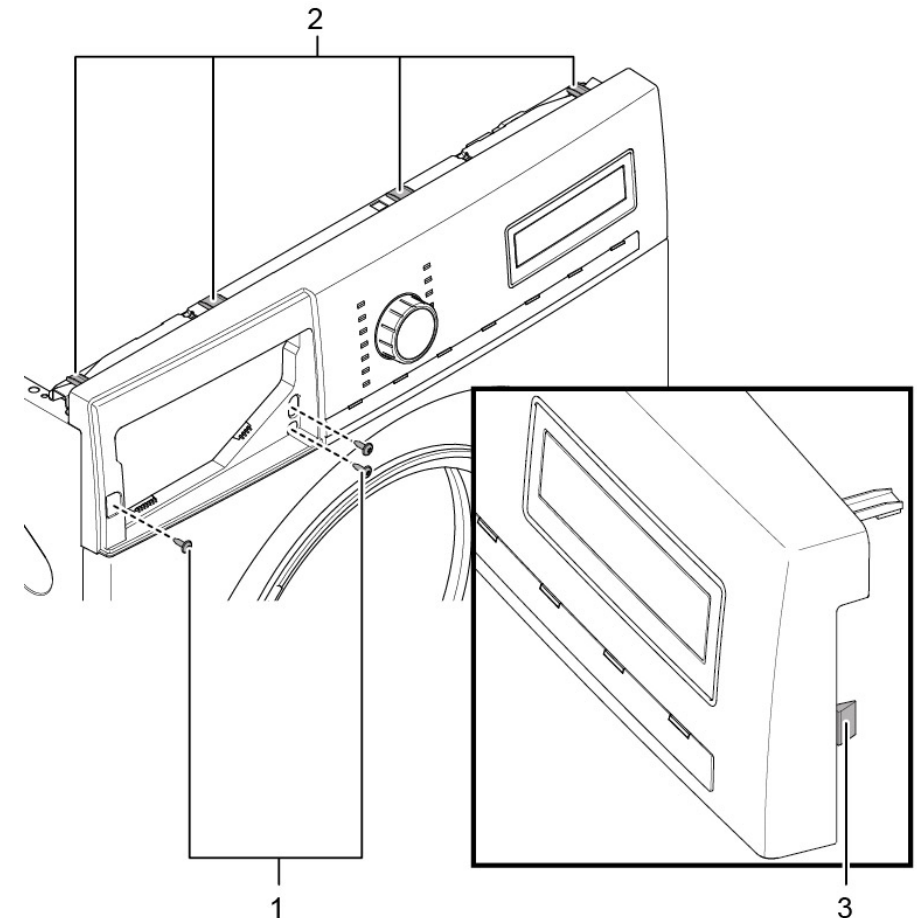

2. Abrir el contacto de enchufe de la unidad de control.
3. Desmontar el panel de control.

4.2.2 Montar el panel de control

- ▶ Montar en orden inverso.

4.3 Sustituir el compartimento para detergente

Requisito:

- ✓ El aparato está desconectado del suministro eléctrico.
- ✓ El aparato está desconectado del suministro de agua.

4.3.1 Desmontar el compartimento para detergente

1. Extraer el compartimento para detergente.
2. 1. Presione hacia abajo en el inserto (1).
2. Desmontar el compartimento para detergente (2).

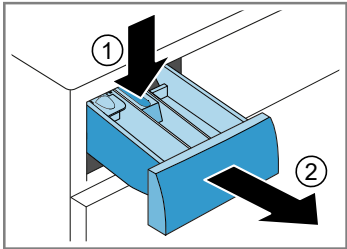

4.3.2 Montar el compartimento para detergente

- ▶ Montar en orden inverso.

4.4 Sustituir el tirador del compartimento para detergente

Requisito:

- ✓ El aparato está desconectado del suministro eléctrico.
- ✓ El aparato está desconectado del suministro de agua.
- ✓ [Se ha retirado el compartimento para detergente.→471](#)

4.4.1 Desmontar el tirador del compartimento para detergente

1. Desenganchar los elementos de sujeción.

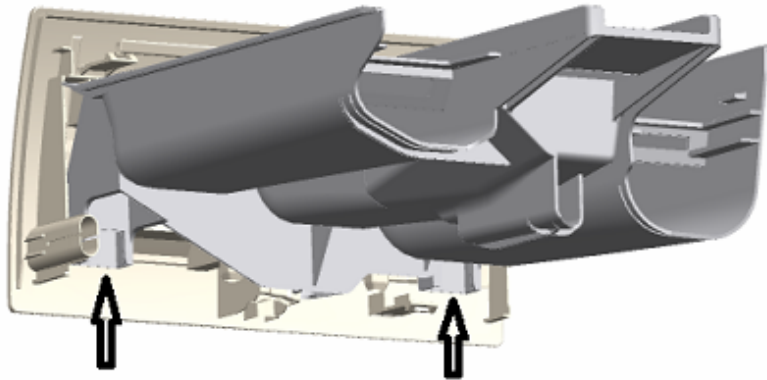

2. Desmontar el tirador del compartimento para detergente.

4.4.2 Montar el tirador del compartimento para detergente

- ▶ Montar en orden inverso.

4.5 Sustituir la puerta



⚠️ PRECAUCIÓN

¡Zona de bisagra abierta!

- Aplastamiento / atrapamiento de dedos
- ▶ No acceder a la zona de la bisagra.
 - ▶ Usar guantes de seguridad.

Requisito:

- ✔ El aparato está desconectado del suministro eléctrico.
- ✔ El aparato está desconectado del suministro de agua.
- ✔ La puerta está abierta.

4.5.1 Extraer la puerta

1.



⚠️ ATENCION

¡Riesgo de que se caigan piezas debido a los tornillos aflojados!

Daños en otras partes del aparato o en el domicilio del consumidor, p. ej., en la parte inferior.

- ▶ Asegure el componente para que no se caiga.



⚠️ PRECAUCIÓN

¡Riesgo de que se caigan piezas debido a los tornillos aflojados!

Peligro de lesiones debido a piezas que caigan.

- ▶ Asegure el componente para que no se caiga.

Retirar los tornillos (1).

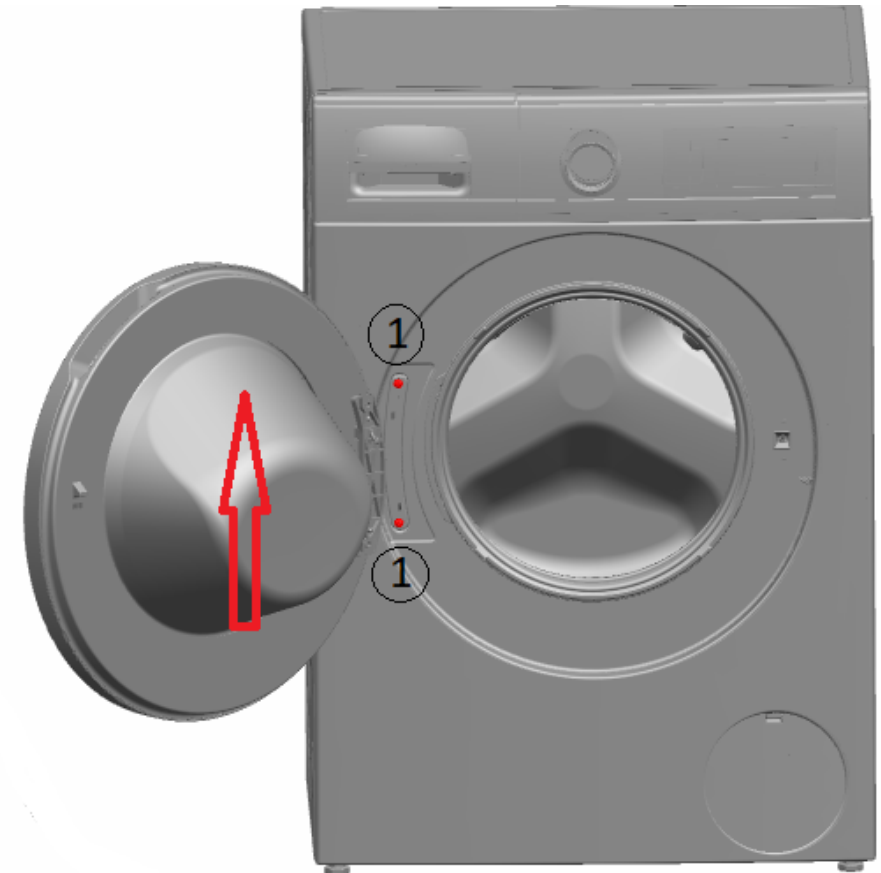

2. Extraer la puerta hacia arriba.

4.5.2 Montar la puerta

- ▶ Montar en orden inverso.

4.6 Sustituir los componentes de la puerta



PRECAUCIÓN

¡Zona de bisagra abierta!

Aplastamiento / atrapamiento de dedos

- ▶ No acceder a la zona de la bisagra.
- ▶ Usar guantes de seguridad.

Requisito:

- ✓ El aparato está desconectado del suministro eléctrico.
- ✓ El aparato está desconectado del suministro de agua.
- ✓ [Se ha retirado la puerta.→473](#)

4.6.1 Desmontar los componentes de la puerta

- ▶ Desmontar la puerta desde fuera hacia dentro.

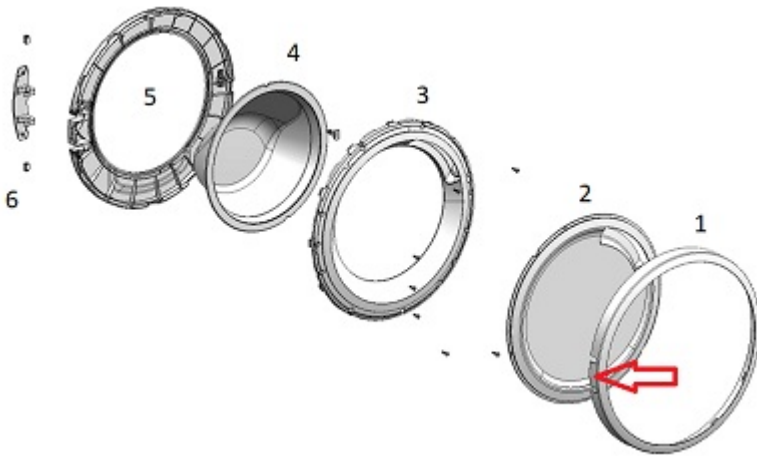

4.6.2 Montar los componentes de la puerta

- ▶ Montar en orden inverso.

4.7 Sustituir la junta de la puerta



⚠️ PRECAUCIÓN

¡Bordes de la carcasa cortantes!
Peligro de cortes
▶ Usar guantes de seguridad.



⚠️ PRECAUCIÓN

¡Riesgo de que se caigan piezas debido a los tornillos aflojados!
Peligro de lesiones debido a piezas que caigan.
▶ Asegure el componente para que no se caiga.



⚠️ ATENCION

¡Riesgo de que se caigan piezas debido a los tornillos aflojados!
Daños en otras partes del aparato o en el domicilio del consumidor,
p. ej., en la parte inferior.
▶ Asegure el componente para que no se caiga.

Requisito:

- ✓ El aparato está desconectado del suministro eléctrico.
- ✓ El aparato está desconectado del suministro de agua.
- ✓ [Se ha retirado el compartimento para detergente. →471](#)
- ✓ [Se ha retirado la puerta. →473](#)
- ✓ [Se ha retirado la tapa de la bomba. →482](#)

4.7.1 Extraer la junta de la puerta

1.



⚠️ ADVERTENCIA

¡Deslizamiento de aparatos inclinados!
Fracturas óseas / lesiones por aplastamiento
▶ Asegurar los electrodomésticos contra deslizamientos.

Levantar el aparato por delante.

2. Aflojar los tornillos en la parte inferior del panel frontal (1).

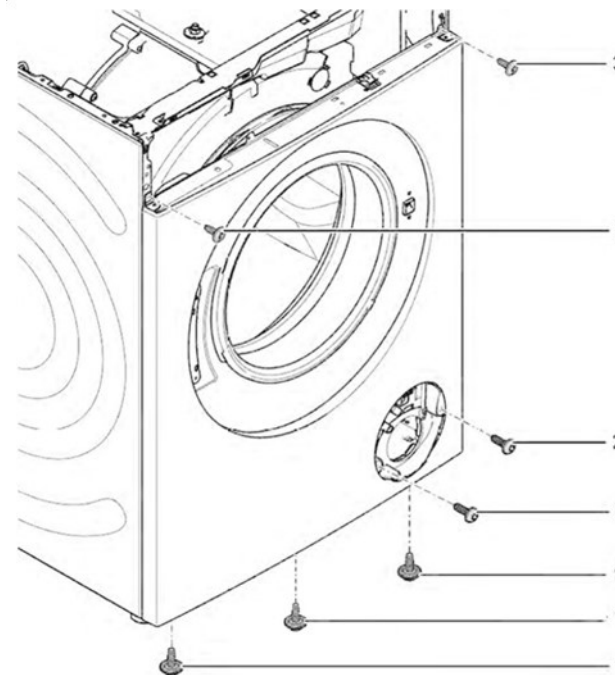

3. Bajar el aparato.

Reparación

4. Retirar los tornillos en la zona de la bomba (2).

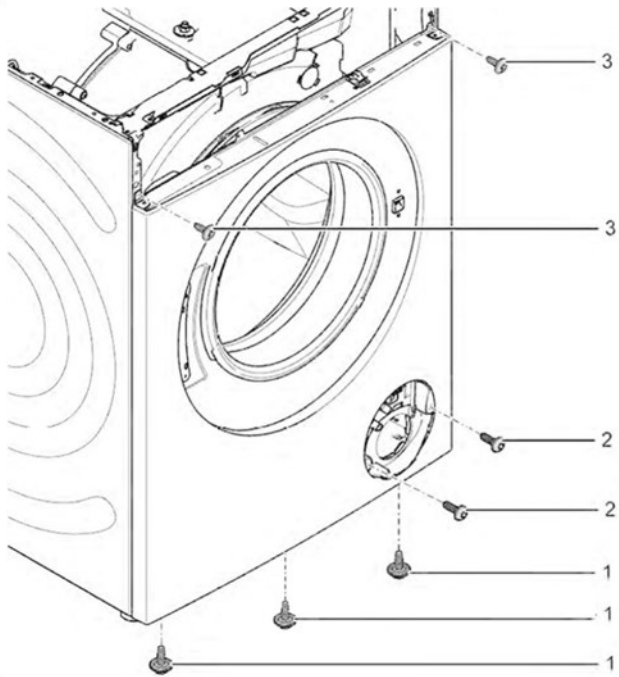

5. 1. Aflojar los tornillos en la parte posterior del aparato (1).
2. Quitar la tapa superior (2, 3).

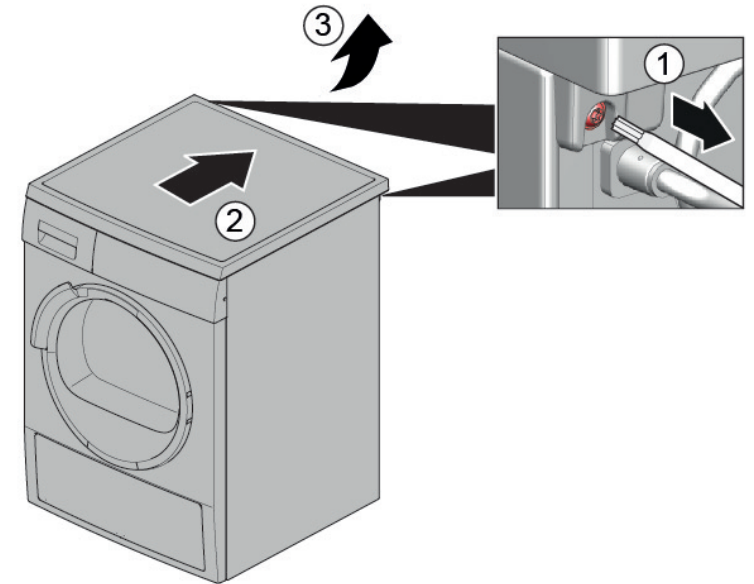

Reparación

6. 1. Retirar los tornillos (1).
2. Desenganchar los elementos de sujeción del panel de control (2, 3).
3. Aflojar los tornillos de la carcasa del compartimento.

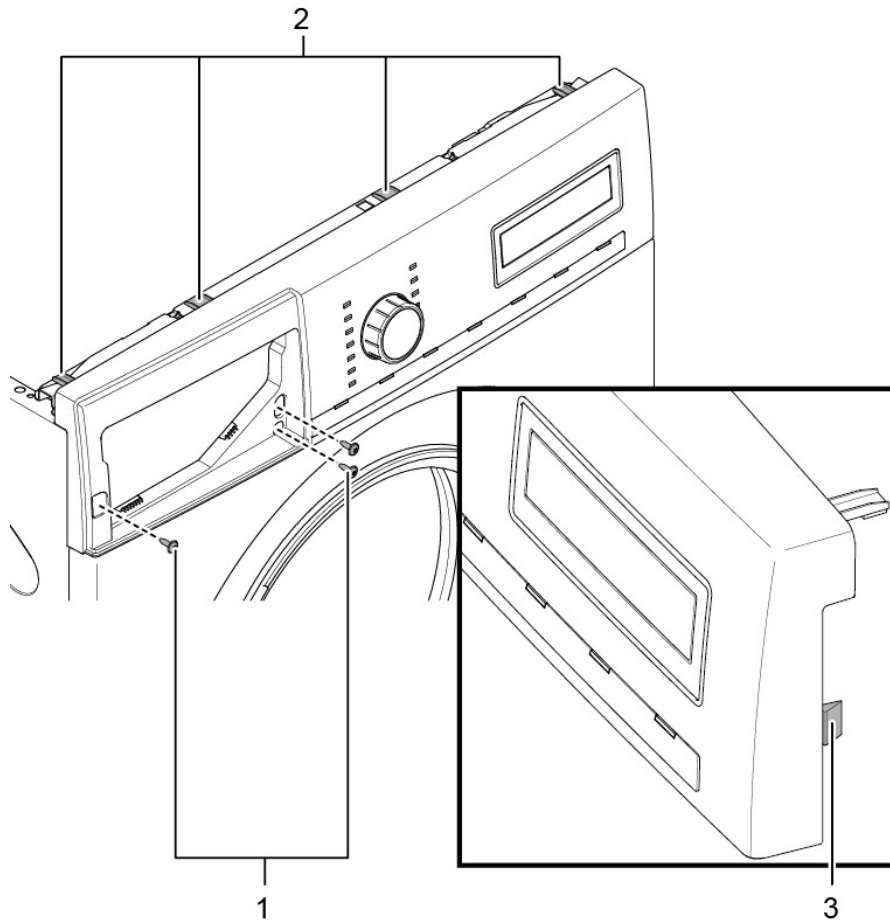

7. Desmontar el panel de control.

8. Desmontar el soporte de la iluminación del tambor en la parte superior.

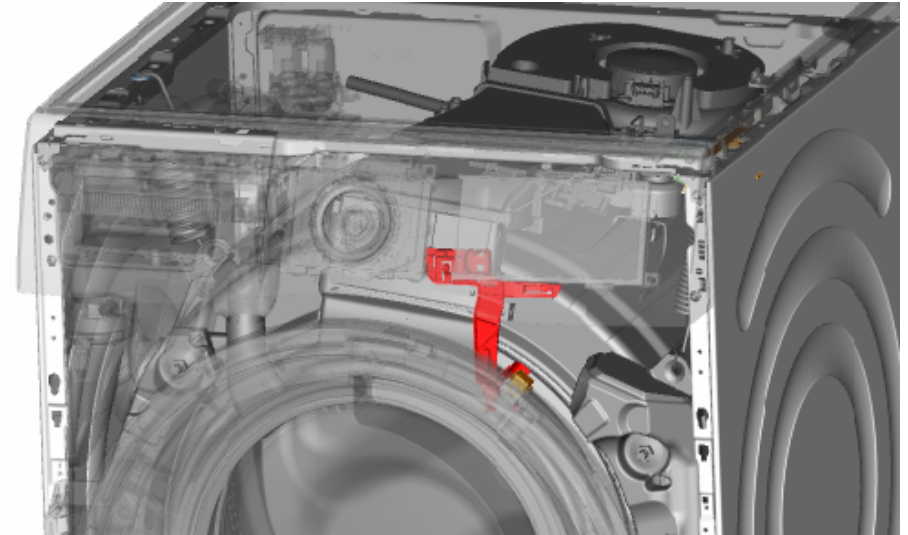

- 9.



ATENCIÓN

¡Riesgo de daños en la superficie!

La superficie del aparato puede sufrir arañazos si se utilizan las herramientas incorrectas.

- ▶ Utilizar únicamente herramientas de plástico para sustituir el anillo de fijación.

Desmontar el anillo de fijación de la junta con una herramienta de plástico.

10. Quitar la junta de la puerta del panel frontal.
11. Abrir el conector de cable del cierre de la puerta.

12. Aflojar los tornillos de la parte superior del panel frontal (3).

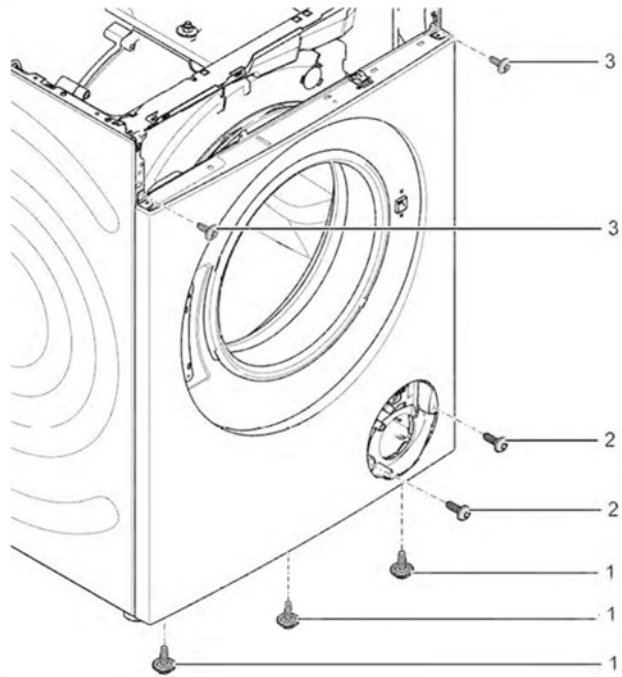

13. Retirar el panel frontal.

14. Aflojar todas las conexiones de manguera.

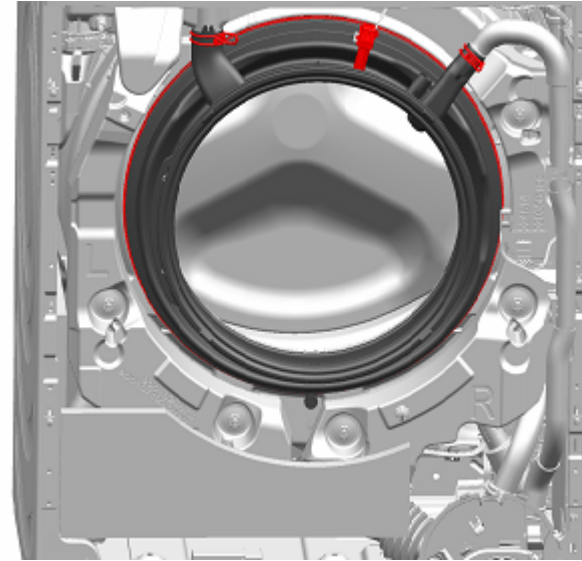

15. Retirar la junta de la puerta.

4.7.2 Montar la junta de la puerta



ADVERTENCIA

¡Riesgo de que se caigan piezas debido a una instalación incorrecta!

Lesiones o daños en el aparato.

- ▶ Apretar el anillo de tensión de la junta de la puerta con 3,4 Nm.

- ▶ Montar en orden inverso.

4.8 Sustituir el cierre de la puerta

Como fabricante, estamos obligados a proporcionar a los clientes la pieza de repuesto de la cerradura de puerta, incluidas las instrucciones de reparación conforme al Reglamento (UE) 2019/2023. No obstante, nos gustaría resaltar que después de reemplazar la cerradura de la puerta, es necesario que un electricista cualificado realice una prueba de seguridad electrotécnica antes de poner el aparato en funcionamiento. Esta persona debe estar cualificada (de forma verificable) de acuerdo con las leyes, reglamentos y normas específicos del país.

	⚠ PELIGRO
	¡Riesgo de descarga eléctrica debido a piezas con tensión! Peligro mortal por descarga eléctrica en caso de reparación inadecuada <ul style="list-style-type: none">▶ Las piezas eléctricas deberían ser reparadas por electricistas cualificados.▶ Después de la reparación, encargar una prueba de seguridad conforme a VDE 0701 o los reglamentos específicos del país.

	⚠ PRECAUCIÓN
	¡Bordes de la carcasa cortantes! Peligro de cortes <ul style="list-style-type: none">▶ Usar guantes de seguridad.

	⚠ ADVERTENCIA
	¡Deslizamiento de aparatos inclinados! Fracturas óseas / lesiones por aplastamiento <ul style="list-style-type: none">▶ Asegurar los electrodomésticos contra deslizamientos.

	⚠ PRECAUCIÓN
	¡Riesgo de que se caigan piezas debido a los tornillos aflojados! Peligro de lesiones debido a piezas que caigan. <ul style="list-style-type: none">▶ Asegure el componente para que no se caiga.

	⚠ ATENCION
	¡Riesgo de que se caigan piezas debido a los tornillos aflojados! Daños en otras partes del aparato o en el domicilio del consumidor, p. ej., en la parte inferior. <ul style="list-style-type: none">▶ Asegure el componente para que no se caiga.

Requisito:

- ✓ El aparato está desconectado del suministro eléctrico.
- ✓ El aparato está desconectado del suministro de agua.
- ✓ Puede accederse libremente al aparato.
- ✓ [Se ha retirado la tapa superior.→469](#)
- ✓ Se ha retirado el panel de control.
- ✓ [Se ha retirado la puerta.→473](#)
- ✓ Se ha retirado el anillo de fijación.
- ✓ Se ha retirado el panel frontal.
- ✓ Se ha retirado la junta de la puerta.

4.8.1 Extraer el cierre de la puerta

1. Desconectar el enchufe del cierre de la puerta.
2. Abrir el cierre de la puerta.



3. Retirar el cierre de la puerta.

4.8.2 Montar el cierre de la puerta

El cierre de la puerta debe estar en la posición correcta para garantizar la función del aparato para apertura de emergencia de la puerta.

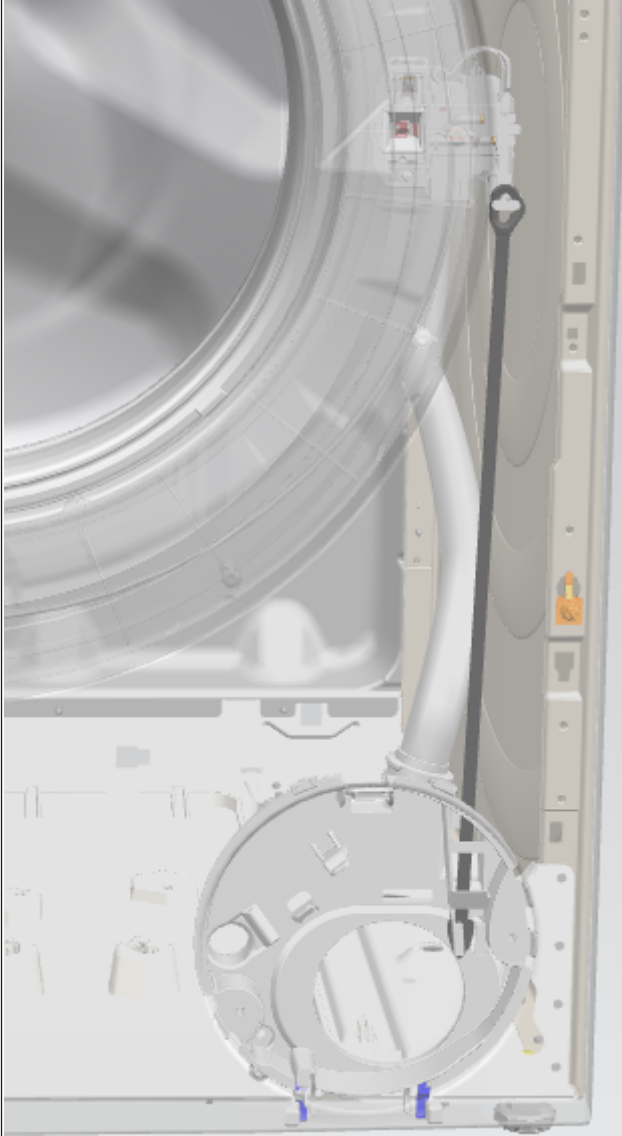



- ▶ Montar en orden inverso.

4.9 Sustituir la iluminación del tambor

	⚠ PRECAUCIÓN ¡Bordes de la carcasa cortantes! Peligro de cortes ▶ Usar guantes de seguridad.
--	---

	⚠ ADVERTENCIA ¡Deslizamiento de aparatos inclinados! Fracturas óseas / lesiones por aplastamiento ▶ Asegurar los electrodomésticos contra deslizamientos.
--	--

	⚠ PRECAUCIÓN ¡Riesgo de que se caigan piezas debido a los tornillos aflojados! Peligro de lesiones debido a piezas que caigan. ▶ Asegure el componente para que no se caiga.
--	---

	⚠ ATENCION ¡Riesgo de que se caigan piezas debido a los tornillos aflojados! Daños en otras partes del aparato o en el domicilio del consumidor, p. ej., en la parte inferior. ▶ Asegure el componente para que no se caiga.
--	---

Requisito:

- ✔ El aparato está desconectado del suministro eléctrico.
- ✔ El aparato está desconectado del suministro de agua.
- ✔ Puede accederse libremente al aparato.
- ✔ [Se ha retirado la tapa superior.→469](#)
- ✔ [Se ha retirado el compartimento para detergente.→471](#)
- ✔ Se ha retirado el panel de control.

4.9.1 Desmontar la iluminación del tambor

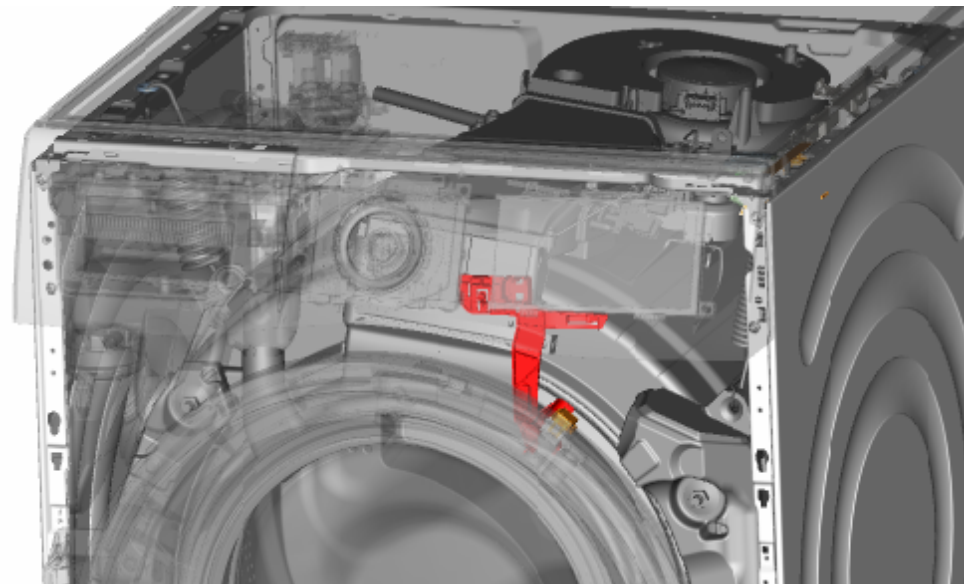

1. Sacar del aparato el soporte de la iluminación del tambor.
2. Desconectar las conexiones eléctricas.
3. Desmontar la iluminación del tambor del soporte.

4.9.2 Montar la iluminación del tambor

- ▶ Montar en orden inverso.

4.10 Sustituir la tapa de la bomba

Requisito:

- ✓ El aparato está desconectado del suministro eléctrico.
- ✓ El aparato está desconectado del suministro de agua.

4.10.1 Retirar la tapa de la bomba

1. Abrir la tapa de la bomba.

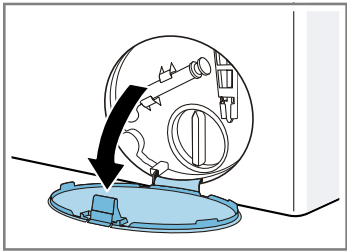

2. Retirar la tapa de la bomba.

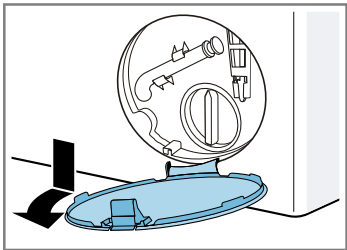

4.10.2 Montar la tapa de la bomba

- ▶ Montar en orden inverso.

4.11 Sustituir el panel frontal



⚠️ PRECAUCIÓN

¡Bordes de la carcasa cortantes!
Peligro de cortes
▶ Usar guantes de seguridad.

Requisito:

- ✓ El aparato está desconectado del suministro eléctrico.
- ✓ El aparato está desconectado del suministro de agua.
- ✓ [Se ha retirado el compartimento para detergente. →471](#)
- ✓ [Se ha retirado la puerta. →473](#)
- ✓ Se ha retirado la junta de la puerta.
- ✓ [Se ha retirado la tapa de la bomba. →482](#)

4.11.1 Extraer el panel frontal

1.



⚠️ ADVERTENCIA

¡Deslizamiento de aparatos inclinados!
Fracturas óseas / lesiones por aplastamiento
▶ Asegurar los electrodomésticos contra deslizamientos.

Levantar el aparato por delante.

2. Aflojar los tornillos de la parte inferior (1).

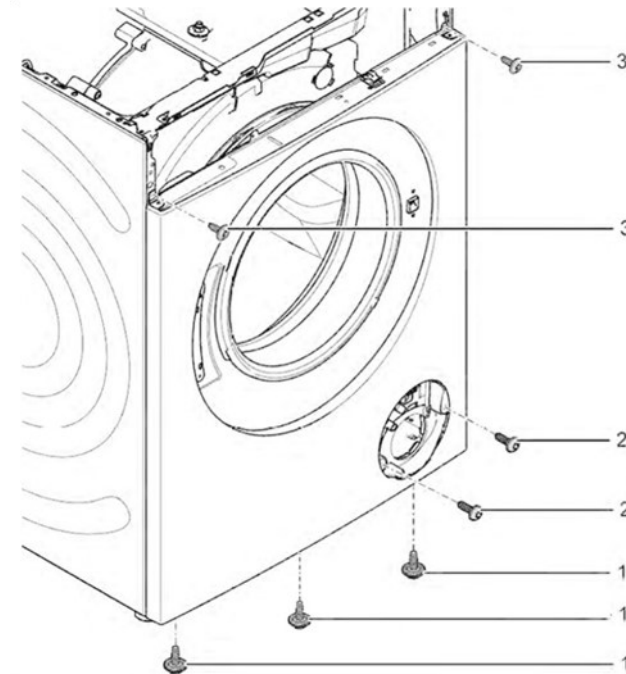

3. Bajar el aparato.

Reparación

4. 1. Retirar los tornillos (1).
2. Empujar la tapa superior hacia la parte posterior del aparato (2).
3. Tirar de la tapa superior hacia arriba (3) para retirarla.

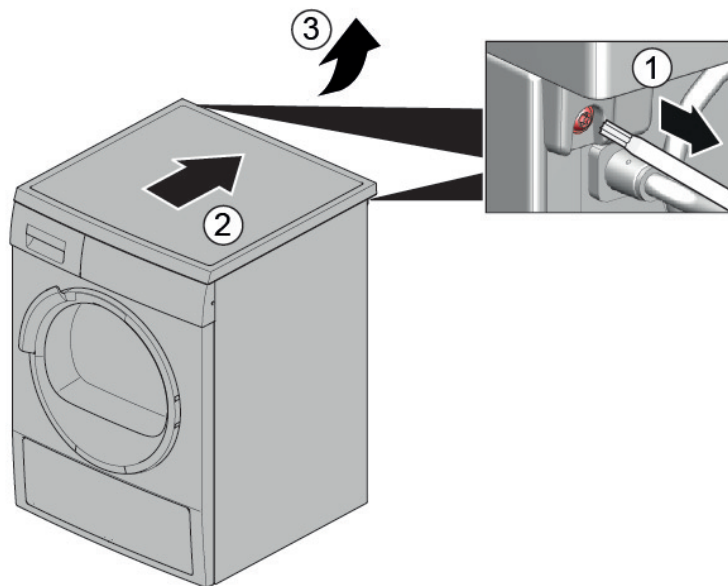

5. 1. Retirar los tornillos (1).
2. Desenganchar los elementos de sujeción (2, 3).

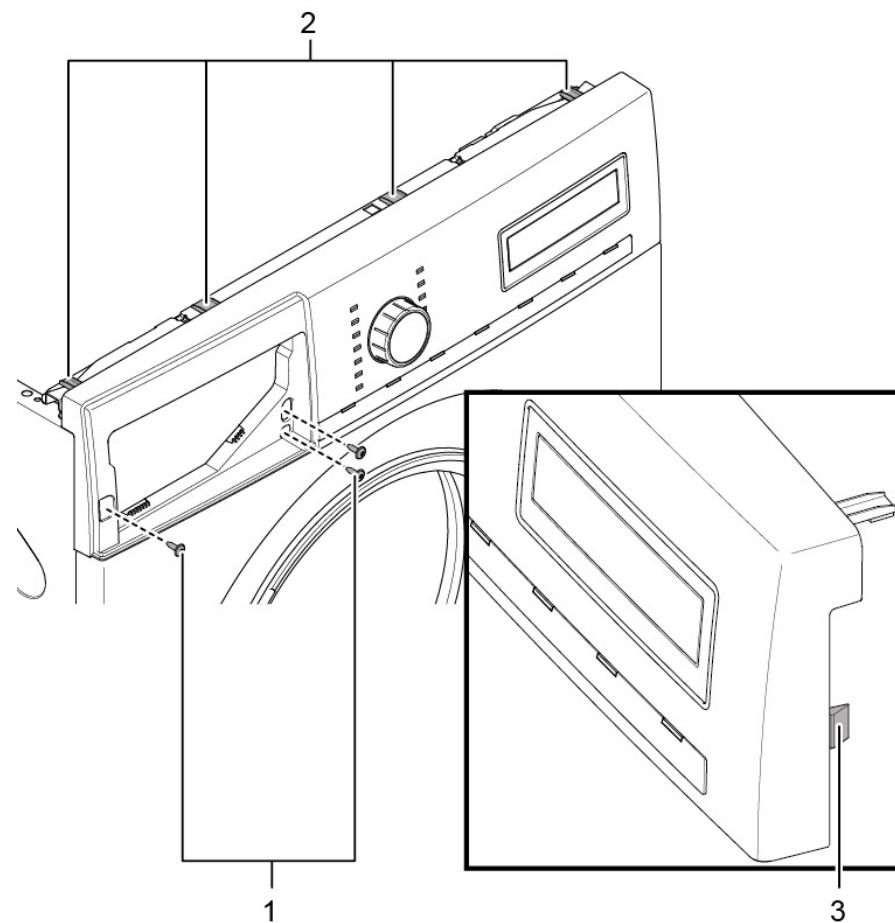

6. Desmontar el panel de control.

7.



PRECAUCIÓN

¡Riesgo de que se caigan piezas debido a los tornillos aflojados!
Peligro de lesiones debido a piezas que caigan.
▶ Asegure el componente para que no se caiga.



ATENCIÓN

¡Riesgo de que se caigan piezas debido a los tornillos aflojados!
Daños en otras partes del aparato o en el domicilio del consumidor, p. ej., en la parte inferior.
▶ Asegure el componente para que no se caiga.

Retirar los tornillos de la parte frontal empezando por la parte inferior hasta la superior (2, 3).

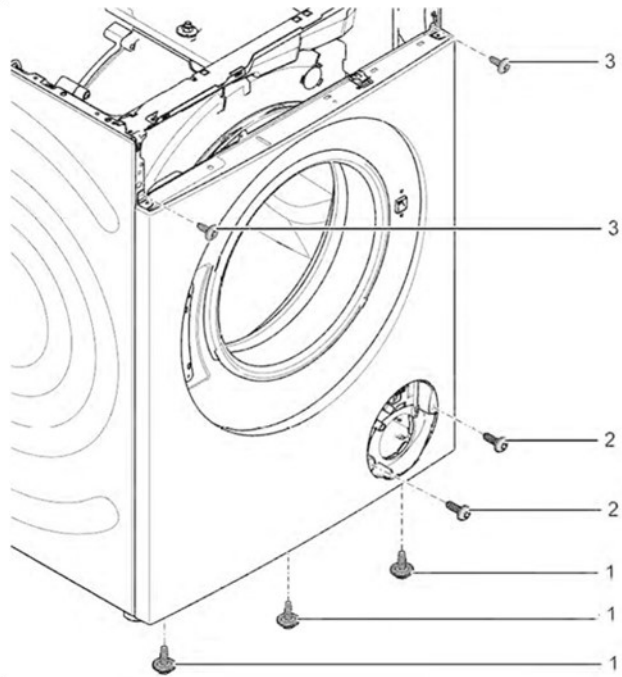

8. Retirar el panel frontal.

4.11.2 Montar el panel frontal

▶ Montar en orden inverso.

Reparationsinformation - Tvättmaskin

Om detta dokument..... 487

1.1	Viktig information.....	487
1.1.1	Syfte.....	487
1.2	Symbolförklaringar.....	487
1.2.1	Faronivåer.....	487
1.2.2	Risksymboler.....	487
1.2.3	Varningarnas struktur.....	488
1.2.4	Allmänna symboler.....	488

Säkerhet..... 489

2.1	Allmänna säkerhetsanvisningar.....	489
2.1.1	Alla hushållsmaskiner.....	489

Verktyg och hjälpmedel..... 490

Reparation..... 491

4.1	Byta arbetsbänk.....	491
4.1.1	Ta bort arbetsbänk.....	491
4.1.2	Montera arbetsbänk.....	491
4.2	Byta kontrollpanel.....	492
4.2.1	Ta bort kontrollpanel.....	492
4.2.2	Montera kontrollpanel.....	492
4.3	Byta tvättmedelsfack.....	493
4.3.1	Ta bort tvättmedelsfack.....	493
4.3.2	Montera tvättmedelsfack.....	493
4.4	Byta handtag till tvättmedelsfack.....	494
4.4.1	Ta bort handtag till tvättmedelsfack.....	494
4.4.2	Montera handtag till tvättmedelsfack.....	494
4.5	Byta lucka.....	495
4.5.1	Ta bort lucka.....	495
4.5.2	Montera lucka.....	495
4.6	Byta luckans komponenter.....	496
4.6.1	Ta bort luckans komponenter.....	496
4.6.2	Montera luckans komponenter.....	496
4.7	Byta luckans tätning.....	497
4.7.1	Ta bort luckans tätning.....	497
4.7.2	Montera luckans tätning.....	500

4.8	Byta luckans lås.....	501
4.8.1	Ta bort luckans lås.....	501
4.8.2	Montera luckans lås.....	502
4.9	Byta trummans lampa.....	503
4.9.1	Ta bort trummans lampa.....	503
4.9.2	Montera luckans lampa.....	503
4.10	Byta pumphölje.....	504
4.10.1	Ta bort pumphölje.....	504
4.10.2	Montera pumphölje.....	504
4.11	Byta frontpanel.....	505
4.11.1	Ta bort frontpanel.....	505
4.11.2	Montera frontpanel.....	507

i Om detta dokument

1.1 Viktig information

1.1.1 Syfte

Dessa reparationstips hjälper kunden att själv reparera maskiner enligt gällande ekodesignbestämmelser (som gäller 03/2021).





De innehåller information om hur vissa reservdelar ska bytas samt tillhörande varningar och risker.

Kontakta vår kundtjänst om du har frågor. Vi åtar oss bara ansvar för skador om reparationstipsen har följts korrekt.

1.2 Symbolförklaringar

1.2.1 Faronivåer

Varningsnivåerna består av en symbol och ett signalord. Signalordet visar hur allvarlig faran är.





Varningsnivå	Innebörd
	Om inte varningsmeddelandet följs kommer det att leda till dödsfall eller allvarliga personskador.
	Om inte varningsmeddelandet följs kan det leda till dödsfall eller allvarliga personskador.
	Om inte varningsmeddelandet följs kan det leda till lättare personskador.
	Om inte varningsmeddelandet följs kan det leda till materialskador.

Grafik 1: Faronivåer



1.2.2 Risksymboler

Risksymboler är symboler som visar typen av fara.

Följande risksymboler används i detta dokument:

Risksymbol	Innebörd
	Allmänt varningsmeddelande
	Fara på grund av elektrisk spänning
	Explosionsrisk
	Fara för skärskador
	Fara för krosskador



i Om detta dokument

Risksymbol	Innebörd
	Fara på grund av heta ytor
	Fara på grund av starka magnetfält
	Fara på grund av icke-joniserande strålning

Grafik 2: Risksymboler

1.2.3 Varningarnas struktur

Varningar i detta dokument har ett standardiserat utseende och en standardiserad struktur.



	<p> FARA!</p> <p>Farans typ och ursprung! Möjliga konsekvenser av att faran/varningen ignoreras.</p> <ul style="list-style-type: none"> ▶ Åtgärder och förbud för att förebygga faran.
--	--





Följande exempel visar en varning som varnar för elstötar från strömförande delar. Det står vilken åtgärd som förebygger faran.

	<p> FARA!</p> <p>Risk för elstötar på grund av strömförande delar! Dödsfall på grund av elstötar</p> <ul style="list-style-type: none"> ▶ Koppla bort maskiner från elförsörjningen minst 60 sekunder innan reparationer påbörjas.
---	---

1.2.4 Allmänna symboler

Följande allmänna symboler används i detta dokument:

Allm. symbol	Innebörd
	Identifiering av ett särskilt tips (text och/eller bild)
	Identifiering av ett enkelt tips (endast text)

Allm. symbol	Innebörd
	Identifiering av en länk till en videohandledning
	Identifiering av verktyg som behövs
	Identifiering av villkor som måste vara uppfyllda
	Identifiering av ett tillstånd (om ..., så ...)
	Identifiering av ett resultat
[Start]	Identifiering av en tangent eller knapp
[00123456]	Identifiering av ett materialnummer
Status	Identifiering av text/fönster som visas (i maskinens display)

Grafik 3: Allmänna symboler

2.1 Allmänna säkerhetsanvisningar

2.1.1 Alla hushållsmaskiner

Risk för elstötar på grund av strömförande delar!

- Fel vid reparationer som berör elkomponenter kan orsaka elstötar!
- Koppla bort maskinen från elnätet minst 60 sekunder innan arbetet påbörjas.
- Låt utföra ett säkerhetstest efter reparationen, i enlighet med VDE 0701 eller landsspecifika regler.

Risk för personskador på grund av vassa kanter!

- Använd skyddshandskar.

Risk för krosskador vid reparation, underhåll, felsökning och service på grund av tunga och rörliga komponenter

- Använd skyddsskor.
- Säkra tunga komponenter så att de inte faller ner.
- Stick inte in kroppsdelar i rörliga komponenter.







Risk för maskinens säkerhet/funktion!





- Använd endast originaldelar.

Risk för skador på komponenter känsliga för statisk elektricitet (ESD)!

- Rör inte modulerna samt anslutningar och strömförande ledningar.

Verktyg och hjälpmedel

Beteckning	Detaljer	Bilder
Hjälpverktyg [15000155]	Verktyg för att lossa plastdelar	
Skruvmejsel torx T20 med borrhål [00340764]	100 mm, för skruvar med säkerhetsstift	
Momentnyckel [15000441]	Momentnyckel 20 - 100 Nm	
Spårskruvmejsel [00340854]	Blad 3,5 mm x 0,6 mm x 100 mm, skyddsisolering 1000 V AC	
Spårskruvmejsel [00340855]	Blad 5,5 mm x 1,0 mm x 125 mm, skyddsisolering 1000 V AC	
Spetstång, böjd [00341269]	Längd 200 mm	
Sidavbitare [00342182]	Längd: 200 mm	



Beteckning	Detaljer	Bilder
Kombinationsnyckel [00340811]	Skiftnyckelstorlek 10 ^o mm, M6	
Combination w- rench [00340814]	Skiftnyckelstorlek 13 ^o mm, M8	
Kombinationsnyckel [00340817]	Skiftnyckelstorlek 17 mm, M10	
Kombinationsnyckel [15000459]	Skiftnyckelstorlek 16 ^o mm, M10	

4.1 Byta arbetsbänk

Nödvändiga verktyg:

-  Torxbits TX20 med hål, lång 6,3°mm (1/4") 152°mm, för skruvar [00341272] med säkerhetsstift

Förutsättning:

-  Apparaten är bortkopplad från strömförsörjning.
-  Apparaten är bortkopplad från vattenförsörjning.

4.1.1 Ta bort arbetsbänk

- ▶ 1. Ta bort skruvarna (1).
- ▶ 2. Tryck arbetsbänken mot maskinens baksida (2).
- ▶ 3. Flytta arbetsbänken uppåt (3) för att ta bort den.

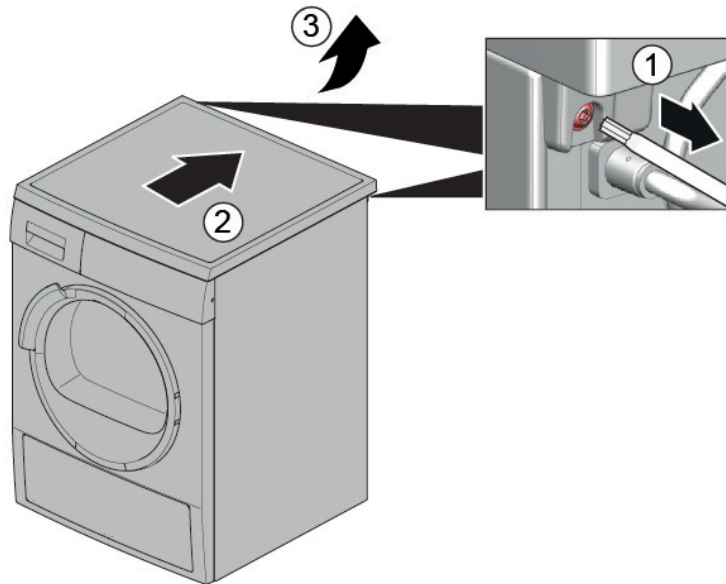

4.1.2 Montera arbetsbänk

- ▶ Montera i omvänd ordning.

4.2 Byta kontrollpanel



FÖRSIKTIGT!

Vassa höljeskanter!
Skärskador
▶ Använd skyddshandskar.



VARNING!

Lutande maskiner kan glida!
Frakturer/krosskador
▶ Säkra maskiner så att de inte kan glida.



FÖRSIKTIGT!

Risk för fallande delar på grund av lossade skruvar!
Personskador på grund av fallande delar.
▶ Säkra komponenter så att de inte faller ner.



OBS!

Risk för fallande delar på grund av lossade skruvar!
Materiella skador på andra delar av maskinen eller i kundens hem, t.ex. vid botten.
▶ Säkra komponenter så att de inte faller ner.

Förutsättning:

- ✓ Apparaten är bortkopplad från strömförsörjning.
- ✓ Apparaten är bortkopplad från vattenförsörjning.
- ✓ [Arbetsbänken har tagits bort.→491](#)
- ✓ [Tvättmedelsfacket har tagits bort.→493](#)

4.2.1 Ta bort kontrollpanel

1. Ta bort skruvarna (1).
2. Lossa fästelementen (2, 3).

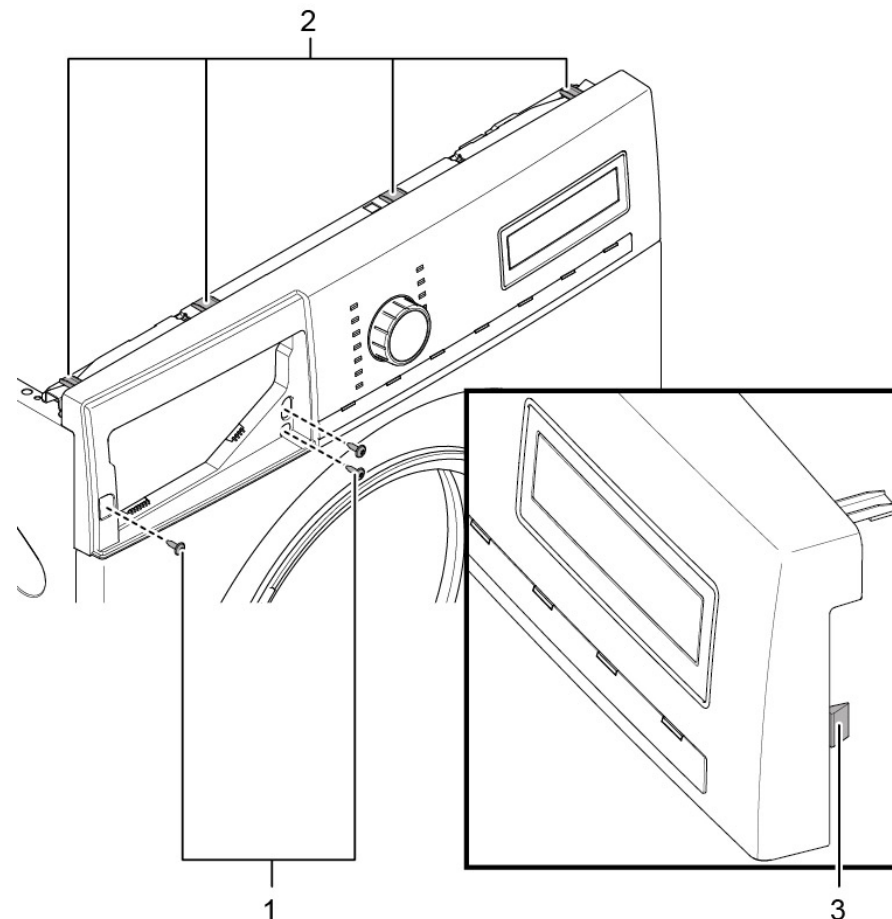

2. Lossa stickkontakten till styrenheten.
3. Ta bort kontrollpanelen.

4.2.2 Montera kontrollpanel

- ▶ Montera i omvänd ordning.

4.3 Byta tvättmedelsfack

Förutsättning:

- ✓ Apparatens är bortkopplad från strömförsörjning.
- ✓ Apparatens är bortkopplad från vattenförsörjning.

4.3.1 Ta bort tvättmedelsfack

1. Dra ut tvättmedelsfacket.
2. 1. Tryck nedåt på insatsen (1).
2. Ta ut tvättmedelsfacket (2).

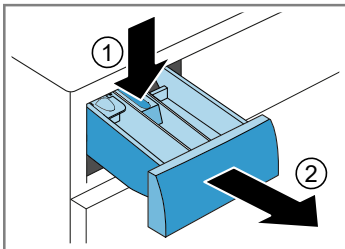

4.3.2 Montera tvättmedelsfack

- ▶ Montera i omvänd ordning.

4.4 Byta handtag till tvättmedelsfack

Förutsättning:

- ✓ Apparaten är bortkopplad från strömförsörjning.
- ✓ Apparaten är bortkopplad från vattenförsörjning.
- ✓ [Tvättmedelsfacket har tagits bort.](#)→493

4.4.1 Ta bort handtag till tvättmedelsfack

1. Lossa fästelementen.

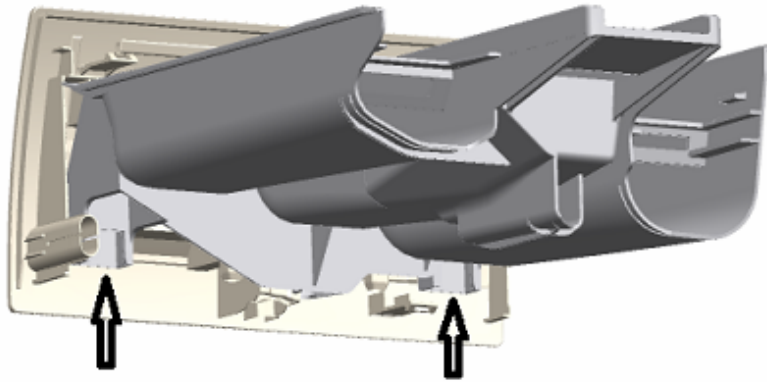

2. Ta bort handtaget till tvättmedelsfacket.

4.4.2 Montera handtag till tvättmedelsfack

- ▶ Montera i omvänd ordning.

4.5 Byta lucka



⚠️ FÖRSIKTIGT!

Öppna gångjärnsdelen!

Risk för att fingrar krossas/fastnar

- ▶ Stick inte in händerna i gångjärnsdelen.
- ▶ Använd skyddshandskar.

Förutsättning:

- ✔ Apparaten är bortkopplad från strömförsörjning.
- ✔ Apparaten är bortkopplad från vattenförsörjning.
- ✔ Luckan är öppen.

4.5.1 Ta bort lucka

1.



OBS!

Risk för fallande delar på grund av lossade skruvar!

Materiella skador på andra delar av maskinen eller i kundens hem, t.ex. vid botten.

- ▶ Säkra komponenter så att de inte faller ner.



⚠️ FÖRSIKTIGT!

Risk för fallande delar på grund av lossade skruvar!

Personskador på grund av fallande delar.

- ▶ Säkra komponenter så att de inte faller ner.

Ta bort skruvarna (1).

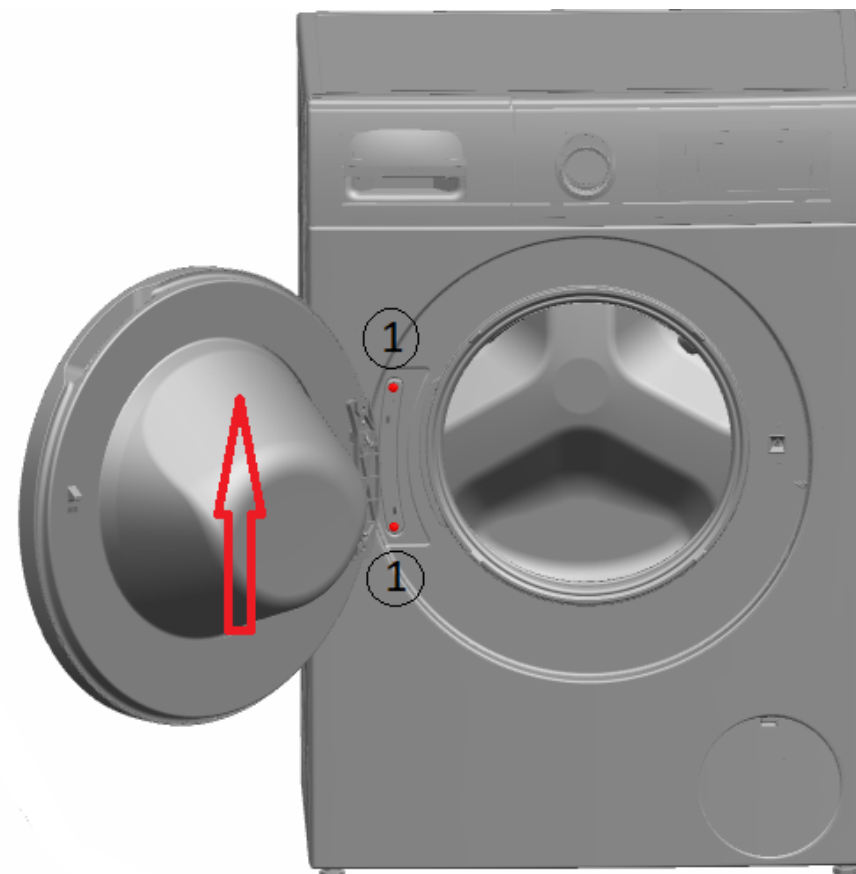

2. Flytta luckan uppåt.

4.5.2 Montera lucka

- ▶ Montera i omvänd ordning.

4.6 Byta luckans komponenter



FÖRSIKTIGT!

Öppna gångjärnsdelen!

Risk för att fingrar krossas/fastnar

- ▶ Stick inte in händerna i gångjärnsdelen.
- ▶ Använd skyddshandskar.

Förutsättning:

- ✓ Apparatens är bortkopplad från strömförsörjning.
- ✓ Apparatens är bortkopplad från vattenförsörjning.
- ✓ [Luckan har tagits bort. → 495](#)

4.6.1 Ta bort luckans komponenter

- ▶ Demontera luckan utifrån och in.

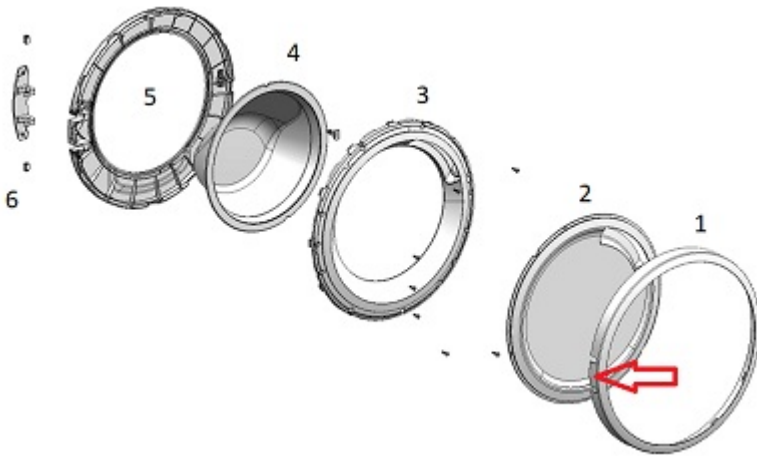

4.6.2 Montera luckans komponenter

- ▶ Montera i omvänd ordning.

4.7 Byta luckans tätning



FÖRSIKTIGT!

Vassa höljeskanter!
Skärskador
▶ Använd skyddshandskar.



FÖRSIKTIGT!

Risk för fallande delar på grund av lossade skruvar!
Personskador på grund av fallande delar.
▶ Säkra komponenter så att de inte faller ner.



OBS!

Risk för fallande delar på grund av lossade skruvar!
Materiella skador på andra delar av maskinen eller i kundens hem, t.ex. vid botten.
▶ Säkra komponenter så att de inte faller ner.

Förutsättning:

- ✓ Apparaten är bortkopplad från strömförsörjning.
- ✓ Apparaten är bortkopplad från vattenförsörjning.
- ✓ [Tvättmedelsfacket har tagits bort.→493](#)
- ✓ [Luckan har tagits bort.→495](#)
- ✓ [Pumphöljet har tagits bort.→504](#)

4.7.1 Ta bort luckans tätning

1.



VARNING!

Lutande maskiner kan glida!
Frakturer/krosskador
▶ Säkra maskiner så att de inte kan glida.

Lyft upp maskinen framtill.

2. Lossa skruvarna längst ner på frontpanelen (1).

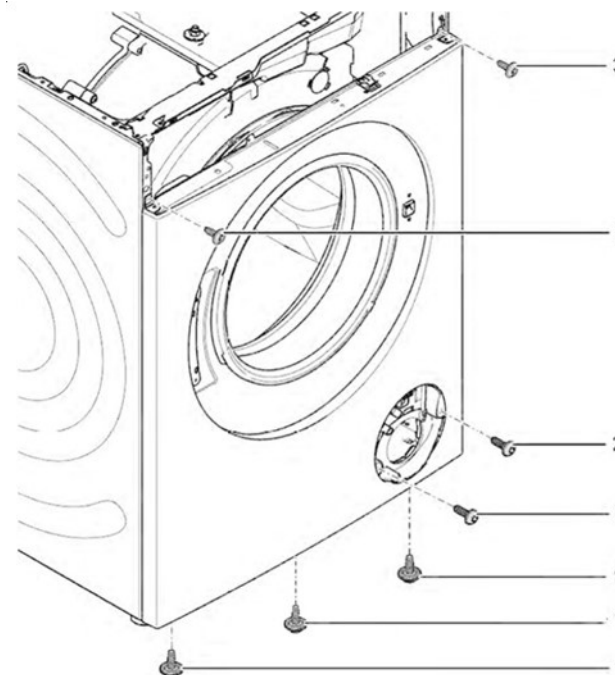

3. Sänk ner maskinen.

Reparation

4. Ta bort skruvarna vid pumpen (2).

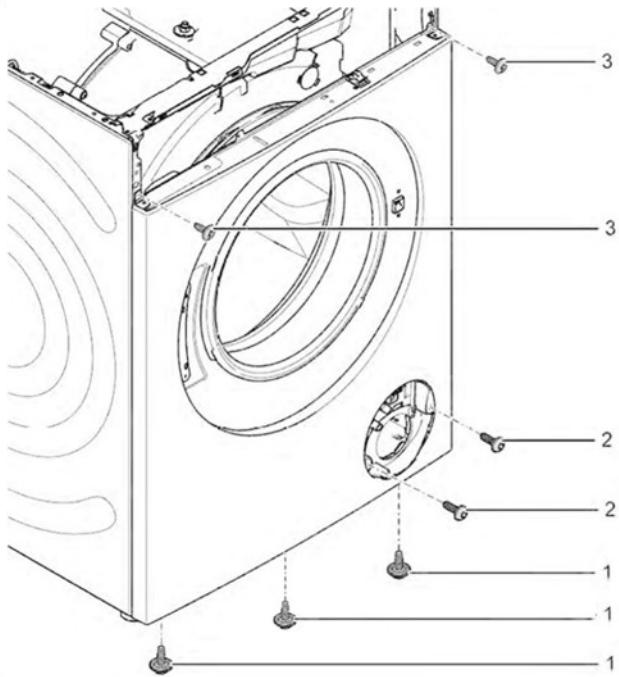

5. 1. Lossa skruvarna på maskinens baksida (1).
2. Ta bort arbetsbänken (2, 3).

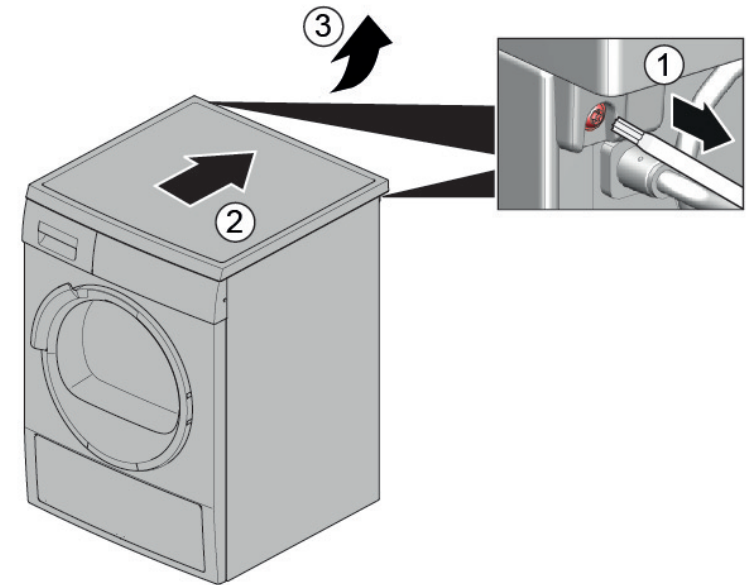

Reparation

6. 1. Ta bort skruvarna (1).
2. Lossa kontrollpanelens fästelement (2, 3).
3. Lossa skruvarna till fördelarhöljet.

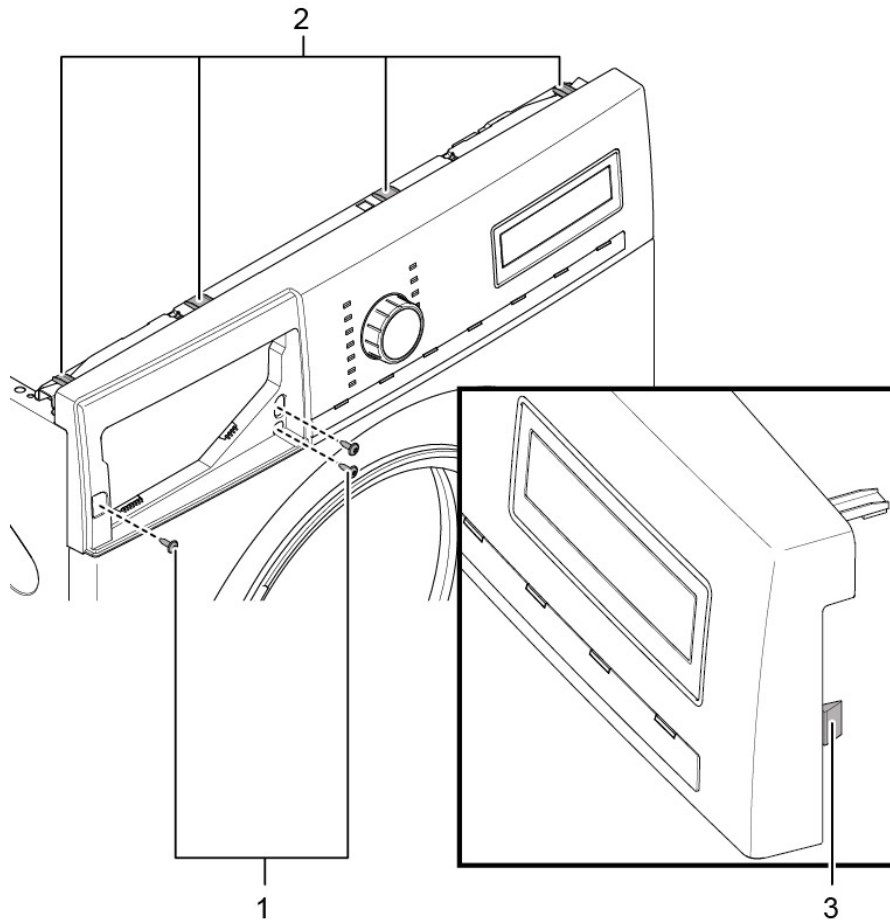

7. Ta bort kontrollpanelen.

8. Ta bort trummans lamphållare upptill.

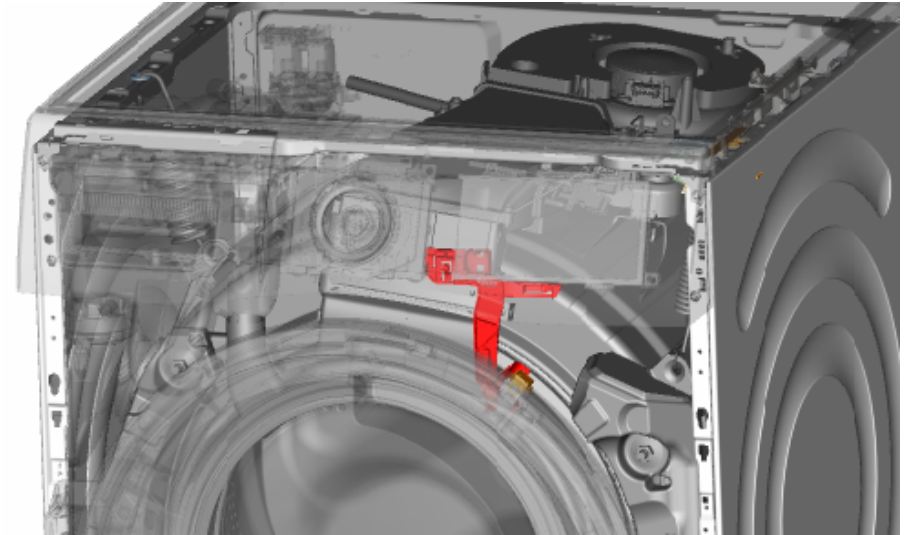

- 9.



OBS!

Risk för att ytan skadas!

Maskinens yta kan repas om fel verktyg används.

- Använd bara plastverktyg för att byta ut spänningen.

Ta bort spänningen från packningen med ett plastverktyg.

10. Lossa luckans tätning från frontpanelen.
11. Lossa kabelkontakten från luckans lås.

12. Lossa skruvarna längst upp på frontpanelen (3).

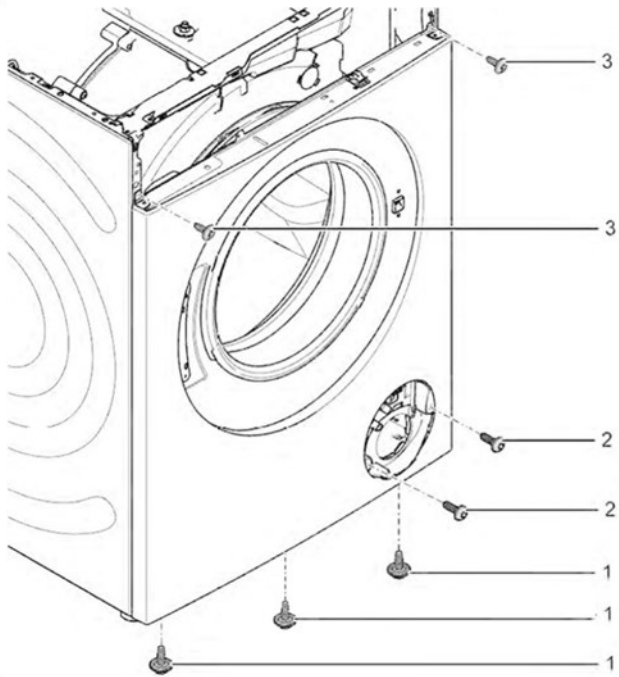

13. Ta bort frontpanelen.

14. Ta bort alla slangkopplingar.

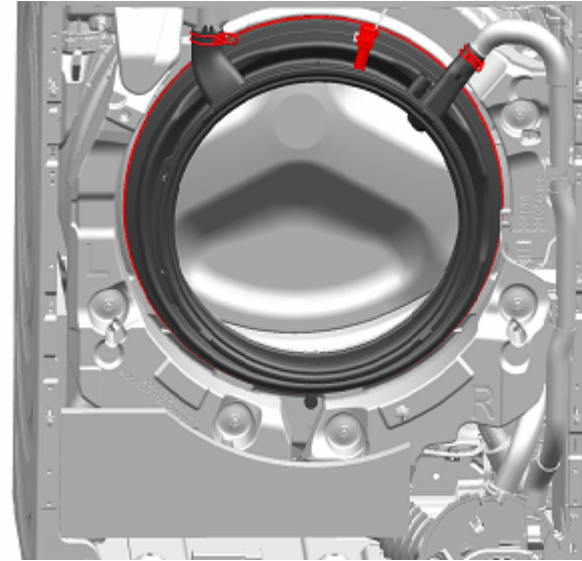

15. Ta bort luckans tätning.

4.7.2 Montera luckans tätning



! VARNING!

Risk för fallande delar på grund av felaktig montering!
Personskador eller maskinskador.

► Dra åt lucktätningens spänning med 3,4 Nm.

► Montera i omvänd ordning.

4.8 Byta luckans lås

Som tillverkare är vi ålagda att för våra kunder tillhandahålla reservdelen lucklås inklusive reparationsanvisningar i enlighet med förordning (EU) 2019/2023. Vi vill dock påminna om att det efter byte av luckans lås krävs ett elsäkerhetstest utfört av behörig elektriker innan maskinen tas i bruk igen. Denna person måste vara verifierbart behörig enligt det aktuella landets lagar, bestämmelser och standarder.

	<p>FARA!</p> <p>Risk för elstötar på grund av strömförande delar! Livsfara på grund av elstötar vid felaktiga reparationer</p> <ul style="list-style-type: none">▶ Elektriska delar ska repareras av behörig elektriker.▶ Låt utföra ett säkerhetstest efter reparationen, i enlighet med VDE 0701 eller landsspecifika regler.
--	--

	<p>FÖRSIKTIGT!</p> <p>Vassa höljeskanter! Skärskador</p> <ul style="list-style-type: none">▶ Använd skyddshandskar.
--	---

	<p>VARNING!</p> <p>Lutande maskiner kan glida! Frakturer/krosskador</p> <ul style="list-style-type: none">▶ Säkra maskiner så att de inte kan glida.
--	--

	<p>FÖRSIKTIGT!</p> <p>Risk för fallande delar på grund av lossade skruvar! Personskador på grund av fallande delar.</p> <ul style="list-style-type: none">▶ Säkra komponenter så att de inte faller ner.
---	--

	<p>OBS!</p> <p>Risk för fallande delar på grund av lossade skruvar! Materiella skador på andra delar av maskinen eller i kundens hem, t.ex. vid botten.</p> <ul style="list-style-type: none">▶ Säkra komponenter så att de inte faller ner.
--	--

Förutsättning:

- ✓ Apparaten är bortkopplad från strömförsörjning.
- ✓ Apparaten är bortkopplad från vattenförsörjning.

- ✓ Maskinen är fritt åtkomlig.
- ✓ [Arbetsbänken har tagits bort.→491](#)
- ✓ Kontrollpanelen har tagits bort.
- ✓ [Luckan har tagits bort.→495](#)
- ✓ Spännringen har tagits bort.
- ✓ Frontpanelen har tagits bort.
- ✓ Luckans tätning har tagits bort.

4.8.1 Ta bort luckans lås

1. Dra ur kontakten till luckans lås.
2. Lossa luckans lås.



3. Ta bort luckans lås.

4.8.2 Montera luckans lås

Luckans lås måste vara i rätt läge för att maskinens nödöppning av luckan ska fungera.

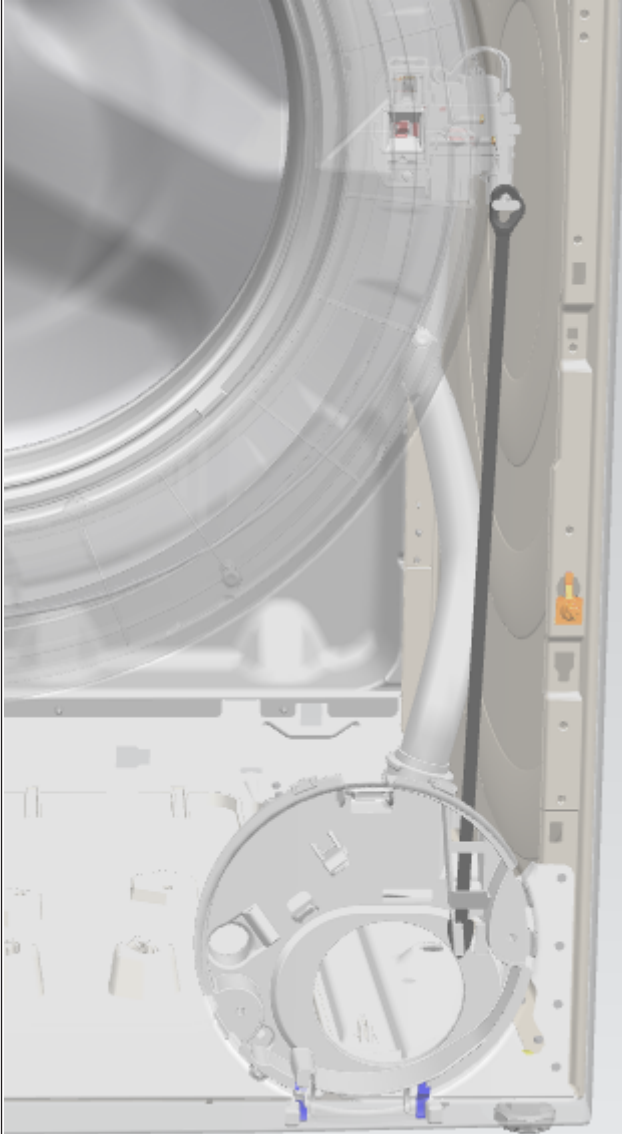

- ▶ Montera i omvänd ordning.

4.9 Byta trummans lampa



⚠️ FÖRSIKTIGT!

Vassa höljeskanter!
Skärskador
▶ Använd skyddshandskar.



⚠️ VARNING!

Lutande maskiner kan glida!
Frakturer/krosskador
▶ Säkra maskiner så att de inte kan glida.



⚠️ FÖRSIKTIGT!

Risk för fallande delar på grund av lossade skruvar!
Personskador på grund av fallande delar.
▶ Säkra komponenter så att de inte faller ner.



OBS!

Risk för fallande delar på grund av lossade skruvar!
Materiella skador på andra delar av maskinen eller i kundens hem, t.ex. vid botten.
▶ Säkra komponenter så att de inte faller ner.

Förutsättning:

- ✓ Apparaten är bortkopplad från strömförsörjning.
- ✓ Apparaten är bortkopplad från vattenförsörjning.
- ✓ Maskinen är fritt åtkomlig.
- ✓ [Arbetsbänken har tagits bort.→491](#)
- ✓ [Tvättmedelsfacket har tagits bort.→493](#)
- ✓ Kontrollpanelen har tagits bort.

4.9.1 Ta bort trummans lampa

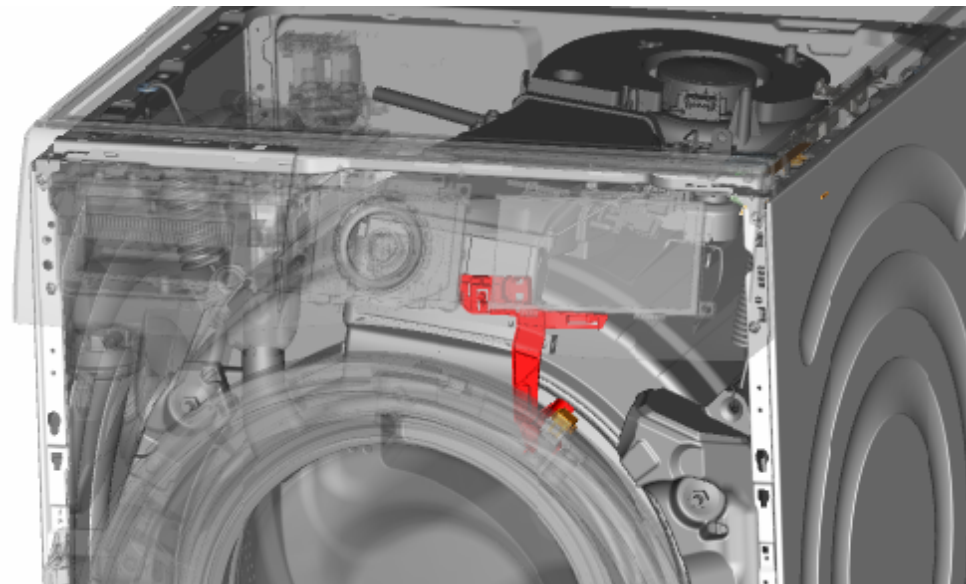

1. Dra ut trummans lampa från maskinen.
2. Lossa elanslutningarna.
3. Ta bort trummans lampa från lamphållaren.

4.9.2 Montera luckans lampa

- ▶ Montera i omvänd ordning.

4.10 Byta pumphölje

Förutsättning:

- ✓ Apparatens är bortkopplad från strömförsörjning.
- ✓ Apparatens är bortkopplad från vattenförsörjning.

4.10.1 Ta bort pumphölje

1. Öppna pumphöljet.

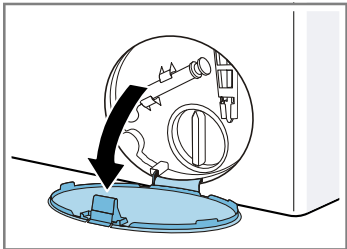

2. Ta bort pumphöljet.

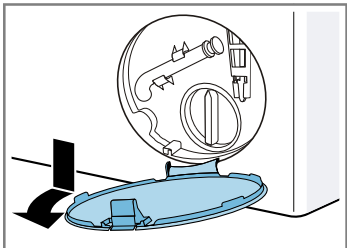

4.10.2 Montera pumphölje

- ▶ Montera i omvänd ordning.

4.11 Byta frontpanel



FÖRSIKTIGT!

Vassa höljeskanter!
Skärskador
▶ Använd skyddshandskar.

Förutsättning:

- ✓ Apparaten är bortkopplad från strömförsörjning.
- ✓ Apparaten är bortkopplad från vattenförsörjning.
- ✓ [Tvättmedelsfacket har tagits bort.→493](#)
- ✓ [Luckan har tagits bort.→495](#)
- ✓ Luckans tätning har tagits bort.
- ✓ [Pumphöljet har tagits bort.→504](#)

4.11.1 Ta bort frontpanel

1.



VARNING!

Lutande maskiner kan glida!
Frakturer/krosskador
▶ Säkra maskiner så att de inte kan glida.

Lyft upp maskinen framtill.

2. Ta bort skruvarna längst ner (1).

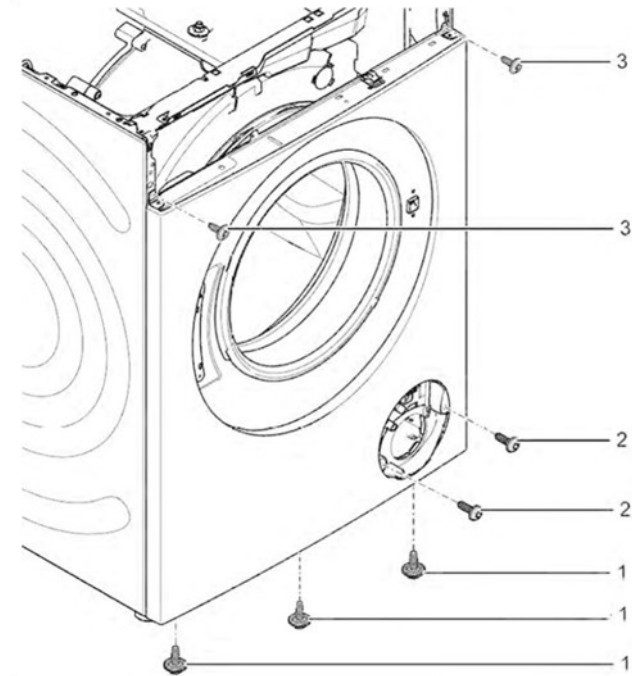

3. Sänk ner maskinen.

Reparation

4. 1. Ta bort skruvarna (1).
2. Tryck arbetsbänken mot maskinens baksida (2).
3. Flytta arbetsbänken uppåt (3) för att ta bort den.

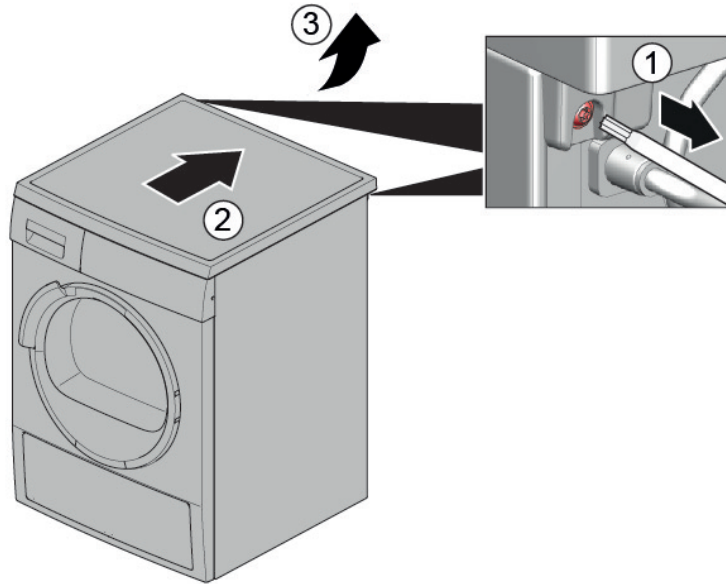

5. 1. Ta bort skruvarna (1).
2. Lossa fästelementen (2, 3).

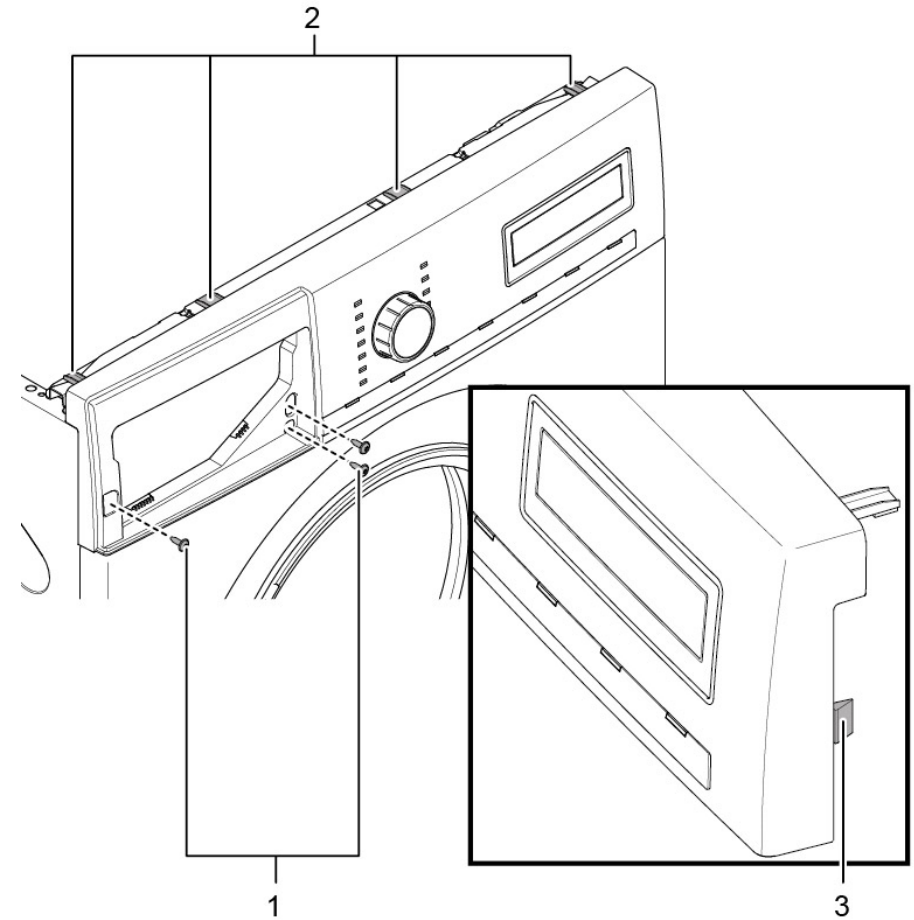

6. Ta bort kontrollpanelen.

7.



⚠ FÖRSIKTIGT!

Risk för fallande delar på grund av lossade skruvar!
Personskador på grund av fallande delar.
► Säkra komponenter så att de inte faller ner.



OBS!

Risk för fallande delar på grund av lossade skruvar!
Materiella skador på andra delar av maskinen eller i kundens hem,
t.ex. vid botten.

- ▶ Säkra komponenter så att de inte faller ner.

Ta bort skruvarna på fronten, börja nedifrån och upp (2, 3).

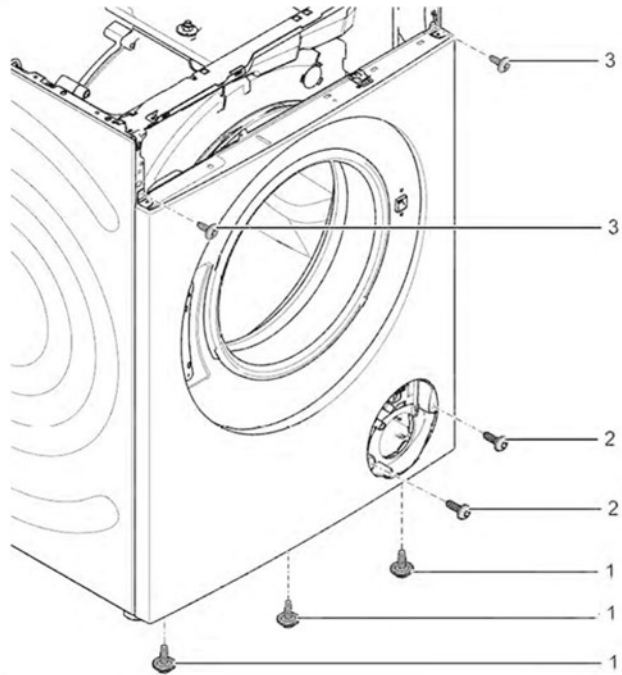

8. Ta bort frontpanelen.

4.11.2 Montera frontpanel

- ▶ Montera i omvänd ordning.

Onarım İpuçları - Çamaşır makinesi

 Bu doküman hakkında	509
1.1 Önemli bilgi	509
1.1.1 Amacı.....	509
1.2 Sembollerinin açıklaması	509
1.2.1 Tehlike kademeleri	509
1.2.2 Tehlike sembolleri	509
1.2.3 İkaz bilgilerinin yapısı	510
1.2.4 Genel semboller.....	510
 Güvenlik	511
2.1 Genel Güvenlik bilgileri	511
2.1.1 Tüm ev gereçleri	511
 Ekipman ve yardım	512
 Onarım	513
4.1 Üst tablanın değiştirilmesi	513
4.1.1 Üst tablanın sökülmesi	513
4.1.2 Üst tablanın monte edilmesi.....	513
4.2 Gösterge panelinin değiştirilmesi	514
4.2.1 Gösterge panelinin sökülmesi	514
4.2.2 Gösterge panelinin takılması.....	514
4.3 Deterjan bölmesinin değiştirilmesi.....	515
4.3.1 Deterjan bölmesinin sökülmesi.....	515
4.3.2 Deterjan bölmesinin takılması	515
4.4 Deterjan bölmesi tutamağının değiştirilmesi	516
4.4.1 Deterjan bölmesi tutamağının sökülmesi	516
4.4.2 Deterjan bölmesi tutamağının takılması	516
4.5 Kapının değiştirilmesi.....	517
4.5.1 Kapının sökülmesi.....	517
4.5.2 Kapının takılması	517
4.6 Kapı bileşenlerinin değiştirilmesi.....	518
4.6.1 Kapı bileşenlerinin sökülmesi	518
4.6.2 Kapı bileşenlerinin takılması	518
4.7 Kapı contasının değiştirilmesi	519
4.7.1 Kapı contasının sökülmesi	519
4.7.2 Kapı contasının takılması	522

4.8 Kapı kilidinin değiştirilmesi	523
4.8.1 Kapı kilidinin sökülmesi	523
4.8.2 Kapı kilidinin monte edilmesi	524
4.9 Tambur lambasının değiştirilmesi	525
4.9.1 Tambur lambasının sökülmesi	525
4.9.2 Tambur lambasının takılması	525
4.10 Pompa kapağının değiştirilmesi	526
4.10.1 Pompa kapağının sökülmesi	526
4.10.2 Pompa kapağının takılması	526
4.11 Ön panelin değişimi	527
4.11.1 Ön panelin sökülmesi	527
4.11.2 Ön sacın takılması	529

i Bu doküman hakkında

1.1 Önemli bilgi

1.1.1 Amacı

Bu onarım ipuçları, tüketicinin cihazları, geçerli eko-tasarım yönetmeliğine göre (03/2021 itibarıyla) kendi başına onarması için destek sunar.

İpuçları, ilgili uyarı ve riskler de dahil olmak üzere tanımlanmış yedek parçaların nasıl değiştirilmesi gerektiğine dair bilgiler içerir.

Sorularınız varsa, lütfen müşteri hizmetlerimizle irtibata geçin. Yalnızca onarım ipuçlarına gerektiği gibi uyulduğu takdirde hasarlar için sorumluluk üstleniriz.

1.2 Sembollerinin açıklaması

1.2.1 Tehlike kademeleri

Tehlike kademeleri bir sembolden ve bir sinyal kelimesinden oluşur. Sinyal kelimesi tehlikenin şiddetini ve önemini tanımlar.





Tehlike kademesi	Anlamı
 TEHLİKE	İkaz bilgisinin dikkate alınmaması ölüme veya ağır yaralanmalara sebep olur.
 UYARI	İkaz bilgisinin dikkate alınmaması ölüme veya ağır yaralanmalara sebep olabilir.
 DİKKAT	İkaz bilgisinin dikkate alınmaması hafif yaralanmalara sebep olabilir.
DİKKATI	İkaz bilgisinin dikkate alınmaması maddi hasarların oluşmasına sebep olabilir.

Tablo 1: Tehlike kademeleri



1.2.2 Tehlike sembolleri

Tehlike sembolleri, tehlike türü hakkında bilgi veren anlamlı resimsel gösterimlerdir.

Bu dokümanda aşağıdaki tehlike sembolleri kullanılmıştır:

Tehlike sembolü	Anlamı
	Genel ikaz bilgisi
	Elektrik geriliminden kaynaklanan tehlike
	Patlamadan kaynaklanan tehlike
	Kesmeden dolayı yaralanma tehlikesi
	Sıkışıp ezilmeden dolayı yaralanma tehlikesi

i Bu doküman hakkında

Tehlike sembolü	Anlamı
	Sıcak yüzeylerden kaynaklanan tehlike
	Güçlü elektromanyetik alan tehlikesi
	İyonizasyon olmayan ışınlardan kaynaklanan tehlike

Tablo 2: Tehlike sembolleri

1.2.3 İkaz bilgilerinin yapısı

Bu dokümandaki ikaz bilgilerinin standart olarak görünüşü ve yapısı aynıdır.



	⚠ TEHLİKE Tehlikenin türü ve kaynağı!! Tehlike / ikaz bilgisinin dikkate alınmamasının sonucu. ► Tehlikeye karşı korunmak için yapılacak işlem ve yasaklar.
--	--





Aşağıdaki örnekte, gerilim ileten parçalar nedeniyle oluşabilecek elektrik çarpması tehlikesi hakkında uyarıda bulunan bir ikaz bilgisi gösterilmiştir. Tehlikeyi önlemek için alınması gereken önlemler belirtilmiştir.

	⚠ TEHLİKE Gerilim ileten parçalar nedeniyle elektrik çarpması tehlikesi!! Elektrik çarpması sebebiyle ölüm ► Onarıma başlamadan önce cihazın elektrik şebeke bağlantısını en az 60 saniye süreyle sökün.
---	---

1.2.4 Genel semboller

Bu dokümanda aşağıdaki genel semboller kullanılmıştır:

Genel sembol	Anlamı
	Özel ipucu işareti (metin ve/veya grafik)
	Basit ipucu işareti (yalnızca metin)
	Video linki işareti

Genel sembol	Anlamı
	Gerekli araçlar işareti
	Ön koşulların işareti
	Koşul işareti (... olursa olur)
	Sonuç işareti
	Tuş veya düğme işareti
	Malzeme numarası işareti
	Gösterilen yazı / ekran işareti (cihaz ekranındaki)

Tablo 3: Genel semboller

2.1 Genel Güvenlik bilgileri

2.1.1 Tüm ev gereçleri

Gerilim ileten parçalar nedeniyle elektrik çarpması tehlikesi!

- Elektrikli bileşenlerde yapılan onarımlarda hatalar, elektrik çarpmasına neden olabilir!
- Cihaz çalışmalara başlamadan en az 60 saniye önce elektrik şebekesinden ayrılmalıdır.
- Onarım sonrasında VDE 0701 veya ülkeye özel düzenlemeler uyarınca bir güvenlik testi gerçekleştirilmelidir.

Keskin kenarlar nedeniyle yaralanma tehlikesi!

- Koruyucu eldiven kullanılmalıdır.

Ağır ve hareketli parçaların onarım, bakım, hata arama ve servis işlemlerinde yaratabileceği ezilme riskleri

- Koruyucu ayakkabı giyin.
- Yere düşmemesi için ağır parçaları emniyete alın.
- Hareketli parçaların arasına gövde parçaları koymayın.







Cihaz güvenliğinde / fonksiyonda tehlike!





- Yalnızca orijinal parçalar kullanılmalıdır.

Elektrostatik hassasiyeti olan bileşenlerde hasar tehlikesi (ESD)!

- Bağlantılar ve iletken yolları da dahil olmak üzere modüllere dokunmayın.

Ekipman ve yardım

Tanımlama	Detaylar	Görüntüler
Sabitlenme parçası [15000155]	Plastik parçaların gevşetilmesi için alet	
Delik boşluklu Torx T20 tornavida [00340764]	100 mm, emniyet pimli vidalar için	
Tork anahtarı [15000441]	Tork anahtarı 20 - 100 Nm	
Düz tornavida [00340854]	Bıçak 3,5 mm x 0,6 mm x 100 mm, Koruyucu İzolasyon 1000 V AC	
Düz tornavida [00340855]	Bıçak 5,5 mm x 1,0 mm x 125 mm, Koruyucu İzolasyon 1000 V AC	
Kargaburun pense, açılı ağızlı [00341269]	Uzunluk 200 mm	
Yan keski [00342182]	Uzunluk: 200 mm	

Tanımlama	Detaylar	Görüntüler
Kombine Anahtar [00340811]	Anahtar boyutu 10°mm, M6	
Combination wrench [00340814]	Anahtar boyutu 13°mm, M8	
Kombine Anahtar [00340817]	Anahtar boyutu 17 mm, M10	
Kombine Anahtar [15000459]	Anahtar boyutu 16°mm, M10	

4.1 Üst tablanın deęiřtirilmesi

Özel yardımcı ekipman:

- Torx Bit TX20 delikli, uzun 6.3°mm (1/4") 152°mm, emniyet pimli [00341272] vidalar için

Ön koęul:

- Cihazın fiři çekilir.
- Cihaz, su beslemesinden ayrılır.

4.1.1 Üst tablanın sökülmesi

- ▶ 1. Vidaları sökün (1).
- ▶ 2. Üst tablayı cihazın arkasına doğru itin (2).
- ▶ 3. Üst tablayı sökmek için yukarıya doğru hareket ettirin (3).

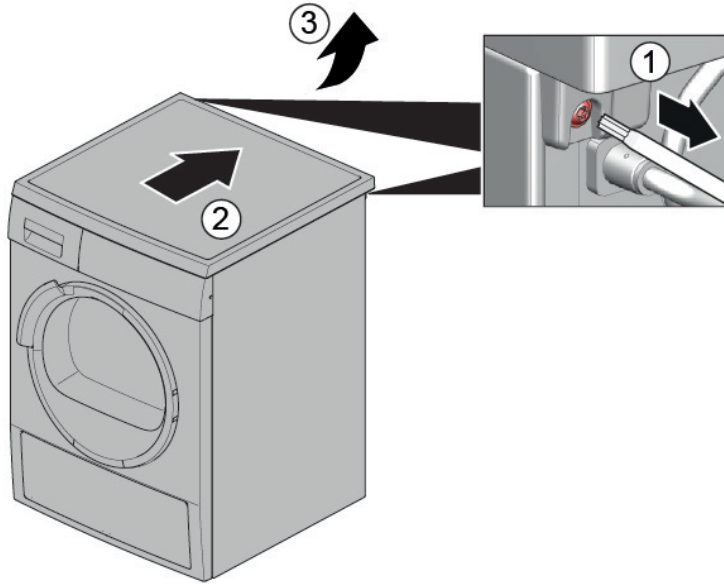

4.1.2 Üst tablanın monte edilmesi

- ▶ Ters sıra ile monte edin.

4.2 Gösterge panelinin değiştirilmesi



DİKKAT

Keskin gövde kenarları!

- Kesik yaralanmaları
- ▶ Koruyucu eldiven kullanılmalıdır.



UYARI

Eğilmiş cihazların kayması!

- Kemik kırılmaları / çarpma sonucu yaralanmalar
- ▶ Cihazları kaymaya karşı emniyete alın.



DİKKAT

Vidaların gevşetilmesi nedeniyle parçaların düşme tehlikesi!

- Düşen parçalar nedeniyle yaralanma.
- ▶ Bileşenleri düşmeye karşı emniyete alın.



DİKKAT!

Vidaların gevşetilmesi nedeniyle parçaların düşme tehlikesi!

- Cihazın diğer parçalarında veya müşterinin evinde (örn. zemin) hasarlar.
- ▶ Bileşenleri düşmeye karşı emniyete alın.

Ön koşul:

- ✓ Cihazın fişi çekilir.
- ✓ Cihaz, su beslemesinden ayrılır.
- ✓ [Çalışma plakası sökülü.](#)→513
- ✓ [Deterjan bölmesi söküldü.](#)→515

4.2.1 Gösterge panelinin sökülmesi

1. Vidaları sökün (1).
2. Tırnakları (2, 3) serbest bırakın.

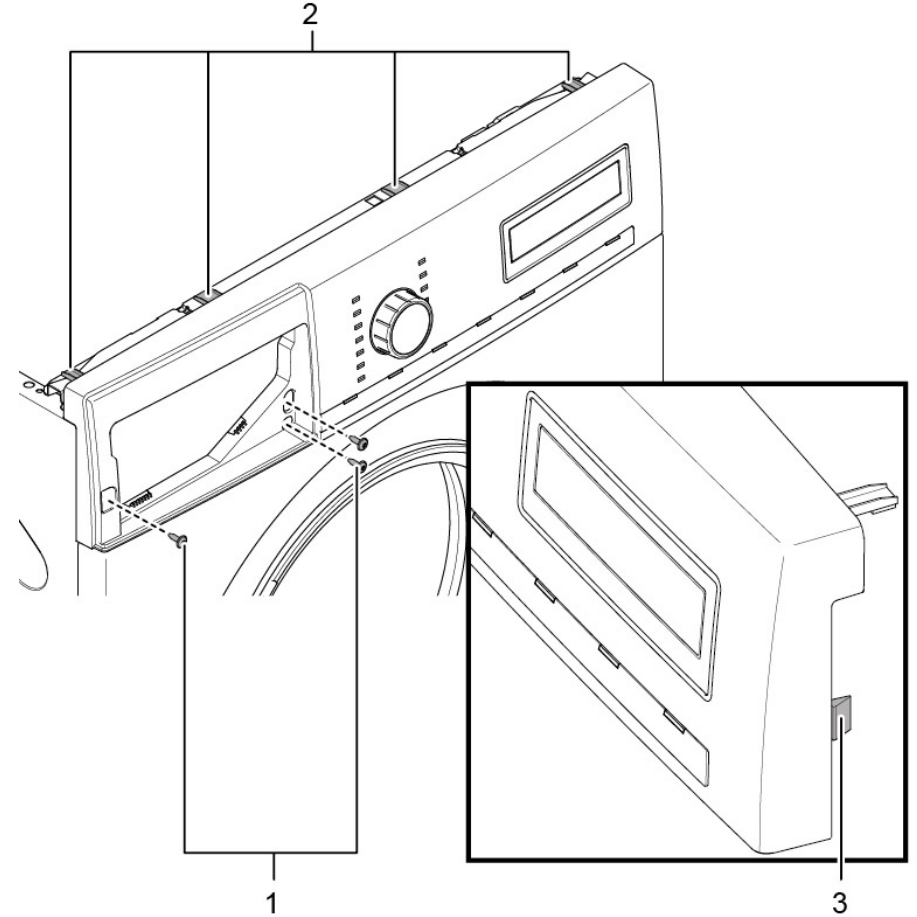

2. Kontrol ünitesinin fiş kontağını serbest bırakın.
3. Gösterge panelini sökün.

4.2.2 Gösterge panelinin takılması

- ▶ Ters sıra ile monte edin.

4.3 Deterjan bölmesinin değiştirilmesi

Ön koşul:

- ✓ Cihazın fişi çekilir.
- ✓ Cihaz, su beslemesinden ayrılır.

4.3.1 Deterjan bölmesinin sökülmesi

1. Deterjan bölmesini dışarı çekin.
2. 1. Ek parçanın üzerine bastırın (1).
2. Deterjan bölmesini sökün (2).

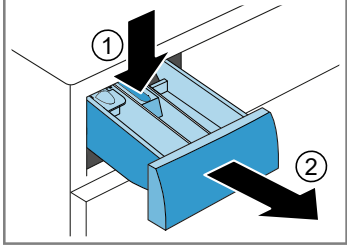

4.3.2 Deterjan bölmesinin takılması

- ▶ Ters sıra ile monte edin.

4.4 Deterjan bölmesi tutamağının değiştirilmesi

Ön koşul:

- ✓ Cihazın fişi çekilir.
- ✓ Cihaz, su beslemesinden ayrılır.
- ✓ [Deterjan bölmesi sökülüdü.→515](#)

4.4.1 Deterjan bölmesi tutamağının sökülmesi

1. Tırnakları serbest bırakın.

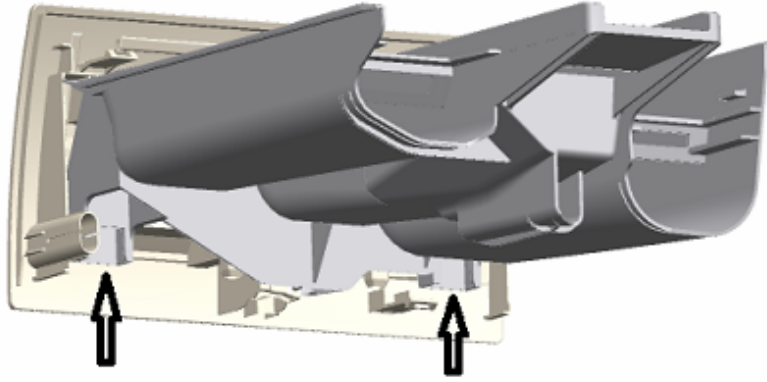

2. Deterjan bölmesi tutamağını sökün.

4.4.2 Deterjan bölmesi tutamağının takılması

- ▶ Ters sıra ile monte edin.

4.5 Kapının deęiřtirilmesi



DİKKAT

Açık menteře bölgesi!

Parmakların ezilmesi / sıkışması

- ▶ Menteře bölgesine elinizi sokmayın.
- ▶ Koruyucu eldiven kullanılmalıdır.

Ön koęul:

- ✓ Cihazın fiři çekilir.
- ✓ Cihaz, su beslemesinden ayrılır.
- ✓ Kapı açık.

4.5.1 Kapının sökülmesi

1.



DİKKAT!

Vidaların gevřetilmesi nedeniyle parçaların düşme tehlikesi!

Cihazın dięer parçalarında veya müşterinin evinde (örn. zemin) hasarlar.

- ▶ Bileřenleri düşmeye karřı emniyete alın.



DİKKAT

Vidaların gevřetilmesi nedeniyle parçaların düşme tehlikesi!

Düşen parçalar nedeniyle yaralanma.

- ▶ Bileřenleri düşmeye karřı emniyete alın.

Vidaları sökün (1).

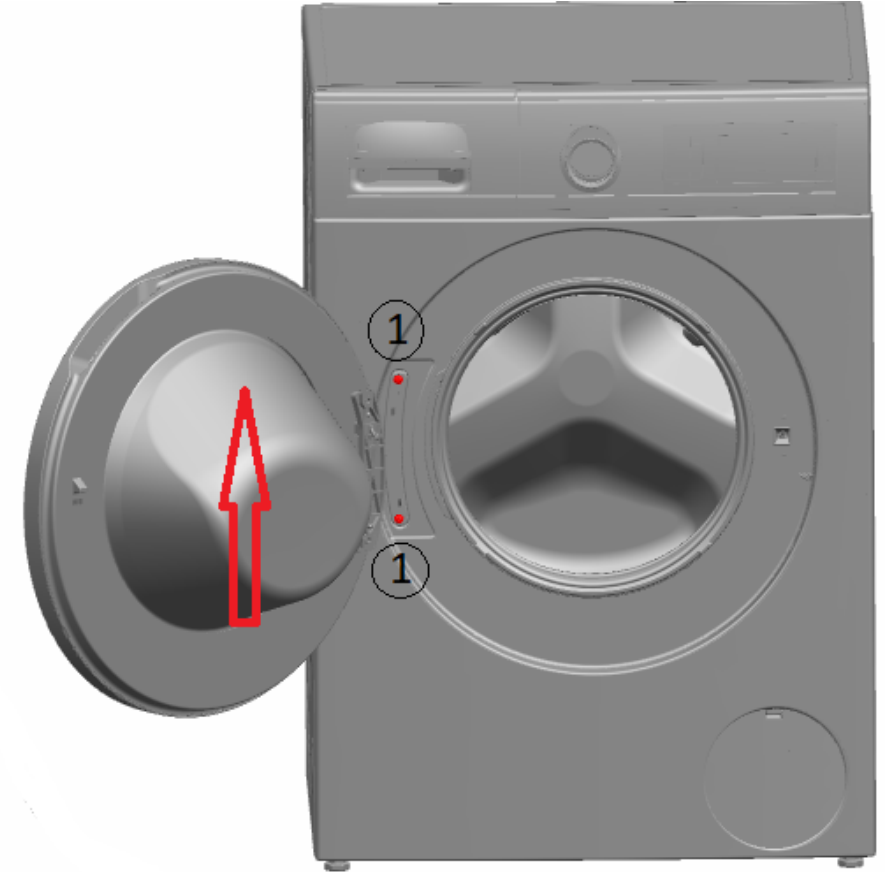

2. Kapıyı yukarıya doęru sökün.

4.5.2 Kapının takılması

- ▶ Ters sıra ile monte edin.

4.6 Kapı bileşenlerinin değiştirilmesi



DİKKAT

Açık menteşe bölgesi!

Parmakların ezilmesi / sıkışması

- ▶ Menteşe bölgesine elinizi sokmayın.
- ▶ Koruyucu eldiven kullanılmalıdır.

Ön koşul:

- ✔ Cihazın fişi çekilir.
- ✔ Cihaz, su beslemesinden ayrılır.
- ✔ [Kapı kaldırıldı.→517](#)

4.6.1 Kapı bileşenlerinin sökülmesi

- ▶ Kapıyı dıştan içe sökün.

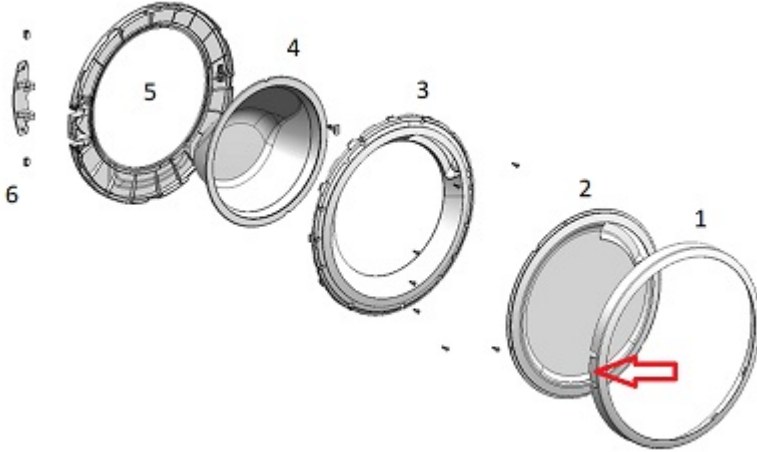

4.6.2 Kapı bileşenlerinin takılması

- ▶ Ters sıra ile monte edin.

4.7 Kapı contasının değiştirilmesi



DİKKAT

Keskin gövde kenarları!

Kesik yaralanmaları

- ▶ Koruyucu eldiven kullanılmalıdır.



DİKKAT

Vidaların gevşetilmesi nedeniyle parçaların düşme tehlikesi!

Düşen parçalar nedeniyle yaralanma.

- ▶ Bileşenleri düşmeye karşı emniyete alın.



DİKKAT!

Vidaların gevşetilmesi nedeniyle parçaların düşme tehlikesi!

Cihazın diğer parçalarında veya müşterinin evinde (örn. zemin) hasarlar.

- ▶ Bileşenleri düşmeye karşı emniyete alın.

Ön kopul:

- ✓ Cihazın fişi çekilir.
- ✓ Cihaz, su beslemesinden ayrılır.
- ✓ [Deterjan bölmesi söküldü.→515](#)
- ✓ [Kapı kaldırıldı.→517](#)
- ✓ [Pompa kapağı söküldü.→526](#)

4.7.1 Kapı contasının sökülmesi

1.



UYARI

Eğilmiş cihazların kayması!

Kemik kırılmaları / çarpma sonucu yaralanmalar

- ▶ Cihazları kaymaya karşı emniyete alın.

Cihazı önden kaldırın.

2. Ön panelin altındaki vidaları gevşetin (1).

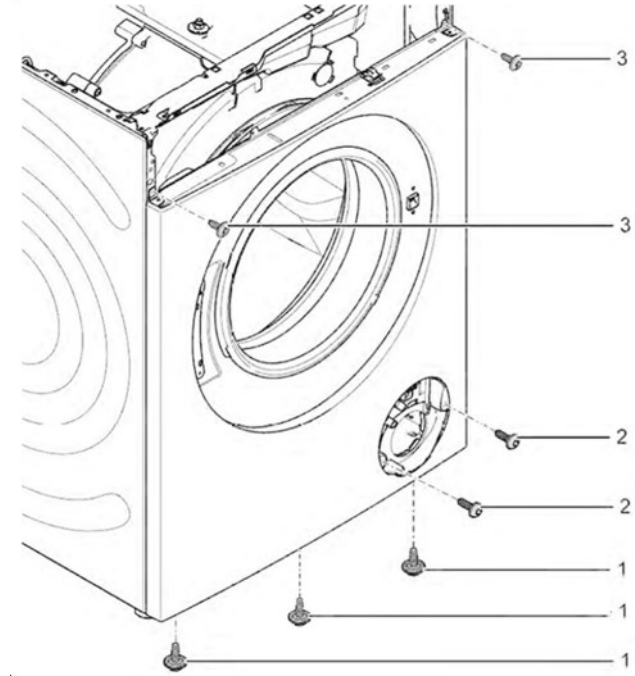

3. Cihazı indirin.

4. Pompa bölgesindeki vidaları sökün (2).

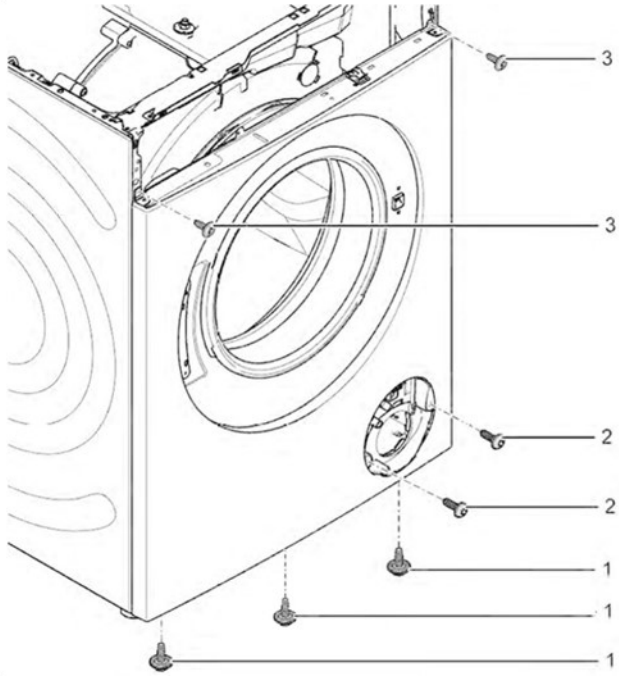

5. 1. Cihazın arkasındaki vidaları gevşetin (1).
2. Üst tablayı çıkarın (2, 3).

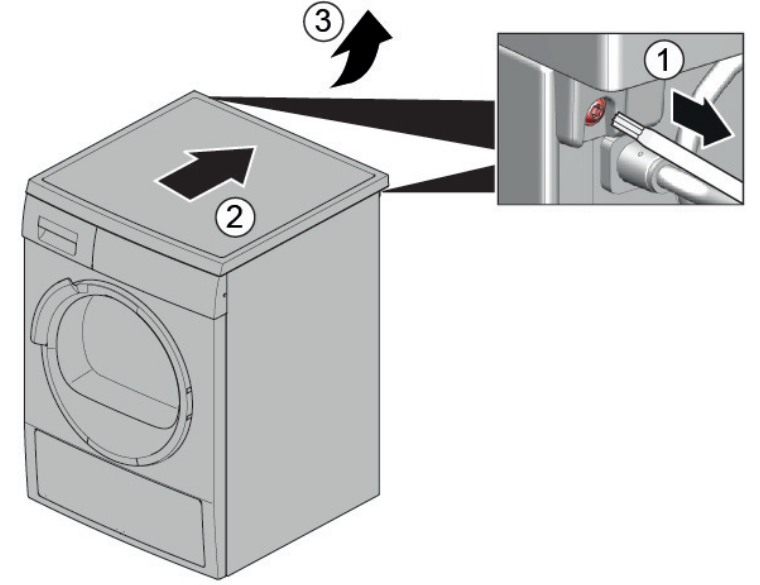

6. 1. Vidaları sökün (1).
2. Gösterge panelinin tırnaklarını serbest bırakın (2, 3).
3. Deterjan kabı muhafazasının vidalarını gevşetin.

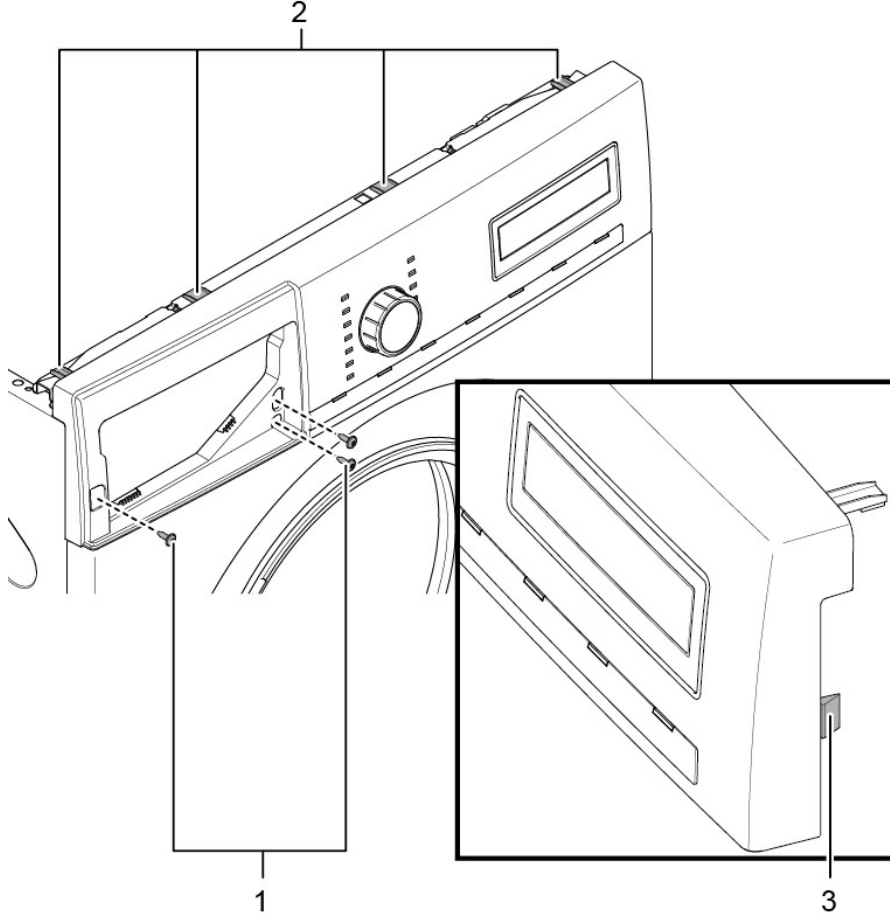

7. Gösterge panelini sökün.

8. Üst taraftaki tambur lambası tutucusunu sökün.

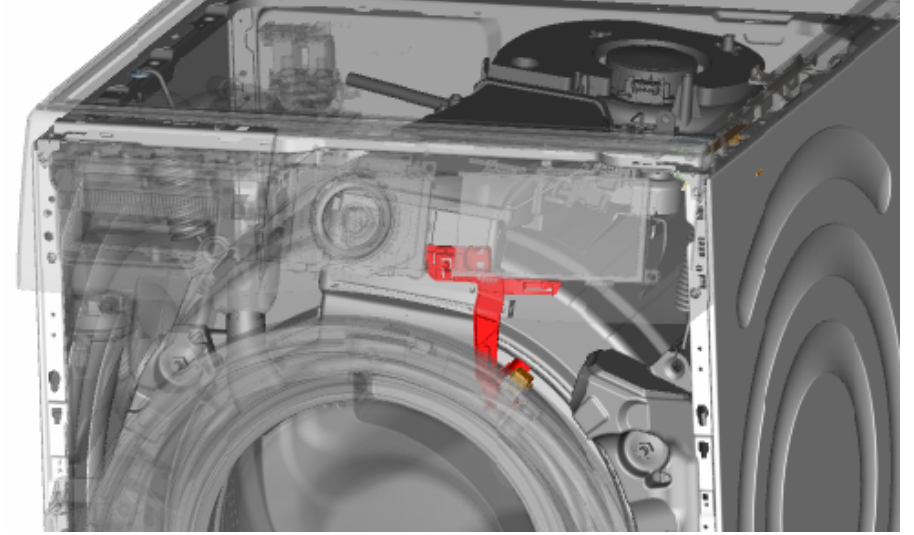

- 9.



DİKKAT!

Yüzeyin hasar görme tehlikesi!

Yanlış aletlerin kullanılması sonucu cihazın yüzeyi çizilebilir.

- ▶ Gergi halkasını değiştirmek için sadece plastik aletler kullanın.

Gergi halkasını plastik bir aletle contadan sökün.

10. Kapı contasını ön panelden çıkartın.
11. Kablo konektörünü kapı kilidinden çıkartın.

12. Ön panelin üstündeki vidaları gevşetin (3).

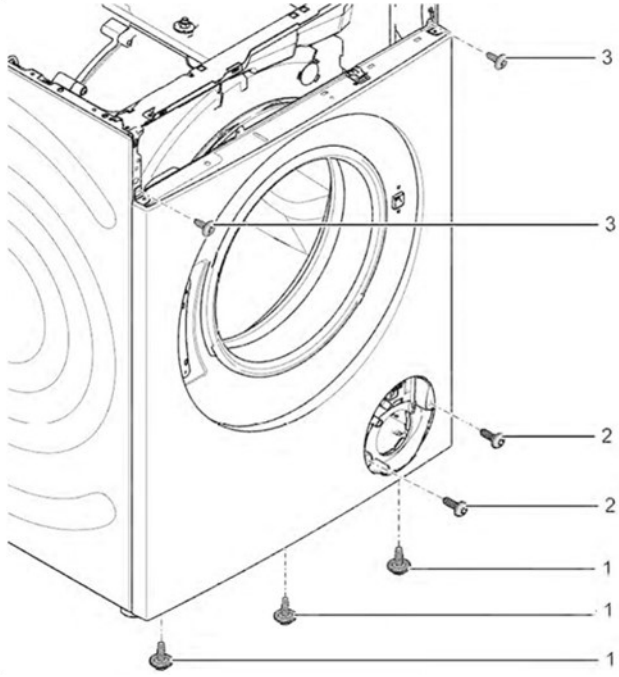

13. Ön paneli sökünüz.

14. Tüm hortum bağlantılarını ayırın.

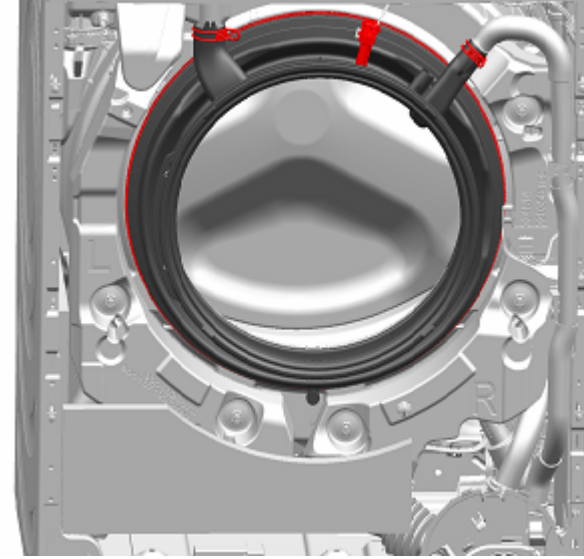

15. Kapı contasını sökün.

4.7.2 Kapı contasının takılması



 **UYARI**

Yanlış montaj nedeniyle parçaların düşmesi tehlikesi!
Yaralanma veya cihaz hasarı.

► Koruyucu kapak contasının germe halkasını 3,4 Nm ile sıkın.

► Ters sıra ile monte edin.

4.8 Kapı kilidinin değiştirilmesi

(AB) 2019/2023 Düzenlemesi uyarınca, tüketicilere onarım talimatları ile birlikte yedek bir kapı kilidinin sağlanması üretici olarak bizim yükümlülüğümüzdür. Bununla birlikte, bir kapı kilidi değişimi sonrasında cihaz çalıştırılmadan önce kalifiye bir elektrik uzmanı tarafından mutlaka bir elektroteknik güvenlik testinin gerçekleştirilmesi gerektiğini de vurgulamak isteriz. Bu kişinin ülkeye özgü yasalar, düzenlemeler ve standartlar kapsamındaki hükümlerin gerektirdiği niteliklere sahip olduğu doğrulanabilir olmalıdır.

	⚠ TEHLİKE Gerilim ileten parçalar nedeniyle elektrik çarpması tehlikesi!! Onarımın düzgün yapılması nedeniyle elektrik çarpması sonucu hayati tehlike <ul style="list-style-type: none">▶ Elektrikli parçaların onarımı kalifiye bir elektrik uzmanı tarafından gerçekleştirilmelidir.▶ Onarım sonrasında VDE 0701 veya ülkeye özel düzenlemeler uyarınca bir güvenlik testi gerçekleştirilmelidir.
--	--

	⚠ DİKKAT Keskin gövde kenarları! Kesik yaralanmaları <ul style="list-style-type: none">▶ Koruyucu eldiven kullanılmalıdır.
--	--

	⚠ UYARI Eğilmiş cihazların kayması! Kemik kırılmaları / çarpma sonucu yaralanmalar <ul style="list-style-type: none">▶ Cihazları kaymaya karşı emniyete alın.
---	---

	⚠ DİKKAT Vidaların gevşetilmesi nedeniyle parçaların düşme tehlikesi! Düşen parçalar nedeniyle yaralanma. <ul style="list-style-type: none">▶ Bileşenleri düşmeye karşı emniyete alın.
--	--

	DİKKAT! Vidaların gevşetilmesi nedeniyle parçaların düşme tehlikesi! Cihazın diğer parçalarında veya müşterinin evinde (örn. zemin) hasarlar. <ul style="list-style-type: none">▶ Bileşenleri düşmeye karşı emniyete alın.
--	--

Ön kopul:

- ✓ Cihazın fişi çekilir.

- ✓ Cihaz, su beslemesinden ayrılır.
- ✓ Cihaza serbest erişim mümkün.
- ✓ [Çalışma plakası sökülmesi.→513](#)
- ✓ Gösterge paneli söküldü.
- ✓ [Kapı kaldırıldı.→517](#)
- ✓ Geri halkası söküldü.
- ✓ Ön saç sökülmesi olmalı.
- ✓ Kapı contası söküldü.

4.8.1 Kapı kilidinin sökülmesi

1. Kapı kilidi fişini ayırın.
2. Kapı kilidini serbest bırakın.



3. Kapı kilidini sökün.

4.8.2 Kapı kilidinin monte edilmesi

Cihazın acil durum kapısının açılma işlevinin sağlanması için kapı kilidi sağ konumda olmalıdır.

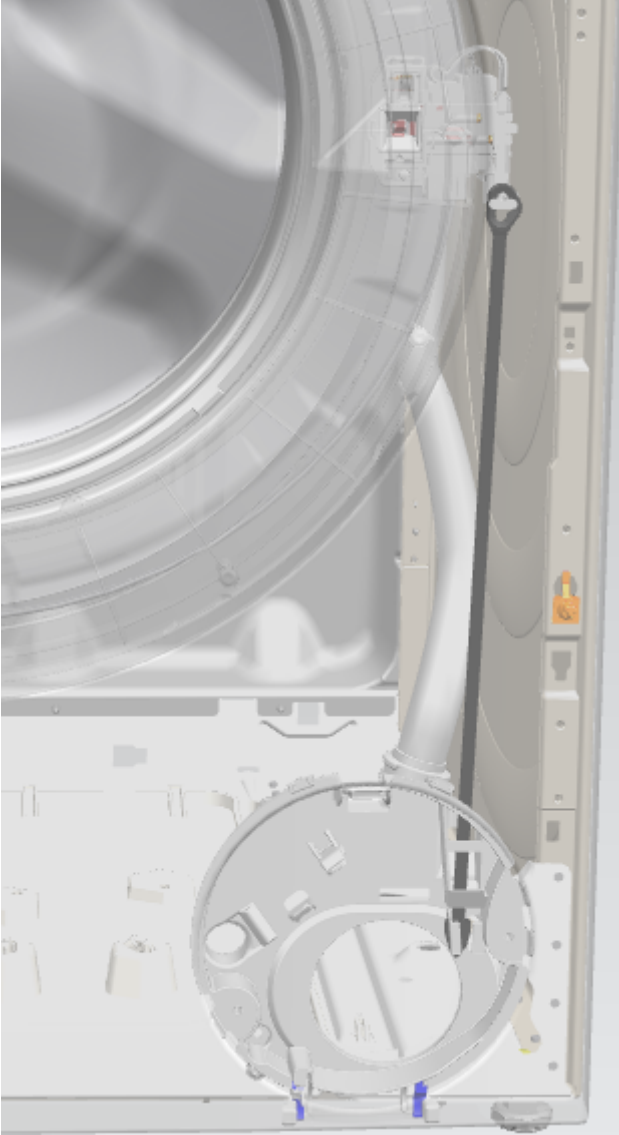

- ▶ Ters sıra ile monte edin.

4.9 Tambur lambasının deęiřtirilmesi



DİKKAT

Keskin gövde kenarları!

Kesik yaralanmaları

- ▶ Koruyucu eldiven kullanılmalıdır.



UYARI

Eęilmiş cihazların kayması!

Kemik kırılmaları / çarpma sonucu yaralanmalar

- ▶ Cihazları kaymaya karşı emniyete alın.



DİKKAT

Vidaların gevşetilmesi nedeniyle parçaların düşme tehlikesi!

Düşen parçalar nedeniyle yaralanma.

- ▶ Bileşenleri düşmeye karşı emniyete alın.



DİKKAT!

Vidaların gevşetilmesi nedeniyle parçaların düşme tehlikesi!

Cihazın diğer parçalarında veya müşterinin evinde (örn. zemin) hasarlar.

- ▶ Bileşenleri düşmeye karşı emniyete alın.

Ön koşul:

- ✓ Cihazın fiři çekilir.
- ✓ Cihaz, su beslemesinden ayrılır.
- ✓ Cihaza serbest erişim mümkün.
- ✓ [Çalışma plakası sökülmüş.→513](#)
- ✓ [Deterjan bölmesi söküldü.→515](#)
- ✓ Gösterge paneli söküldü.

4.9.1 Tambur lambasının sökülmesi

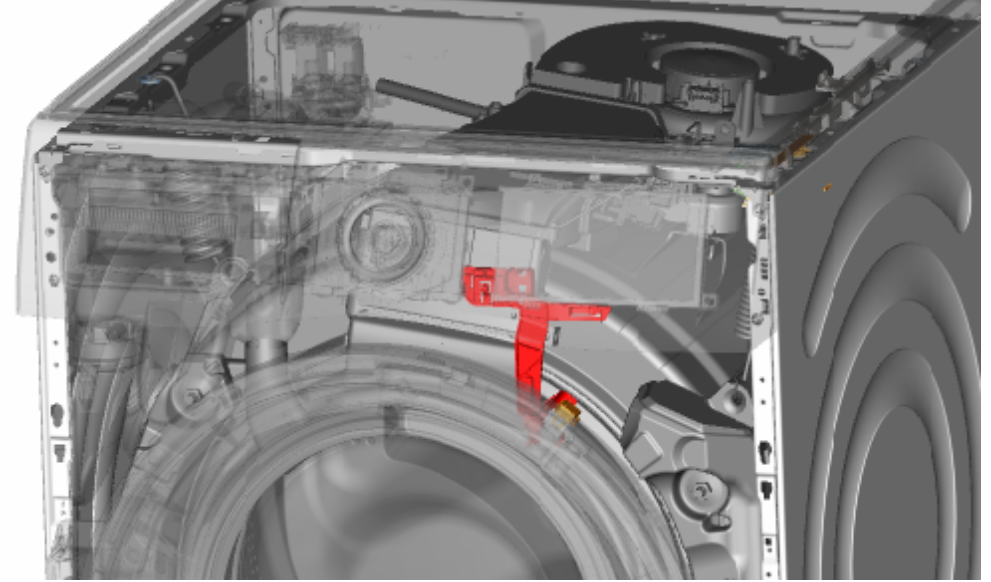

1. Tambur lambası tutucusunu cihazdan dışarı çekin.
2. Elektrik bağlantısını sökün.
3. Tambur lambasını tambur lambası tutucusundan sökün.

4.9.2 Tambur lambasının takılması

- ▶ Ters sıra ile monte edin.

4.10 Pompa kapağının değiştirilmesi

Ön koşul:

- ✓ Cihazın fişi çekilir.
- ✓ Cihaz, su beslemesinden ayrılır.

4.10.1 Pompa kapağının sökülmesi

1. Pompa kapağını açın.

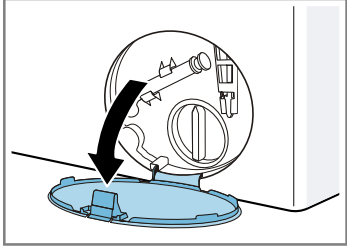

2. Pompa kapağını sökün.

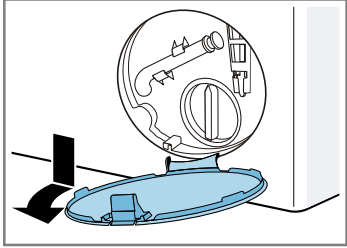

4.10.2 Pompa kapağının takılması

- ▶ Ters sıra ile monte edin.

4.11 Ön panelin değişimi



DİKKAT

Keskin gövde kenarları!

Kesik yaralanmaları

- Koruyucu eldiven kullanılmalıdır.

Ön kopul:

- ✓ Cihazın fişi çekilir.
- ✓ Cihaz, su beslemesinden ayrılır.
- ✓ [Deterjan bölmesi sökülüdü.→515](#)
- ✓ [Kapı kaldırıldı.→517](#)
- ✓ Kapı contası sökülüdü.
- ✓ [Pompa kapağı sökülüdü.→526](#)

4.11.1 Ön panelin sökülmesi

1.



UYARI

Eğilmiş cihazların kayması!

Kemik kırılmaları / çarpma sonucu yaralanmalar

- Cihazları kaymaya karşı emniyete alın.

Cihazı önden kaldırın.

2. Alt taraftaki vidaları sökün (1).

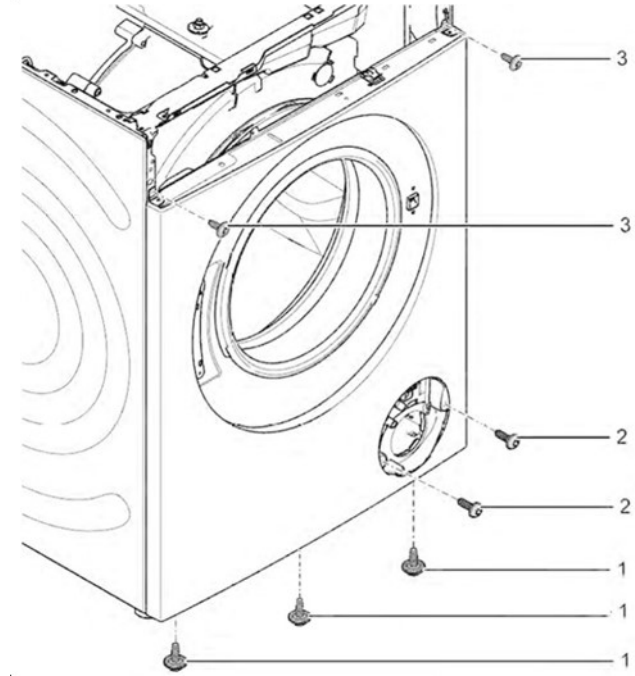

3. Cihazı indirin.

1. Vidaları sökün (1).
2. Üst tablayı cihazın arkasına doğru itin (2).
3. Üst tablayı sökme için yukarıya doğru hareket ettirin (3).

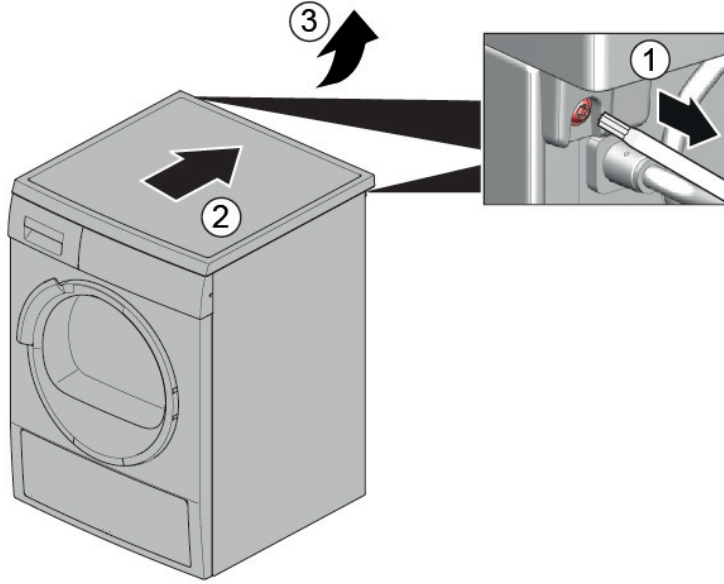

1. Vidaları sökün (1).
2. Tırnakları (2, 3) serbest bırakın.

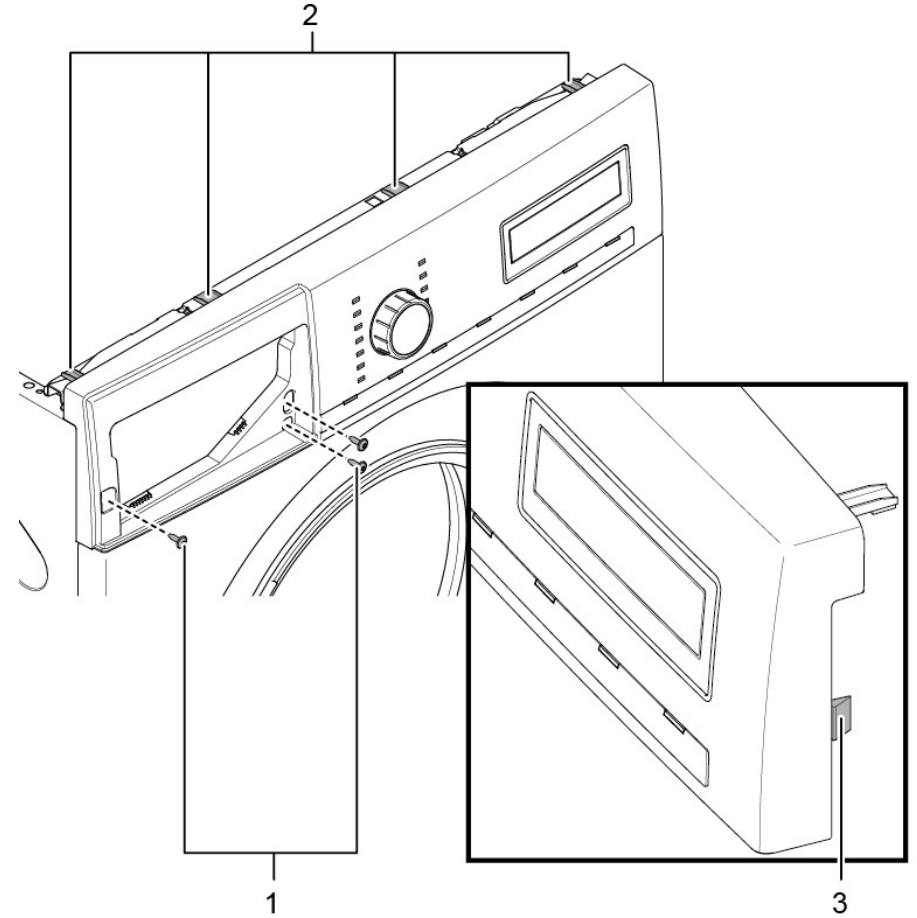

6. Gösterge panelini sökün.

7.



⚠ DİKKAT

Vidaların gevşetilmesi nedeniyle parçaların düşme tehlikesi!
Düşen parçalar nedeniyle yaralanma.
► Bileşenleri düşmeye karşı emniyete alın.



DİKKAT!

Vidaların gevşetilmesi nedeniyle parçaların düşme tehlikesi!
Cihazın diğer parçalarında veya müşterinin evinde (örn. zemin) hasarlar.

- Bileşenleri düşmeye karşı emniyete alın.

Ön taraftaki vidaları, alttan üste doğru sökün (2, 3).

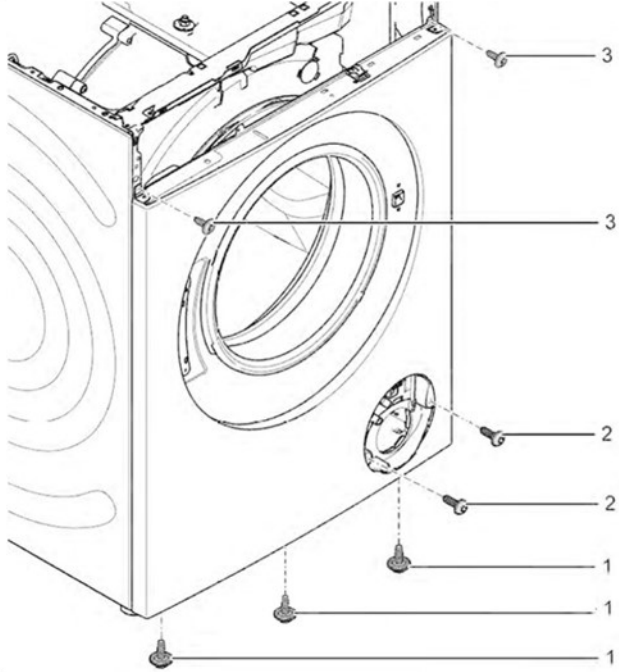

8. Ön paneli sökünüz.

4.11.2 Ön sacın takılması

- Ters sıra ile monte edin.